

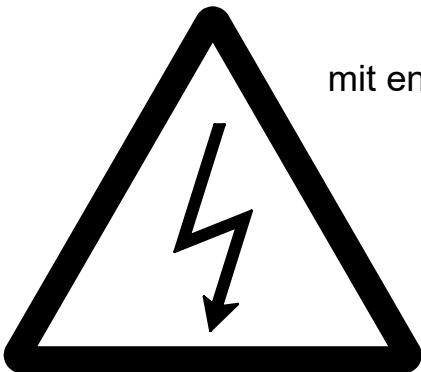

BEVOR VERKLEIDUNGSTEILE ENTFERNEN,  
DAS ERDUNGSKABEL ABSTECKEN  
BEFORE REMOVE CLADINGS,  
CLIP OUT THE EARTHING CABLE  
AVANT DE DEMONTER UN ELEMENT D'HABILLAGE,  
DEBRANCHER LE CABLE DE TERRE

**IMPORTANT:**

Zur Erfüllung der Norm, muß die Erdung gemäß  
Anweisung ausgeführt werden.  
In order to comply with earthing regulations,  
the assembly must be done as explain on this document.  
Pour être conforme à la norme, la mise à la terre  
doit être réalisée suivant la notice ci-jointe.

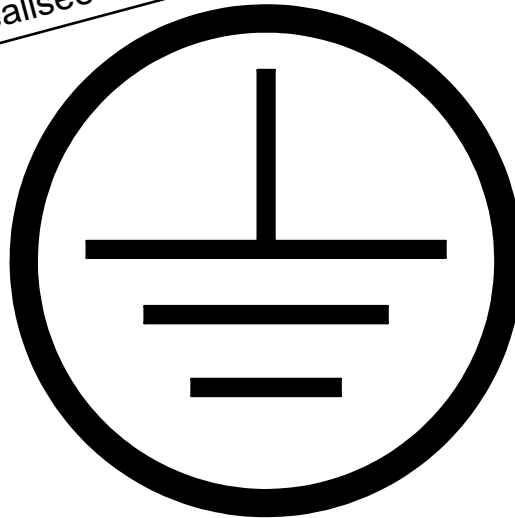

**VORSICHT LEBENSGEFAHR!**  
Elektromontage nur durch geschultem Fachpersonal  
mit entsprechender Zulassung möglich. VDE-Vorschriften beachten.

**DANGER!**  
Electrical assembly must be carried out by qualified  
staff only, according to VDE/IEEE regulations.

**ATTENTION DANGER DE MORT!**  
Montage électrique exclusivement réservé au personnel  
habilité. Respecter les prescriptions en vigueur

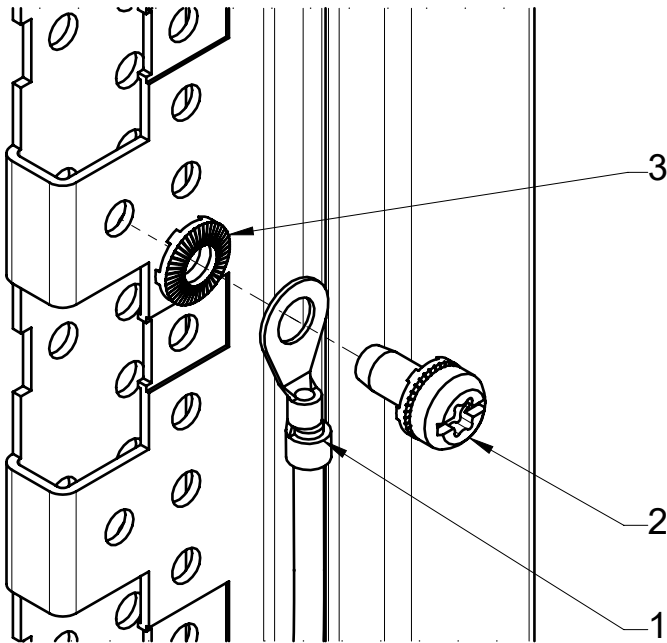
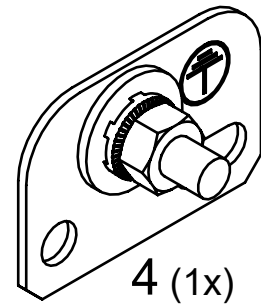
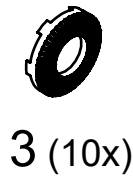
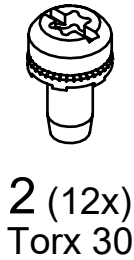
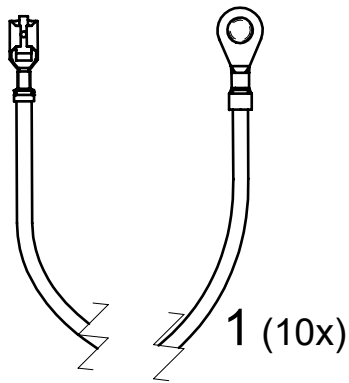

Fals folgende Montagekonfigurationen nicht benutzbar sind, möglichst nahe Befestigungslöcher verwenden.

If the following mounting configurations are not feasible, please use mountingholes as close as possible.

Si les configurations de montage suivantes ne sont pas réalisables, veuillez utiliser les trous de fixations les plus proches.

Anzugsdrehmoment:  
Tightening torque : 5 Nm ± 15%  
Couple de serrage:

Kunststoffkappe auf Erdungszunge abnehmen  
Remove plastic protection on earthing tongue  
Retirer la protection plastique de la cosse de masse

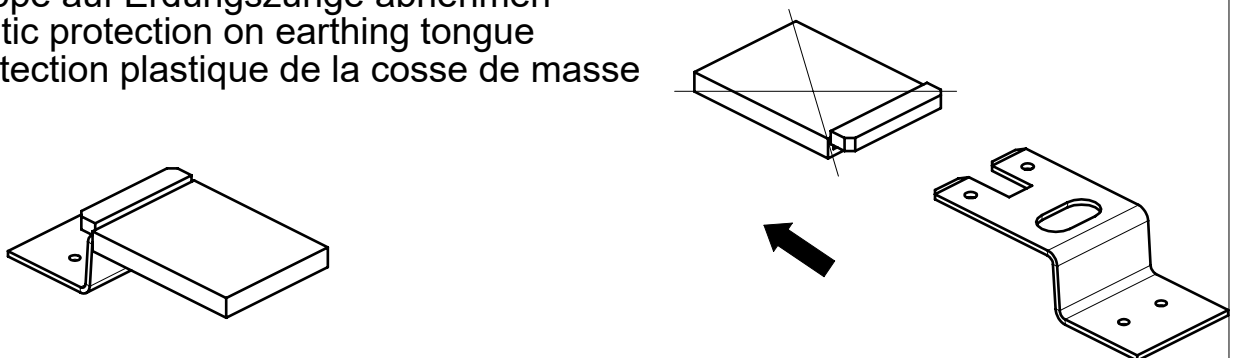

Montieren:  
Mounting:  
Montage:

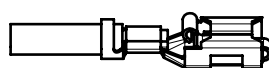

**"CLICK"**

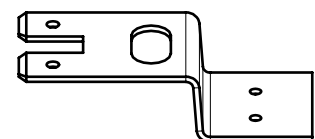

Abnehmen:  
Unmounting:  
Démontage:

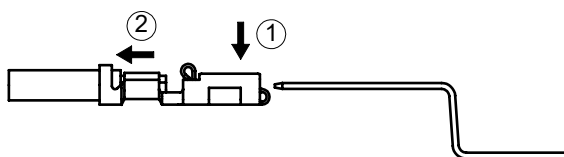

Drücken ① + Ziehen ②  
Push ① + Pull ②  
Pousser ① + Tirer ②

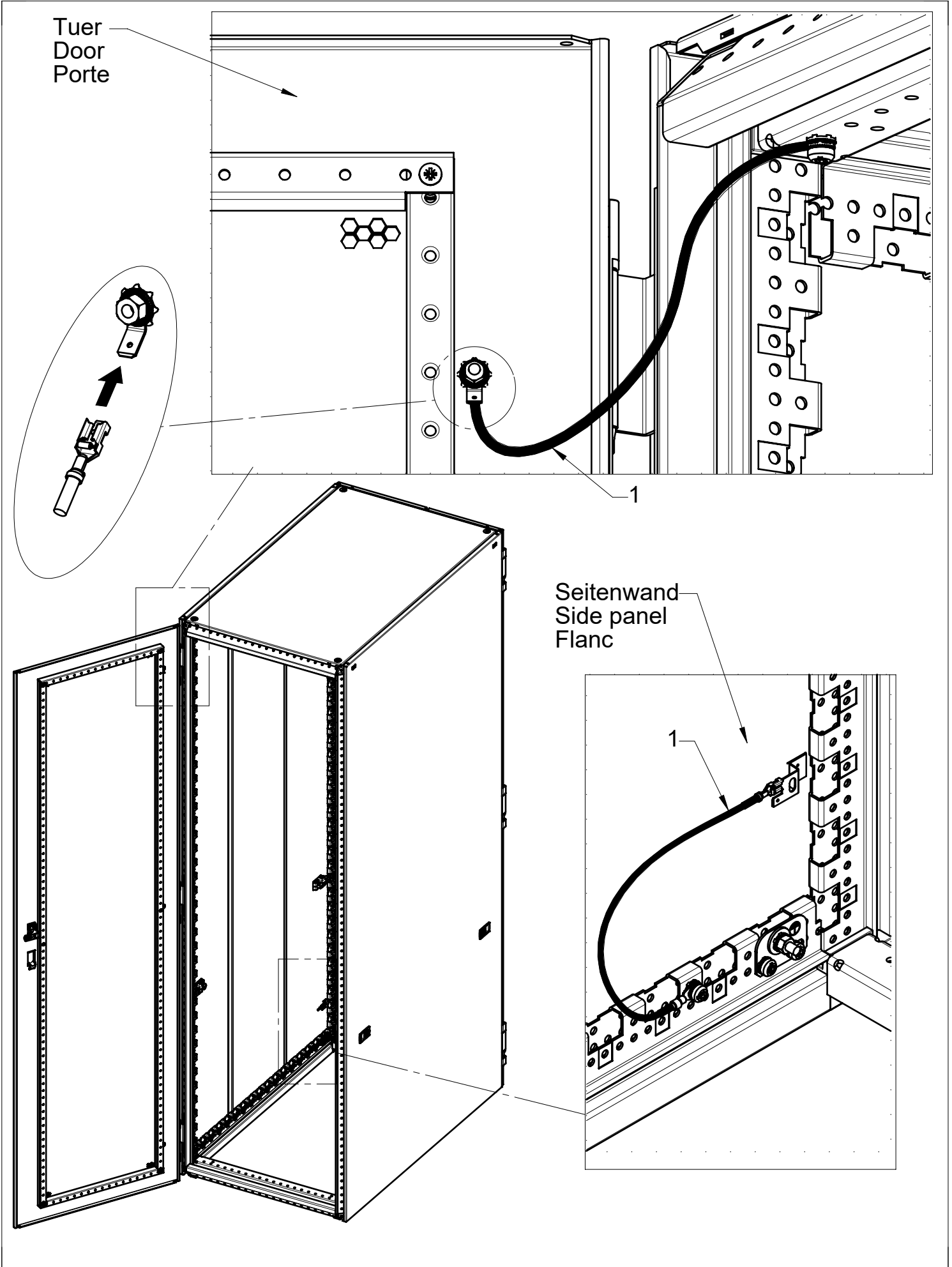

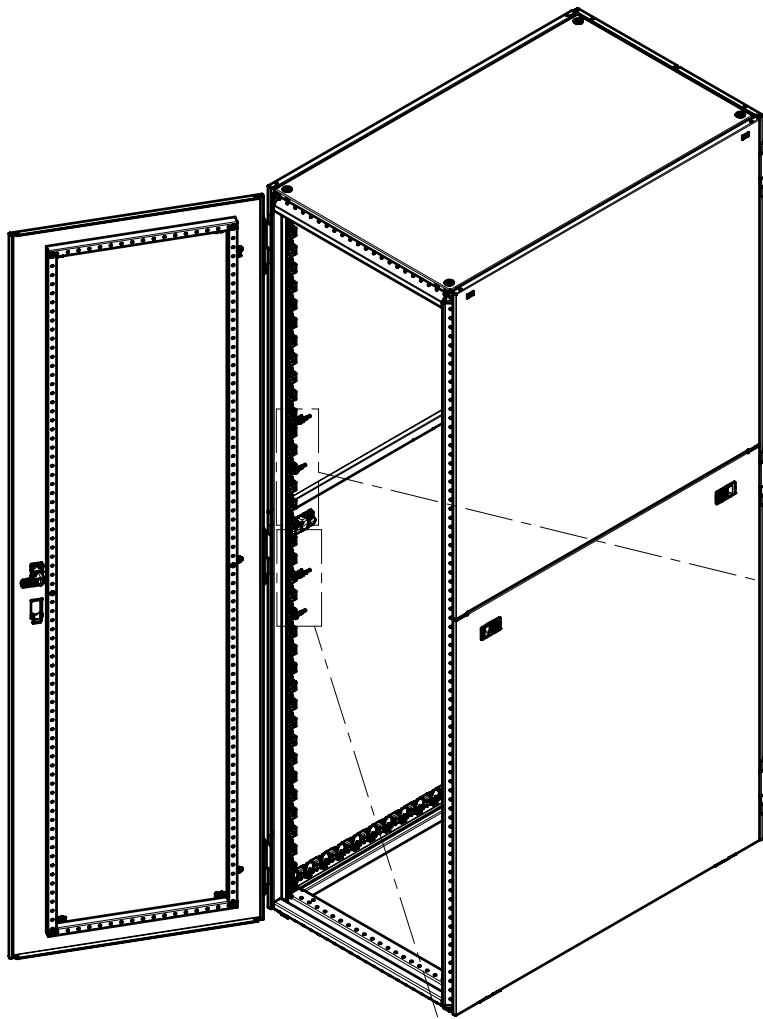

Seitenwand Oben  
Side Panel Top  
Flanc Haut

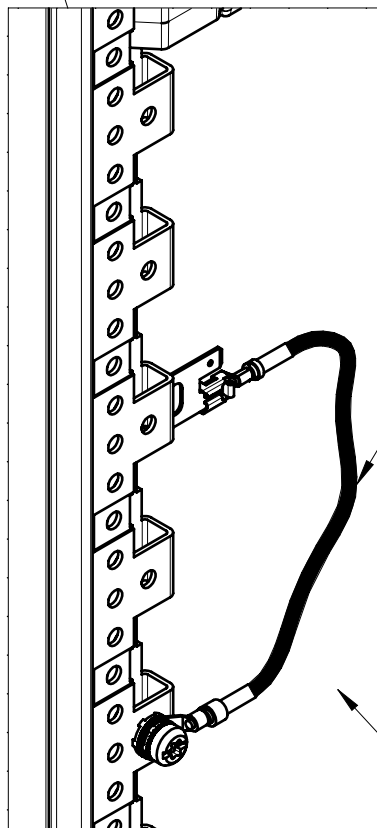
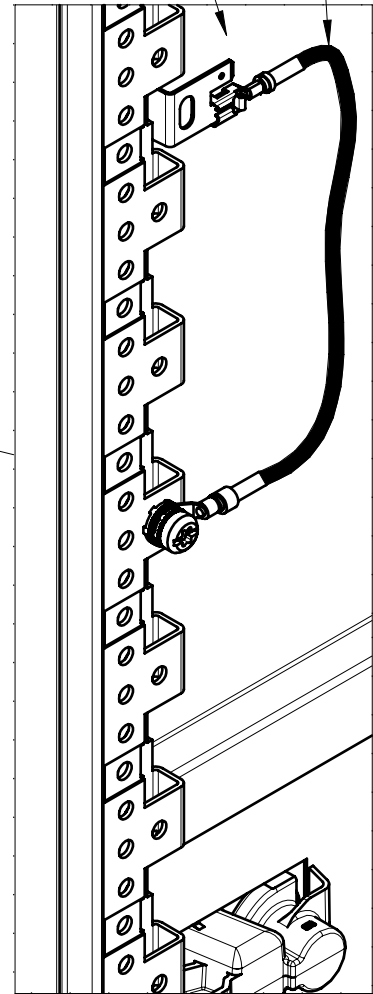

Seitenwand Unten  
Side Panel Bottom  
Flanc Bas

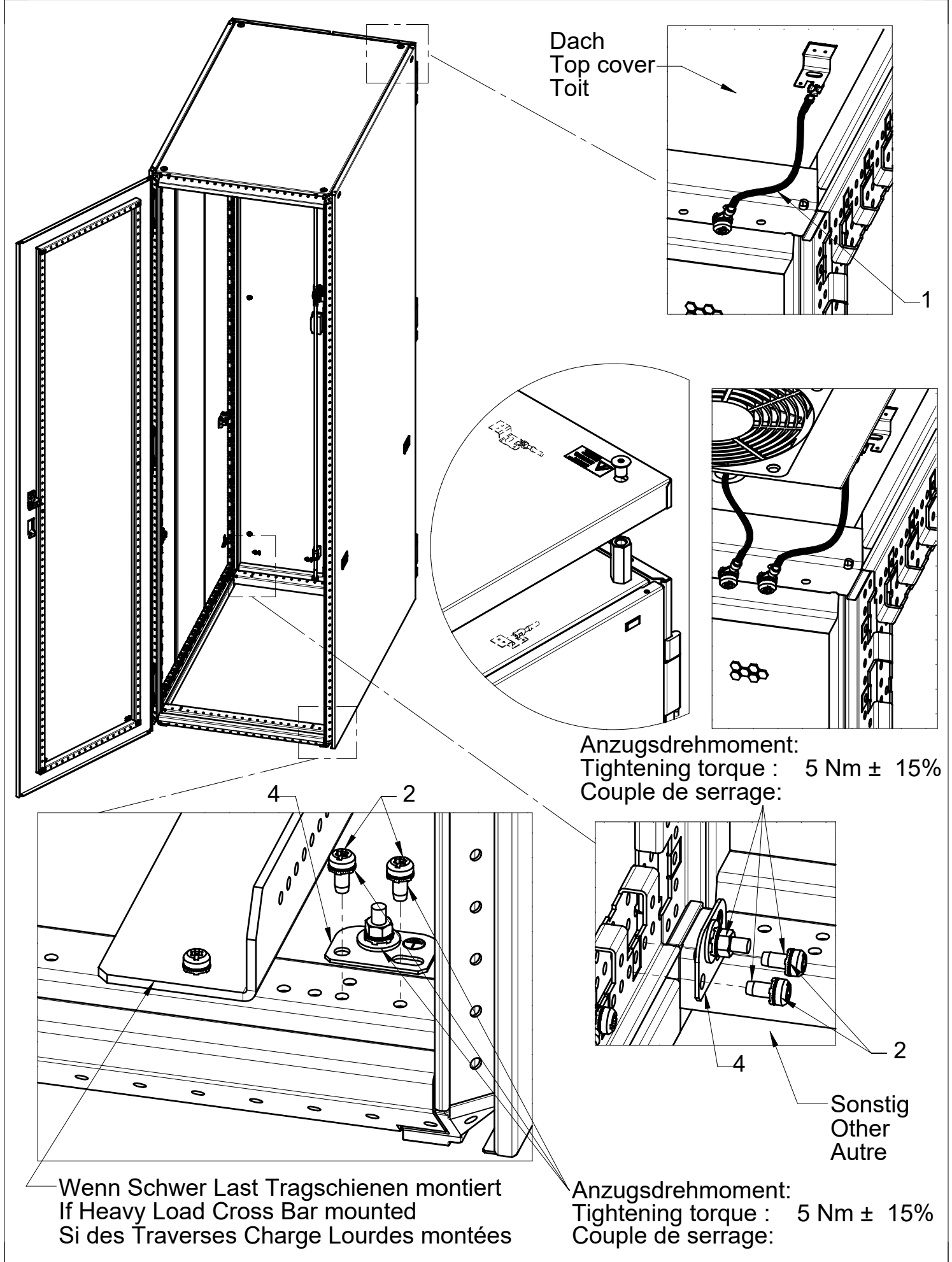

Für Standardrahmen - 600 Breite  
 For standard frames - 600 Width  
 Pour les cadres standards - 600 Largeur

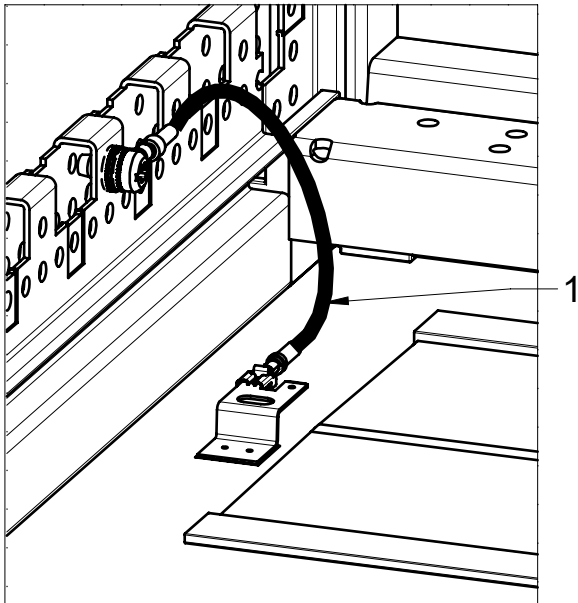

Für Standardrahmen - 800 Breite  
 For standard frames - 800 Width  
 Pour les cadres standards - 800 Largeur

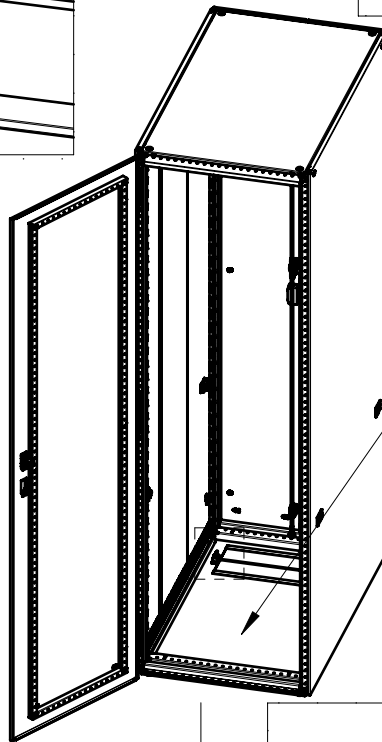
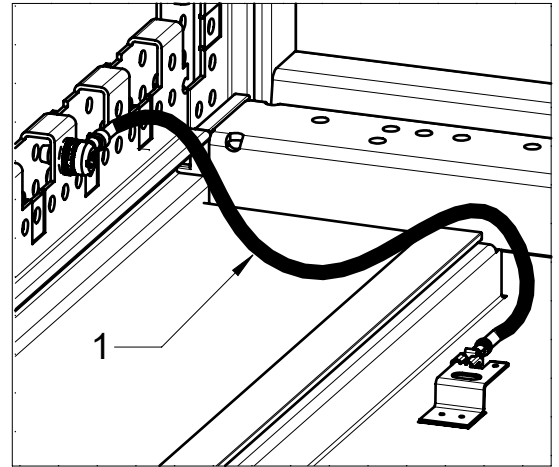

Bodenblech  
 Base plate  
 Toile de Fond

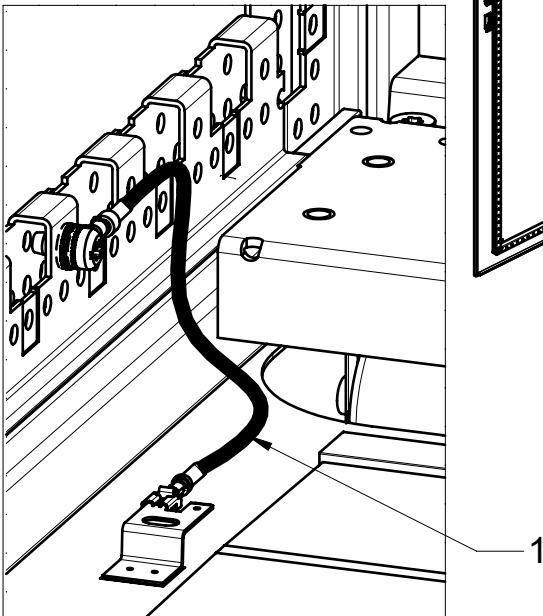

Für mobile Frames - 600 Breite  
 For mobile frames - 600 Width  
 Pour les cadres mobiles - 600 Largeur

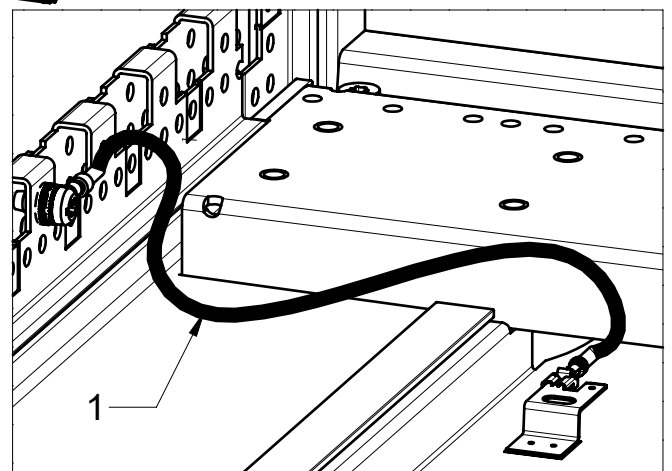

Für mobile Frames - 800 Breite  
 For mobile frames - 800 Width  
 Pour les cadres mobiles - 800 Largeur