



V-SERIES

AIR CONDITIONER

VA14 MODEL

INSTRUCTION MANUAL

TABLE OF CONTENTS

WARRANTY AND RETURN POLICY	2
RECEIVING THE AIR CONDITIONER	3
HANDLING AND TESTING THE AIR CONDITIONER.....	3
HOW TO READ MODEL NUMBERS.....	3
INSTALLATION INSTRUCTIONS	4
Dimensional Drawing	4
Mounting Cutout Dimensions.....	5
TECHNICAL INFORMATION.....	6
Sequence of Operation	6
Heating (optional).....	6
Cooling.....	6
Standard and Optional Component Operation.....	6
Thermostat	6
Head Pressure Control (optional).....	6
For cooling (35°C range):.....	6
For heating (13°C range):	6
Unit Characteristics.....	7
WIRE DIAGRAMS	8
VA14 Generic Wire Diagram (actual unit options may vary).....	8
Schematics.....	9
Components List.....	9
MAINTENANCE.....	10
Compressor	10
Inlet Air Filter	10
How To Remove, Clean or Install a New Inlet Air Filter	10
Condenser and Evaporator Air Movers.....	11
Refrigerant Loss	11
TROUBLE SHOOTING	12
Basic Air Conditioning Trouble Shooting Check List.....	12
Symptoms and Possible Causes:.....	13

WARRANTY AND RETURN POLICY

<https://hoffman.nvent.com/en/hoffman/warranty-information>

RECEIVING THE AIR CONDITIONER

Inspect the air conditioner. Check for concealed damage that may have occurred during shipment. Look for dents, scratches, loose assemblies, evidence of oil, etc. Damage evident upon receipt should be noted on the freight bill. Damage should be brought to the attention of the delivering carrier – NOT to nVent Electrical Products China – within 15 days of delivery. Save the carton and packing material and request an inspection. Then file a claim with the delivering carrier.

nVent Electrical Products China cannot accept responsibility for freight damages; however, we will assist you in any way possible.

HANDLING AND TESTING THE AIR CONDITIONER

If the air conditioner has been in a horizontal position, be certain it is placed in an upright, vertical or mounting position for a minimum of five (5) minutes before operating.

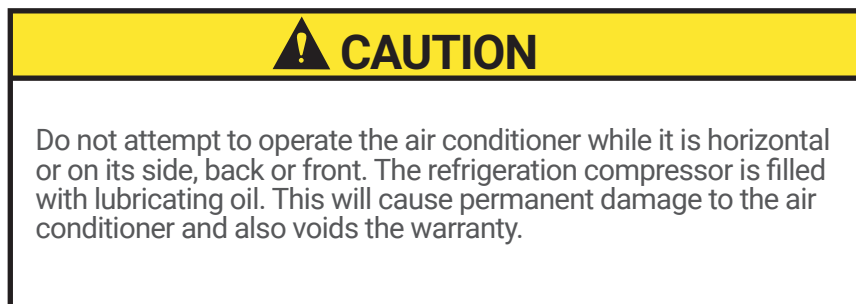

TEST FOR FUNCTIONALITY BEFORE MOUNTING THE AIR CONDITIONER TO THE ENCLOSURE.

Refer to the nameplate for proper electrical current requirements, and then connect the power cord to a properly grounded power supply. Minimum circuit ampacity should be at least 125% of the amperage shown in the design data section for the appropriate model. No other equipment should be connected to this circuit to prevent overloading.

Immediately after applying power the evaporator blower (enclosure air) should start running. Operate the air conditioner with the compressor running for five (5) to ten (10) minutes. No excessive noise or vibration should be evident during this run period. You will need to set the cooling thermostat below the ambient temperature to operate the compressor.

Condenser air temperatures should be warmer than normal room temperatures within a few minutes after the condenser impeller starts.

See sequence of operation for specifics on how the unit operates when powered up.

HOW TO READ MODEL NUMBERS

VA14	30	25	G	052	A
1	2	3	4	5	6

1. Identifies the type/family of air conditioner and the approximate height (i.e.VA14 = Value family about 1301mm to 1400mm high).
2. This is the air conditioner's listed capacity in Watt at rated conditions. (i.e. 30 = 3000 Watt at 35°C ENCLOSURE 35°C ambient.)
3. 2 = 220/230 Volt,5=50Hz.
4. Identifies the construction material and refrigerant of air conditioner.(i.e.G=Galvanized Sheet Metal and R134a).
5. Unique set of numbers for each air conditioner which identifies the accessories on a model.
6. A=The updated version

INSTALLATION INSTRUCTIONS

1. Inspect the air conditioner and verify correct functionality before mounting the air conditioner. See HANDLING AND TESTING THE AIR CONDITIONER on page 3.
2. Using the mounting gasket kit provided with the unit, install gaskets to the air conditioner, Figure 22.
3. Mount air conditioner on enclosure taking care not to damage the mounting gasket. The mounting gasket is the seal between the air conditioner and the enclosure. Avoid dragging the air conditioner on the enclosure with the mounting gasket attached as this could cause rips or tears in the gasket and risk losing the water tight seal.
4. Allow unit to remain upright for a minimum of five (5) minutes before starting. CAUTION! Air conditioner must be in upright position during operation.
5. Refer to the nameplate for electrical requirements. Wire the unit to a properly grounded power supply. Electrical circuit should be fused with slow blow or HACR circuit breaker.
6. Set thermostat for required cabinet temperature. Refer to Sequence of Operation on page 6 for thermostat adjustment and operation.

DIMENSIONAL DRAWING

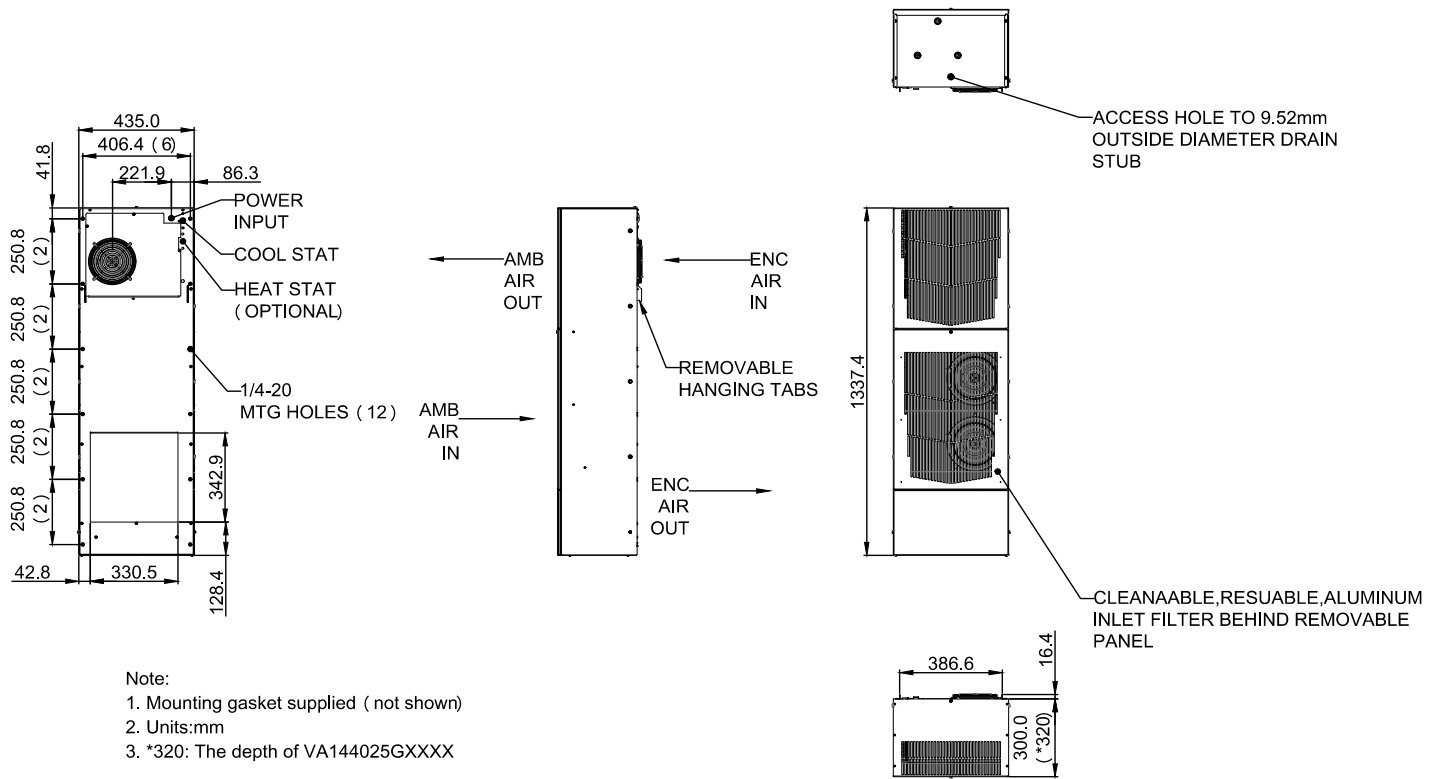

Figure 1 (External mounting dimensional drawing)

MOUNTING CUTOUT DIMENSIONS

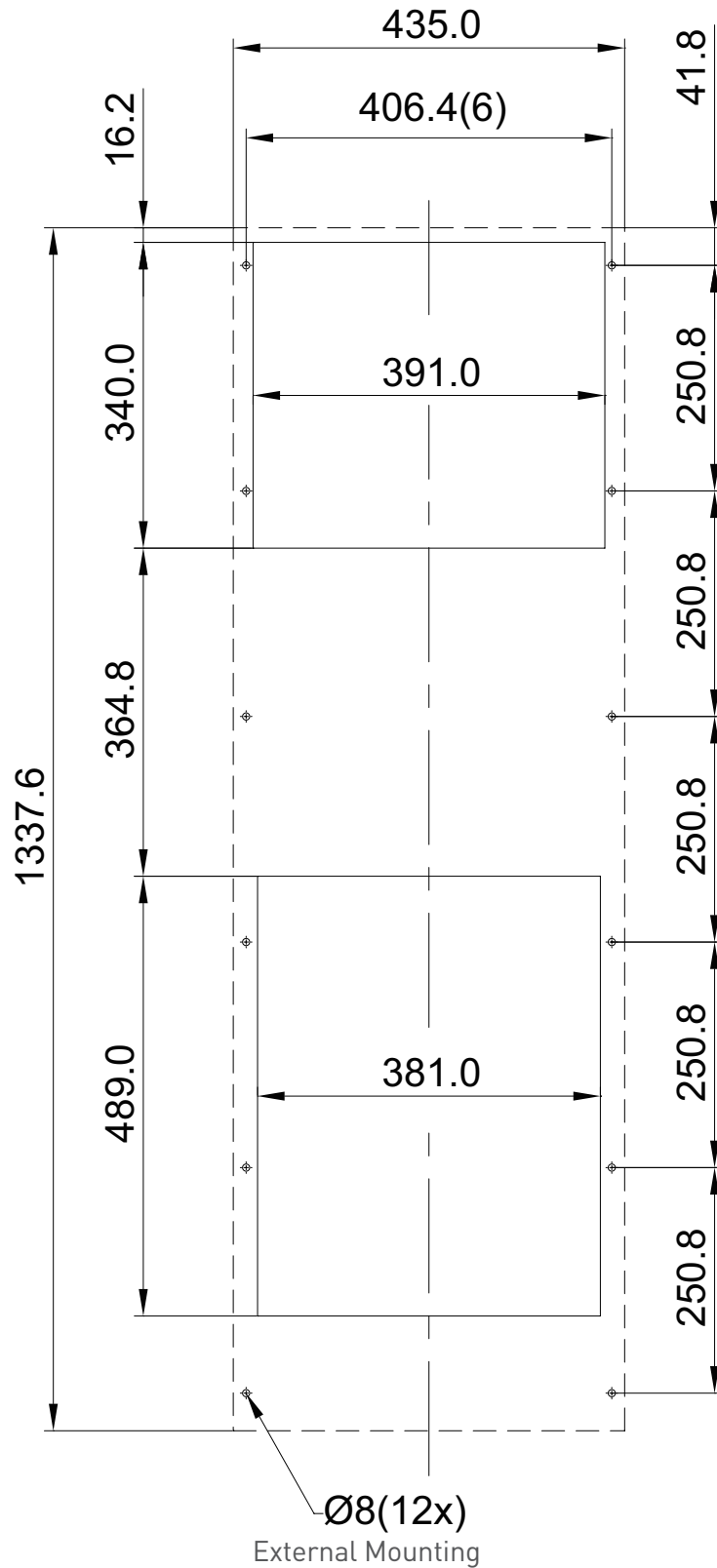

Figure 2
CUTOUT INSTRUCTIONS
(As viewed from outside of enclosure)

NOTE: Dashed lines represent air conditioner.

TECHNICAL INFORMATION

SEQUENCE OF OPERATION

The air conditioner comes standard with one internally mounted thermostat. There is one mode of operation; only cooling. During cooling mode the evaporator fan will be running.

HEATING (OPTIONAL)

When the enclosure temperature is below the heating thermostat setpoint, power is applied to the heater. When the enclosure temperature is 5°C degrees above the setpoint the heater is powered off.

COOLING

When the enclosure temperature is above the cooling thermostat setpoint, power is applied through the thermostat. The compressor is then energized either directly. The condenser impeller will start immediately if the unit is not equipped with an optional head pressure control switch. If the unit is equipped with an optional head pressure control switch, the condenser impeller will start once the refrigerant pressure reaches the setting of the switch. Component specific information is listed below.

Operating the air conditioner below the minimum ambient temperature or above the maximum ambient temperatures indicated on the nameplate voids all warranties. DO NOT set the enclosure thermostat to a temperature lower than 21°C. Doing so can increase the likelihood of frost buildup on the evaporator coil.

The moisture that the enclosure air can contain is limited. If moisture flows from the drain tube continuously, this can only mean that ambient air is entering the enclosure. Be aware that frequent opening of the enclosure's door admits humid air that the air conditioner must then dehumidify.

STANDARD AND OPTIONAL COMPONENT OPERATION

THERMOSTAT

The VA14 air conditioner uses our standard 3204580 thermostat. The thermostat setpoint equals the temperature that the air conditioner turns off. The thermostat has a 5°C differential from setpoint until it calls for cooling or heating. An example of operation is shown below.

FOR COOLING (35°C RANGE):

- Tstat setpoint = 35°C
- Cooling turns on at 40°C
- Cooling turns off at 35°C

FOR HEATING (13°C RANGE):

- Tstat setpoint = 13°C
- Heating turns on at 13°C
- Heating turns off at 18°C

NOTE: For testing purposes only, the thermostat stop screw may be removed (on units so equipped) to allow settings below 21°C. After testing, replace the stop screw and verify that the thermostat can not be set below 21°C. Extended operation below 21°C can cause coil freeze ups resulting in reduced load and/or unit damage.

HEAD PRESSURE CONTROL (OPTIONAL)

Unit is set at the factory, no adjustment necessary.

At a saturated condenser temperature of 48°C (1.14 MPa), the condenser fan will power on. At a saturated condenser temperature of 29°C (0.66 MPa), the condenser fan will power off.

UNIT CHARACTERISTICS

	Model	
	VA143025GXXXXA	VA144025GXXXXA
Dimensional Data		
Height(mm)	1338	1338
Width(mm)	435	435
Depth(mm)	300	320
Unit Weight(kg)	66	72
IP Code	IP56 internal loop IP34 external loop	IP56 internal loop IP34 external loop
Cooling Data		
Refrigerant	R134a	R134a
Refrigerant Charge (g)	1000	1200
Cooling Capacity (W),L35 L35	3176	3815
Cooling Capacity (W),L35 L50	2534	3539
Maximum Ambient Temp (°C)	55	55
Minimum Ambient Temp (°C) (Indoor/Outdoor)	20/-40	20/-40
Enclosure Airflow (m³/h)	580	870
External Airflow (m³/h)	1305	1300
Condensate Management	Hose discharge / Optional powered C/E	Hose discharge / Optional powered C/E
Heating Data (Outdoor Models)		
Capacity (W)	2000	2000
Electrical Data		
Rated Voltage (V)	230	230
Rated Frequency (Hz)	50	50
Voltage Range (V)	207-253	207-253
Power Consumption L35 L35 (W)	1326	2107
Cooling Amps at Max Conditions (A)	7.9	11.2
Starting Current (A)	26	36
Pre-fuse T (A)	20	20
Performance Factor L35 L35	2.4	2
Sound Level		
At 1 M(dBA)	71	71

WIRE DIAGRAMS

VA14 GENERIC WIRE DIAGRAM (ACTUAL UNIT OPTIONS MAY VARY)

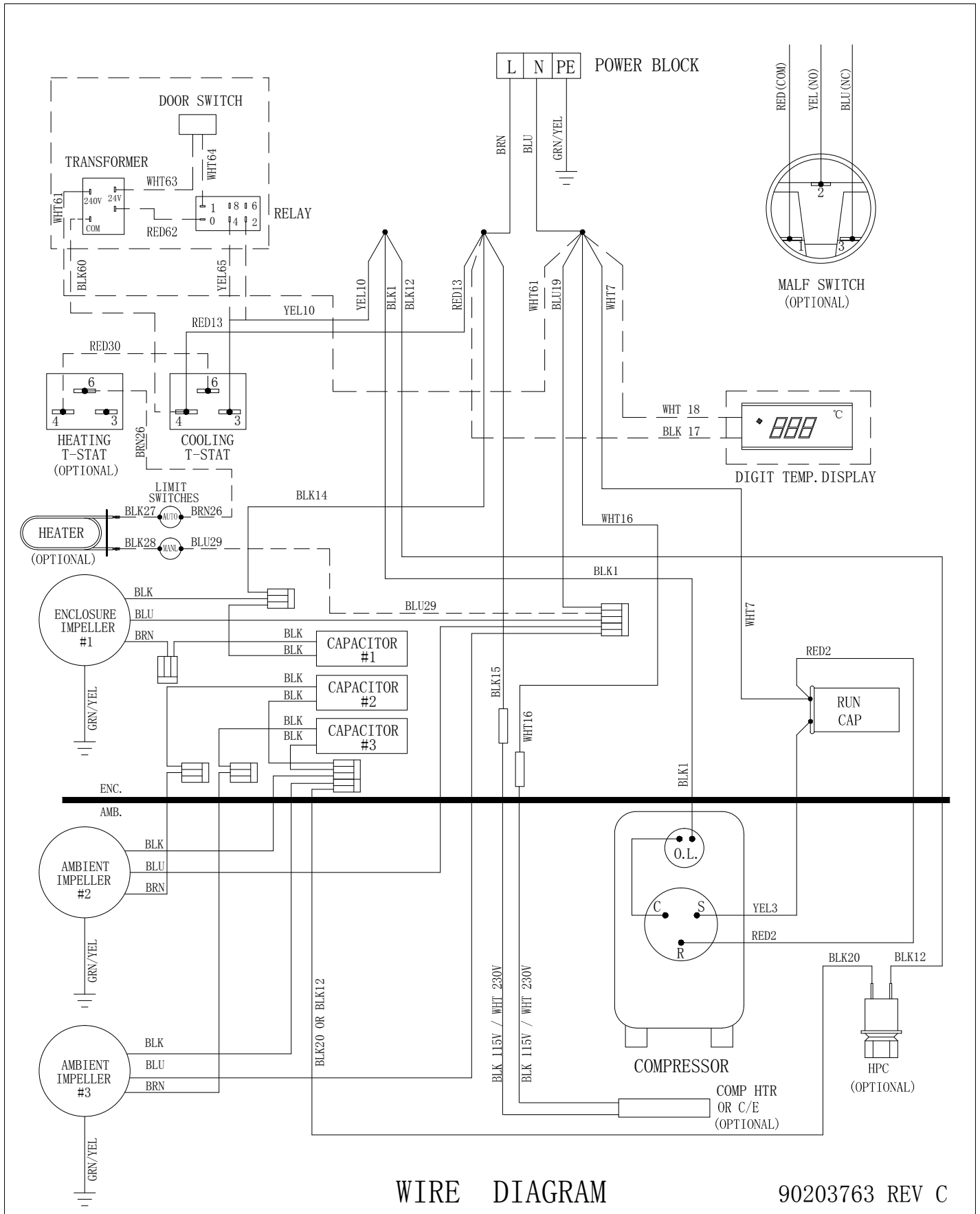

SCHEMATICS

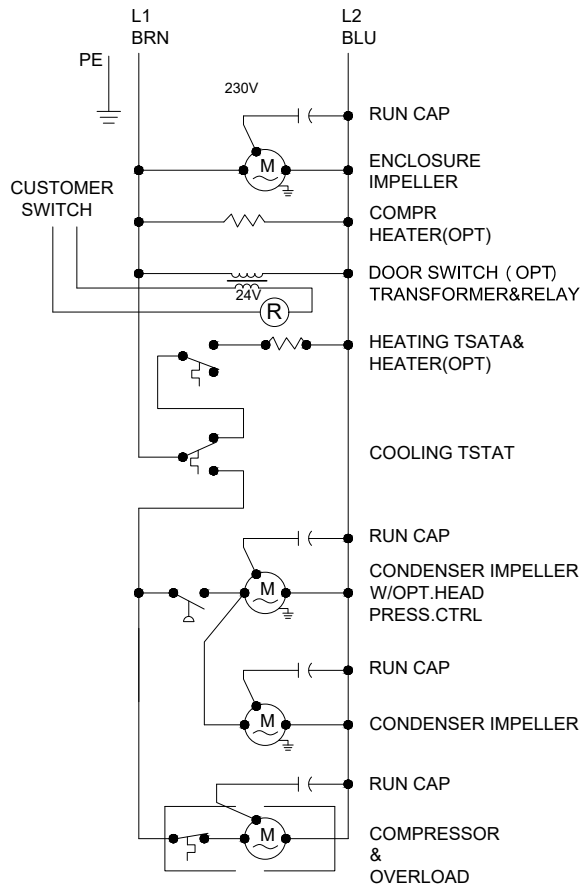

SERVICE DATA

COMPONENTS LIST

Part Description	Part Number	
	VA143025GXXXX	VA144025GXXXX
Capacitor, Compressor, Run	90233801	90391743
Capacitor, Condenser Impeller	3218246	3218246
Capacitor, Evaporator Impeller	3218246	3218288
Coil, Condenser	90203731	90203733
Coil, Evaporator	90203734	90203734
Compressor	89107889	90391742
Filter, Air, Reusable	90203767	3218252
Filter/Dryer	3208853	3208853
Head Pressure Control Switch (option)	90206992	90206992
Impeller, Condenser	3206049	3206049
Impeller, Evaporator	33206049	3218286
TXV	90256249	90256249
Thermostat, SPDT, 55-100F	3204580	3204580
Display(option)	90164848	90164848
T-Black 769-603/004/000	90164849	90164849
T-Black 769-103	90164850	90164850

MAINTENANCE COMPRESSOR

The compressor requires no maintenance. It is hermetically sealed, properly lubricated at the factory and should provide years of satisfactory operating service.

INLET AIR FILTER

Proper maintenance of the inlet air filter, located behind the front cover, will assure normal operation of the air conditioner. If filter maintenance is delayed or ignored, the maximum ambient temperatures under which the unit is designed to operate will be decreased.

If the compressor's operating temperature increases above designed conditions due to a dirty or clogged filter (or plugged condenser coil), the air conditioner's compressor will stop operating due to actuation of the thermal overload cut-out switch located on the compressor housing. As soon as the compressor temperature has dropped to within the switch's cut-in setting, the compressor will restart automatically. However the above condition will continue to take place until the filter or coil has been cleaned. It is recommended that power to the air conditioner be interrupted intentionally when abnormally high compressor operating temperature causes automatic shut-down of the unit. The above described shut-down is symptomatic of a clogged or dirty filter, thus causing a reduction in cooling air flow across the surface of the compressor and condenser coil.

Do not run the air conditioner for extended periods of time with the filter removed. Particles of dust, lint, etc., can plug the fins of the condenser coil which will give the same reaction as a plugged filter. The condenser coil is not visible through the filter opening, so protect it with a filter.

Continued operation under the above conditions can and will damage and shorten compressor life. The air conditioner is available with an easily removable inlet filter to facilitate necessary cleaning. There should be no reason to neglect this necessary maintenance.

HOW TO REMOVE, CLEAN OR INSTALL A NEW INLET AIR FILTER

RP aluminum washable air filters are designed to provide excellent filtering efficiency with a high dust holding capacity and a minimum amount of resistance to air flow. Because they are constructed entirely of aluminum they are lightweight and easy to service. To achieve maximum performance from your air handling equipment, air filters should be cleaned on a regular basis.

The inlet air filter is located behind the front cover. To access filter, pull ring protruding from slot in bottom of front cover. The filter may now be cleaned or new filter installed.

Cleaning Instructions:

1. Flush the filter with warm water from the exhaust side to the intake side. **DO NOT USE CAUSTICS.**
2. After flushing, allow filter to drain. Placing it with a corner down will assure complete drainage.

CONDENSER AND EVAPORATOR AIR MOVERS

Impeller motors require no maintenance. All bearings, shafts, etc. are lubricated during manufacturing for the life of the motor.

If the condenser impeller motor (ambient impeller) should fail, it is not necessary to remove the air conditioner from the cabinet or enclosure to replace the impeller. The condenser impeller is mounted on its own bulkhead and is easily accessible by removing the front cover.

CAUTION

Operation of the air conditioner in areas containing airborne caustics or chemicals can rapidly deteriorate filters, condenser coils, blowers and motors, etc. Contact Pentair Equipment Protection for special recommendations.

REFRIGERANT LOSS

Each air conditioner is thoroughly tested prior to leaving the factory to insure against refrigeration leaks. Shipping damage or microscopic leaks not found with sensitive electronic refrigerant leak detection equipment during manufacture may require repair or recharging of the system. This work should only be performed by qualified professionals, generally available through a local, reputable air conditioning repair or service company.

If the unit requires recharging, replace the charging tube with a new one, recommended size of charging copper tube is 6.35mm O.D. X 100mm L.

Refer to the data on the nameplate which specifies the type of refrigerant and the charge size in ounces.

Before recharging, make sure there are no leaks and that the system has been properly evacuated into a deep vacuum.

TROUBLE SHOOTING

BASIC AIR CONDITIONING TROUBLE SHOOTING CHECK LIST

1. Check manufacturer's nameplate located on the unit for correct power supply.
2. Turn on power to the unit. The evaporator (Enclosure or "COLD" air) fan should come on. Is there airflow?

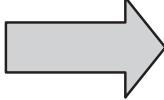
YES, proceed to step 3.
NO, possible problem:
<ul style="list-style-type: none">• Open motor winding• Stuck impeller motor• Obstructed wheel

Repair or Replace defective part

3. Check thermostat setting and adjust thermostat to the lowest setting. This should turn the condenser fan and the compressor on. Did condenser fan and compressor come on when the thermostat was turned on?

YES, proceed to step 4.
NO, possible problem:
<ul style="list-style-type: none">• Defective thermostat

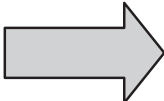
Replace Part

4. Are all impellers and the compressor running? If not the unit will not cool properly.
5. Check condenser (Ambient or "HOT" air) impellers for airflow. Is there airflow?

YES, proceed to step 6.
NO, possible problem:
<ul style="list-style-type: none">• Defective thermostat• Open motor winding• Stuck impeller motor• Obstructed wheel

Repair or Replace defective part

6. Carefully check the compressor for operation - motor should cause slight vibration, and the outer case of the compressor should be warm. Is the compressor showing signs of this?

YES, wait 5 minutes, then proceed to step 7.
NO, possible problem:
<ul style="list-style-type: none">• Defective thermostat• Open motor winding• Stuck impeller motor• Obstructed wheel

Repair or Replace defective part

7. Make sure the coils are clean. Then check evaporator "air in" and "air out" temperatures. If the temperatures are the same:

<ul style="list-style-type: none">• Possible loss of refrigerant• Possible bad valves in the compressor

Repair or Replace defective part

8. To check for a bad thermostat, turn power to the unit off. Remove the upper access panel and place both thermostat wires onto one terminal (replace upper access panel for safety). This will activate the switch in the thermostat. Turn the power on and if all impellers and the compressor come on, the thermostat needs to be replaced.

SYMPTOMS AND POSSIBLE CAUSES:

SYMPTOM	POSSIBLE CAUSE
Unit won't cool	Clogged fins on coil(s)
	Dirty filter
	Impellers not running
	Compressor not running
	Compressor runs, but has bad valves
	Loss of refrigerant
Compressor tries to start but won't run	Low line voltage at start. Should be +/-10% rated voltage.
	Compressor motor stuck
	Bad contactor
	Bad overload switch
Unit blows breakers	Undersized breaker/fuse or not time delayed
	Short in system
Getting water in enclosure	Drain plugged
	Drain tube kinked
	Enclosure not sealed (allowing humidity in)
	Mounting gasket damaged

For additional technical support, contact nVent Electrical Products China at 400-820-1133.



nVent Electrical Products China CO., Ltd.
No.39A, Xiangjiang 2nd Road,
Jimo District, Qingdao, Shandong, China.

 400-820-1133

 +86-532-87716106

nVent.com