

DESIGN^(PDU) ENGINEERING

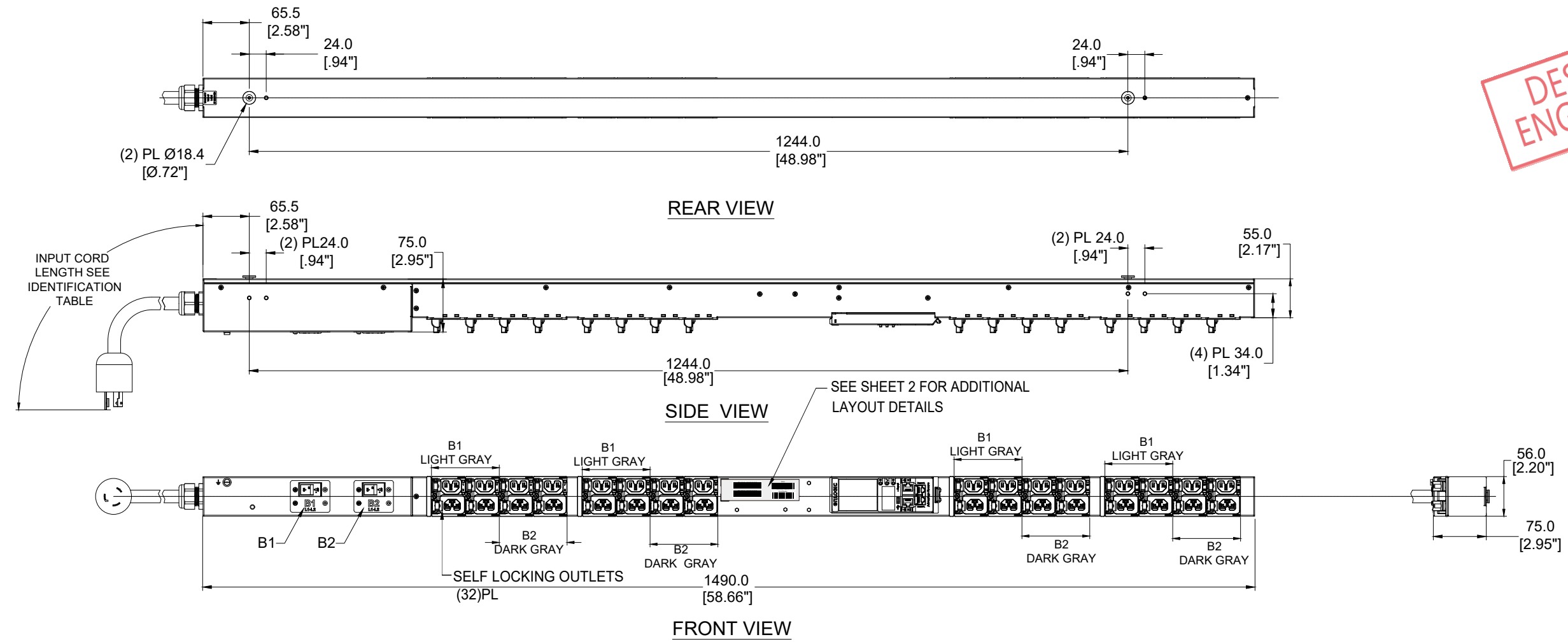

TECHNICAL SPECIFICATIONS	
UNIT TYPE:	MONITORED INPUT
ORIENTATION:	VERTICAL, 0U FULL
OUTLET QTY & TYPE:	(16)C13/C15 LOCKING,(16)C13/C15/C19 LOCKING
INPUT VOLTAGE:	200-240VAC
INPUT CURRENT:	30A(24A DERATED)
BREAKER QTY & TYPE:	(2) 20AMP, DOUBLE-POLE ,5KA
INPUT PHASE:	SINGLE-PHASE DELTA
RATED POWER:	5kVA
INPUT PLUG:	SEE NOTE 7
INPUT POWER CORD:	SEE IDENTIFICATION TABLE
FEATURES	
METERING ACCURACY	+/-1% TO ISO/ IEC 62052-21
METERING ATTRIBUTES	VOLTAGE(V), CURRENT(A), APPARENT POWER(kVA), REAL POWER(kW), POWER FACTOR, ENERGY(kWh)
METERED COMPONENTS	INPUT(PHASE), CIRCUIT BREAKERS
REMOTE OUTLET SWITCHING	N/A
ENVIRONMENTAL CONDITIONS	
OPERATING TEMPERATURE	-5 TO 60 C (23 TO 140 F)
STORAGE TEMPERATURE	-20 TO 60 C (-4 TO 140 F)
HUMIDITY (OPERATING/STORAGE)	5-90% RH / 5-95% RH; NON-CONDENSING
MAX OPERATING ELEVATION, ABOVE MSL	3000M(9840FT)
COMPLIANCE	
SAFETY&ENVIRONMENTAL	RoHS COMPLIANT

IDENTIFICATION TABLE	EN1381-*	* INPUT PLUG	* CHASSIS COLOR	* CORD OPTION	* ORIENTATION
MODEL IS SHOWN IN DEFAULT CONFIGURATION. FOR OPTIONAL CONFIGURATIONS, USE ITEM IDENTIFIER CODE IN PLACE OF EACH ASTERISK. ORDERABLE BASED ON FORMAT: EN1381-****		(DEFAULT) L6-30P=0	(DEFAULT) BLACK = 0 BLUE = B RED = R GREEN = G WHITE = W YELLOW = Y	(DEFAULT) 3m [10'] = 0 1m [3.2'] = 1 2m [6.6'] = 2 3m [10'] = 3	(DEFAULT) TOP FEED = 0 BOTTOM FEED = 2
OPTIONS LISTED ON THIS ROW ARE NON STANDARD, CONTACT SALES FOR ADDITIONAL INFORMATION			ORANGE = A	0.5m [1.6'] = A 1.2m [4'] = G 1.5m [4.9'] = B 1.8m [6'] = F 2.5m [8.2'] = C	

- NOTES :**
- INSTALLATION SHALL COMPLY WITH ALL APPLICABLE NATIONAL, STATE AND LOCAL CODES.
 - PRIMARY DIMENSIONS ARE IN MILLIMETERS. SECONDARY DIMENSIONS ARE IN [INCHES]
 - UNIVERSAL MOUNTING BRACKET IS AN ALTERNATIVE MOUNTING METHOD TO THE TOOLLESS MOUNT FOR 3RD PARTY ENCLOSURES. BRACKET IS PROVIDED WITH THE UNIT.
 - DETAILED INSTALLATION INSTRUCTIONS CAN BE FOUND IN THE QUICK START GUIDE
 - CONNECT EXTERNAL EARTH GROUND TO THE 10-32 SIZE THREADED NUT
 - SEE PRODUCT DOCUMENTATION FOR FURTHER INFORMATION
 - INPUT PLUG CONFIGURATION (SEE IDENTIFICATION TABLE) FOR DUAL-RATED UNITS, NEMA PLUGS ARE NAM RATED ONLY AND CAPTIVE AUS/NZ PLUGS ARE EMEA RATED ONLY

THIS DRAWING AND SPECIFICATIONS HEREIN ARE THE PROPERTY OF CIS GLOBAL AND SHALL NOT BE COPIED, REPRODUCED OR USED IN WHOLE OR IN PART, AS THE BASIS FOR THE MANUFACTURE OR SALE OF ITEMS WITHOUT WRITTEN PERMISSION FROM CIS GLOBAL. THIS DRAWING IS BASED UPON LATEST AVAILABLE INFORMATION AND IS SUBJECT TO CHANGE WITHOUT NOTICE

ECN/ECO	REV.	DESCRIPTION	DATE	APPROVED
E1		INITIAL DRAFT REVIEW	2023/04/11	LRF
REVISIONS				
TITLE :		UNLESS NOTED, DIMENSIONS ARE IN MILLIMETERS & TOLERANCES ARE:	PART NO: EN1381-WXYZ_DA	
PROJECT :		X ±1 MM	X° ±1°	REV. E1
		X.X ±0.5 MM	X.X° ±0.5°	DRAWN BY: LRF
		X ±0.20 MM		2023/04/11
		Ø X.X ±0.3 MM		ENGINEER: LJB
		Ø X.XX ±0.10 MM		2023/04/11
		BRACKETED DIMENSIONS ARE IN INCHES FOR REFERENCE ONLY		APPROVED BY: Hanson
		THIRD ANGLE PROJECTION		SCALE : N/A
		INTERPRET PER ASME Y14.5M-1994		SHEET 1 OF 3
				SIZE: A3

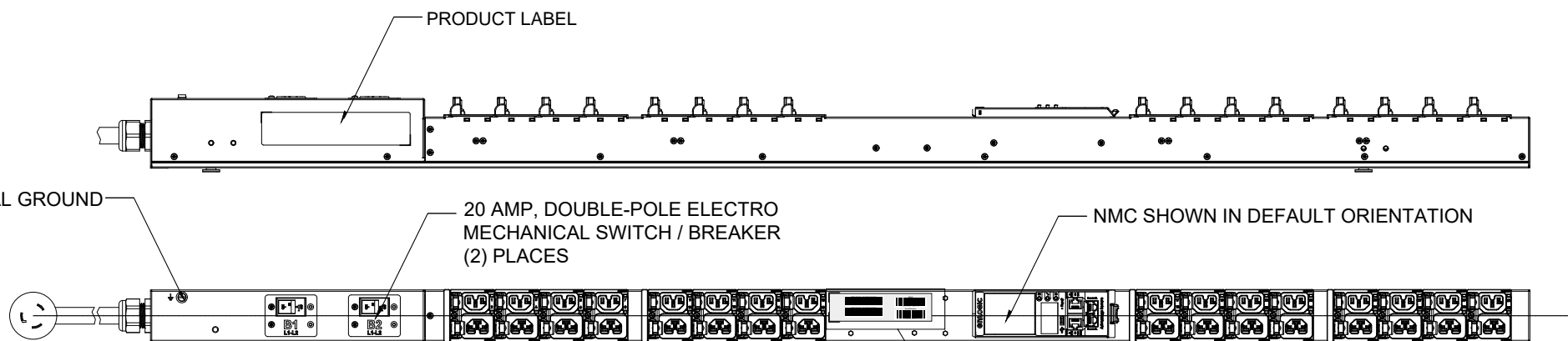

DESIGN^(PDU)
ENGINEERING

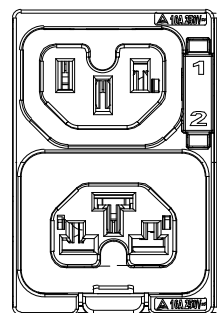
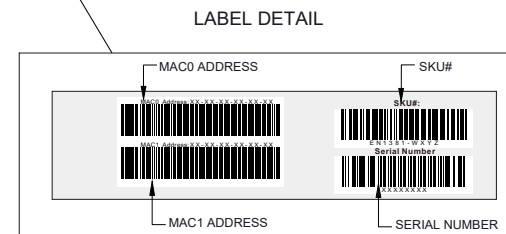

RECEPTACLE

C13/C15 COMBO
10A, 250V MAX
RATED OUTPUT

C13/C15/C19 COMBO
16A, 250V MAX
RATED OUTPUT

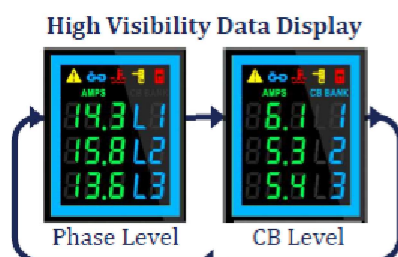
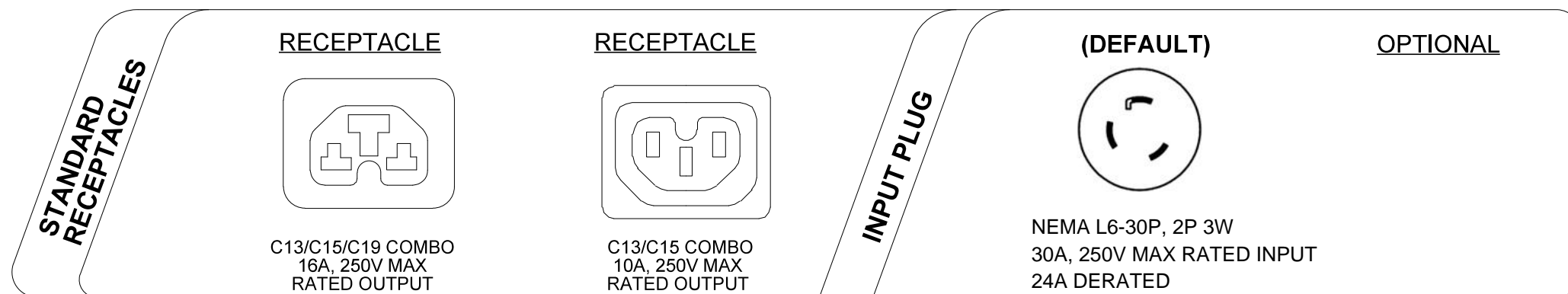

- Critical Alarm Alerts**
- PDU Alarm
 - Cascade Error
 - Environmental Alarm
 - Security Alarm
 - Circuit Breaker Alarm
- Source Color Coding (User Selected Option)**
-
- User Interactive Display (for setup and detailed information)**
- 10/100 Ethernet Port (for redundancy and Ethernet cascading)**
- Digital Sensor Port 2**

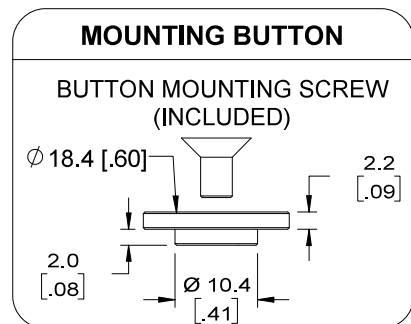

NOTES:
1. INSTALLATION SHALL COMPLY WITH ALL APPLICABLE NATIONAL, STATE AND LOCAL CODES.
2. SEE PRODUCT DOCUMENTATION FOR FURTHER INFORMATION

enLOGIC by nvent

THIS DRAWING AND SPECIFICATIONS HEREIN ARE THE PROPERTY OF CIS GLOBAL AND SHALL NOT BE COPIED, REPRODUCED OR USED IN WHOLE OR IN PART, AS THE BASIS FOR THE MANUFACTURE OR SALE OF ITEMS WITHOUT WRITTEN PERMISSION FROM CIS GLOBAL. THIS DRAWING IS BASED UPON LATEST AVAILABLE INFORMATION AND IS SUBJECT TO CHANGE WITHOUT NOTICE

TITLE:
Advantage Series
Metered

PROJECT:
enLOGIC

UNLESS NOTED, DIMENSIONS ARE IN MILLIMETERS & TOLERANCES ARE:
 X. ±1 MM X° ±1°
 X.X ±0.5 MM X.X° ±0.5°
 X.XX ±0.20 MM
 Ø X.X ±0.3 MM
 Ø X.XX ±0.10 MM

BRACKETED DIMENSIONS ARE IN INCHES FOR REFERENCE ONLY

⊕ THRID ANGLE PROJECTION
 INTERPRET PER ASME Y14.5M-1994

PART NO: EN1381-WXYZ_DA	REV. E1
DRAWN BY: LRF	2023/04/11
ENGINEER: LJB	2023/04/11
APPROVED BY: Hanson	2023/04/11
SCALE: N/A	SHEET: 2 OF 3
	SIZE: A3

enLOGIC RACK Power Distribution Unit **Metered** Made In XXXXX

SKU #: EN1381-WXYZ
 Model #: EP111024-0070-L
 INPUT: 200-240VAC, 1PHASE, 50/60Hz, 24A
 OUTPUT: C13/C15 LOCKING; 200-240VAC, 10A per outlet
 C13/C15/C19 LOCKING; 200-240VAC, 16A max per outlet
 24A Total

MAC0 Address:XX-XX-XX-XX-XX-XX
 MAC1 Address:XX-XX-XX-XX-XX-XX

FC SP US C 300805 50

SKU#: EN1381-WXYZ
 Serial Number: XXXXXX X X X X

THIS DEVICE COMPLIES WITH PART 15 OF THE FCC RULES. OPERATION IS SUBJECT TO THE FOLLOWING TWO CONDITIONS:
 (1) THIS DEVICE MAY NOT CAUSE HARMFUL INTERFERENCE AND (2) THIS DEVICE MUST ACCEPT ANY INTERFERENCE RECEIVED, INCLUDING INTERFERENCE THAT MAY CAUSE UNDESIRABLE OPERATION. CAN ICES-3(A)/NMB-3(A)

COMPLIANCE LABEL

NOTES:

1. INTERNAL WIRING

WIRE TYPE:

LINE 1/R/X COLOR:

LINE 2/S/Y COLOR:

EARTH GROUND COLOR: GREEN

2.FOR FINISHED GOOD PART NUMBER SEE IDENTIFICATION

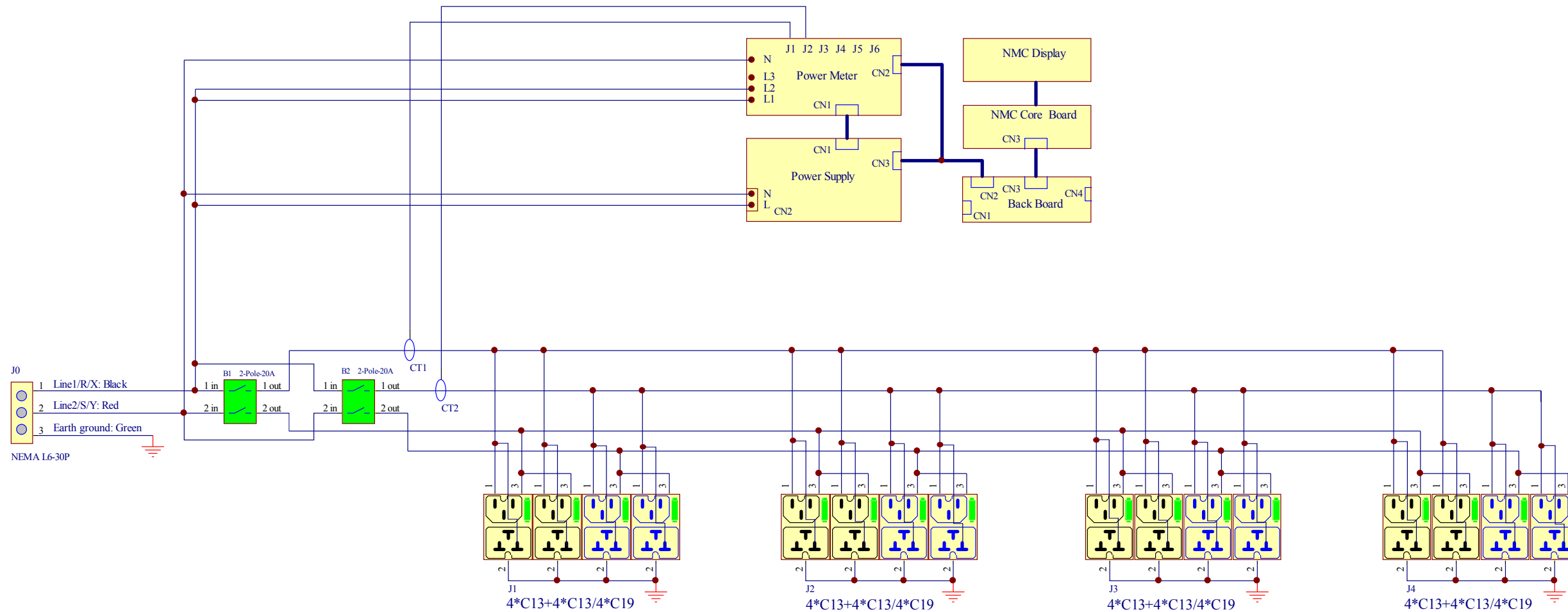

INTERNAL WIRING SCHEMATIC DIAGRAM

- NOTES:**
1. INSTALLATION SHALL COMPLY WITH ALL APPLICABLE NATIONAL, STATE AND LOCAL CODES.
 2. SEE PRODUCT DOCUMENTATION FOR FURTHER INFORMATION
 3. THIS DRAWING DEPICTS THE POWER SYSTEM CONNECTIONS AND IS NOT REPRESENTATIVE OF THE PHYSICAL LAYOUT. PLEASE REFER TO MECHANICAL DRAWINGS FOR PHYSICAL LAYOUT.

enLOGIC by nvent

THIS DRAWING AND SPECIFICATIONS HEREIN ARE THE PROPERTY OF CIS GLOBAL AND SHALL NOT BE COPIED, REPRODUCED OR USED IN WHOLE OR IN PART, AS THE BASIS FOR THE MANUFACTURE OR SALE OF ITEMS WITHOUT WRITTEN PERMISSION FROM CIS GLOBAL. THIS DRAWING IS BASED UPON LATEST AVAILABLE INFORMATION AND IS SUBJECT TO CHANGE WITHOUT NOTICE

TITLE:
 Advantage Series Metered

PROJECT:
 enLOGIC

UNLESS NOTED, DIMENSIONS ARE IN MILLIMETERS & TOLERANCES ARE:
 X. ±1 MM X° ±1°
 X.X ±0.5 MM X.X° ±0.5°
 X.XX ±0.20 MM
 ØX.X ±0.3 MM
 ØX.XX ±0.10 MM

BRACKETED DIMENSIONS ARE IN INCHES FOR REFERENCE ONLY
 THRID ANGLE PROJECTION
 INTERPRET PER ASME Y14.5M-1994

PART NO: EN1381-WXYZ_DA	REV. E1
DRAWN BY: LRF	2023/04/11
ENGINEER: LJB	2023/04/11
APPROVED BY: Hanson	2023/04/11
SCALE:N/A	SHEET 3 OF 3
	SIZE: A3