

**DESIGN<sup>(PDU)</sup> ENGINEERING**

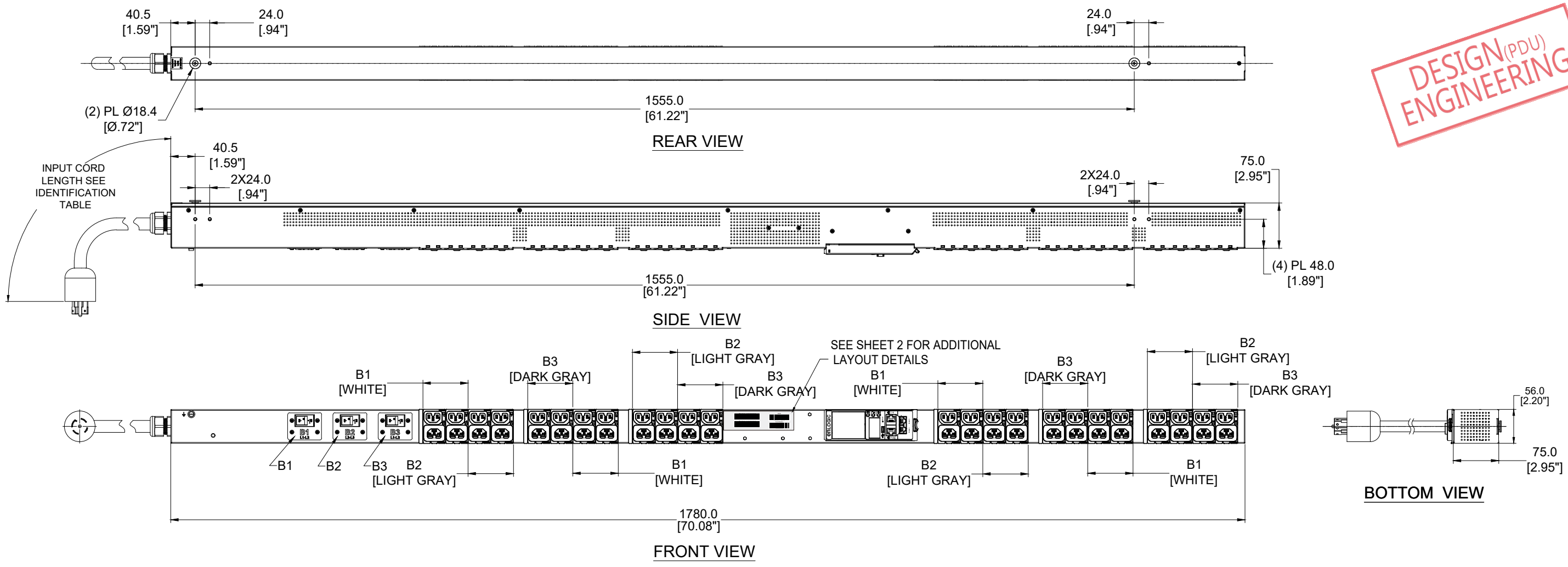

TECHNICAL SPECIFICATIONS	
UNIT TYPE:	MONITORED SWITCHED
ORIENTATION:	VERTICAL, 0U FULL
OUTLET QTY & TYPE:	(24)C13/C15, (24)C13/C15/C19
INPUT VOLTAGE:	208VAC
INPUT CURRENT:	30A (24A DERATED)
BREAKER QTY & TYPE:	(3) 20AMP, DOUBLE-POLE
INPUT PHASE:	THREE-PHASE, DELTA
RATED POWER:	8.6 kVA
INPUT PLUG:	SEE NOTE 7
INPUT POWER CORD:	SEE IDENTIFICATION TABLE
FEATURES	
METERING ACCURACY	+/-1% TO ISO/ IEC 62052-21
METERING ATTRIBUTES	VOLTAGE(V), CURRENT(A), APPARENT POWER(kVA), REAL POWER(kW), POWER FACTOR, ENERGY(kWh)
METERED COMPONENTS	INPUT(PHASE), CIRCUIT BREAKERS
REMOTE OUTLET SWITCHING	YES
ENVIRONMENTAL CONDITIONS	
OPERATING TEMPERATURE	-5 TO 60 C (23 TO 140 F)
STORAGE TEMPERATURE	-20 TO 60 C (-4 TO 140 F)
HUMIDITY (OPERATING/STORAGE)	5-90% RH / 5-95% RH; NON-CONDENSING
MAX OPERATING ELEVATION, ABOVE MSL	3000M(9840FT)
COMPLIANCE	
SAFETY&ENVIRONMENTAL	RoHS COMPLIANT

IDENTIFICATION TABLE	EN2851-*	* INPUT PLUG	* CHASSIS COLOR	* CORD OPTION	* ORIENTATION
MODEL IS SHOWN IN DEFAULT CONFIGURATION. FOR OPTIONAL CONFIGURATIONS, USE ITEM IDENTIFIER CODE IN PLACE OF EACH ASTERISK. ORDERABLE BASED ON FORMAT: EN2851-****		(DEFAULT) L21-30P=0	(DEFAULT) BLACK = 0 BLUE = B RED = R WHITE = W GREEN = G YELLOW = Y	(DEFAULT) 1.8m [6'] = 0 1m [3.2'] = 1 2m [6.6'] = 2 3m [10'] = 3	(DEFAULT) TOP FEED = 0 BOTTOM FEED = 2
OPTIONS LISTED ON THIS ROW ARE NON STANDARD, CONTACT SALES FOR ADDITIONAL INFORMATION		(OPTIONAL)15-30P=S	ORANGE = A	0.5m [1.6'] = A 1.5m [4.9'] = B 2.5m [8.2'] = C	

- NOTES :**
- INSTALLATION SHALL COMPLY WITH ALL APPLICABLE NATIONAL, STATE AND LOCAL CODES.
  - PRIMARY DIMENSIONS ARE IN MILLIMETERS. SECONDARY DIMENSIONS ARE IN [INCHES]
  - UNIVERSAL MOUNTING BRACKET IS AN ALTERNATIVE MOUNTING METHOD TO THE TOOLLESS MOUNT FOR 3RD PARTY ENCLOSURES. BRACKET IS PROVIDED WITH THE UNIT.
  - DETAILED INSTALLATION INSTRUCTIONS CAN BE FOUND IN THE QUICK START GUIDE
  - CONNECT EXTERNAL EARTH GROUND TO THE 10-32 SIZE THREADED NUT
  - SEE PRODUCT DOCUMENTATION FOR FURTHER INFORMATION
  - INPUT PLUG CONFIGURATION (SEE IDENTIFICATION TABLE) FOR DUAL-RATED UNITS, NEMA PLUGS ARE NAM RATED ONLY AND CAPTIVE AUS/NZ PLUGS ARE EMEA RATED ONLY

ECN/ECO	REV.	DESCRIPTION	DATE	APPROVED
ECN-2305-0101	E4	REVISE METER ACCURACY AND ATTRIBUTES CONTENT	2023/05/06	LRF
ECN-2302-0023	E3	ADD MAC LABEL	2023/02/09	LRF
CIS-PEC-2209-0042	E2	ADD AGENCY LABEL FOR L15	2022/09/05	Leo Liu
	E1	INITIAL DRAFT REVIEW	2022/05/24	LRF

**enLOGIC** by nvent

THIS DRAWING AND SPECIFICATIONS HEREIN ARE THE PROPERTY OF CIS GLOBAL AND SHALL NOT BE COPIED, REPRODUCED OR USED IN WHOLE OR IN PART, AS THE BASIS FOR THE MANUFACTURE OR SALE OF ITEMS WITHOUT WRITTEN PERMISSION FROM CIS GLOBAL. THIS DRAWING IS BASED UPON LATEST AVAILABLE INFORMATION AND IS SUBJECT TO CHANGE WITHOUT NOTICE

**TITLE :** Advantage Series Metered Switched

**PROJECT :** enLOGIC

UNLESS NOTED, DIMENSIONS ARE IN MILLIMETERS & TOLERANCES ARE:  
 X ±1 MM X° ±1°  
 X.X ±0.5 MM X.X° ±0.5°  
 X ±0.20 MM  
 Ø X.X ±0.3 MM  
 Ø X.XX ±0.10 MM

BRACKETED DIMENSIONS ARE IN INCHES FOR REFERENCE ONLY

⊕ THRID ANGLE PROJECTION  
 INTERPRET PER ASME Y14.5M-1994

**PART NO.:** EN2851-WXYZ\_DA  
**REV.:** E4

**DRAWN BY:** LRF  
**ENGINEER:** LJB  
**APPROVED BY:** Hanson

2022/05/24  
 2023/05/06  
 2023/05/06

SCALE : N/A

SHEET 1 OF 3  
 SIZE: A3

**DESIGN<sup>(PDU)</sup> ENGINEERING**

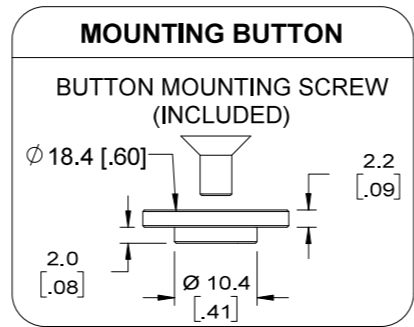
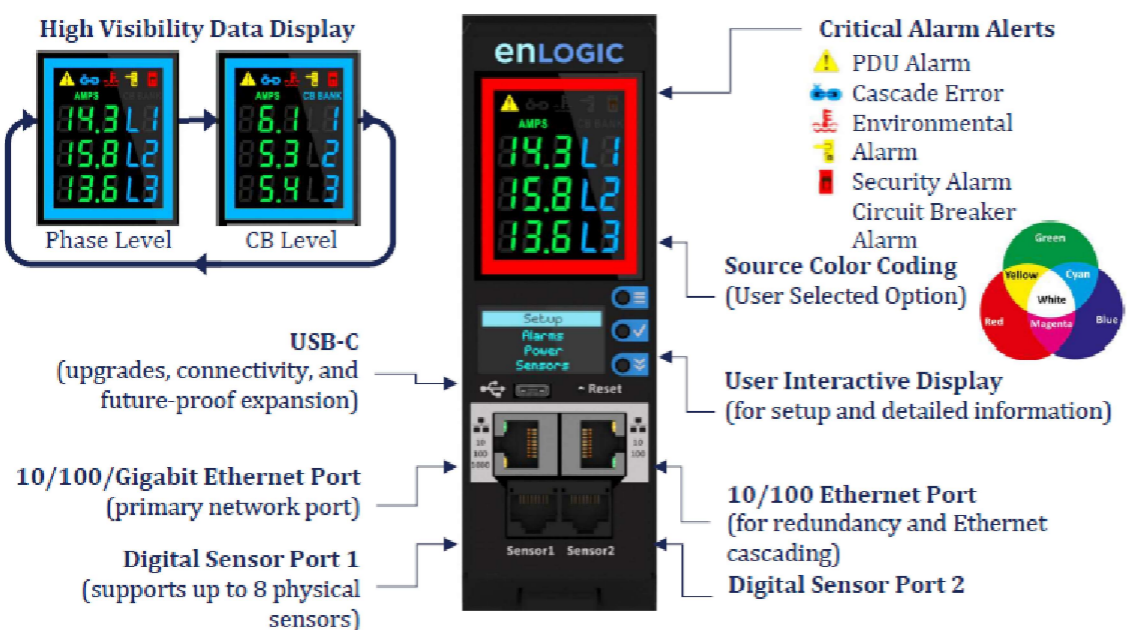
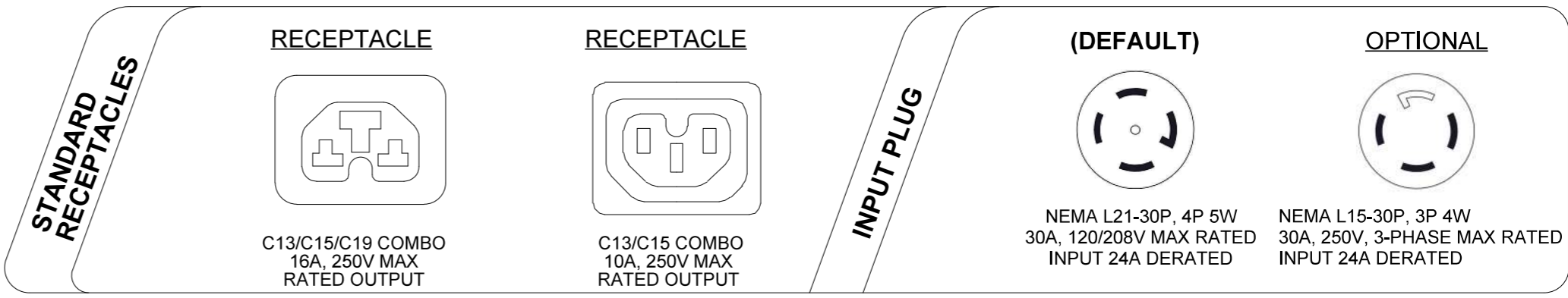
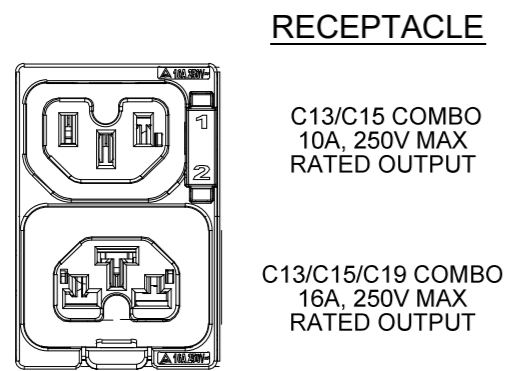
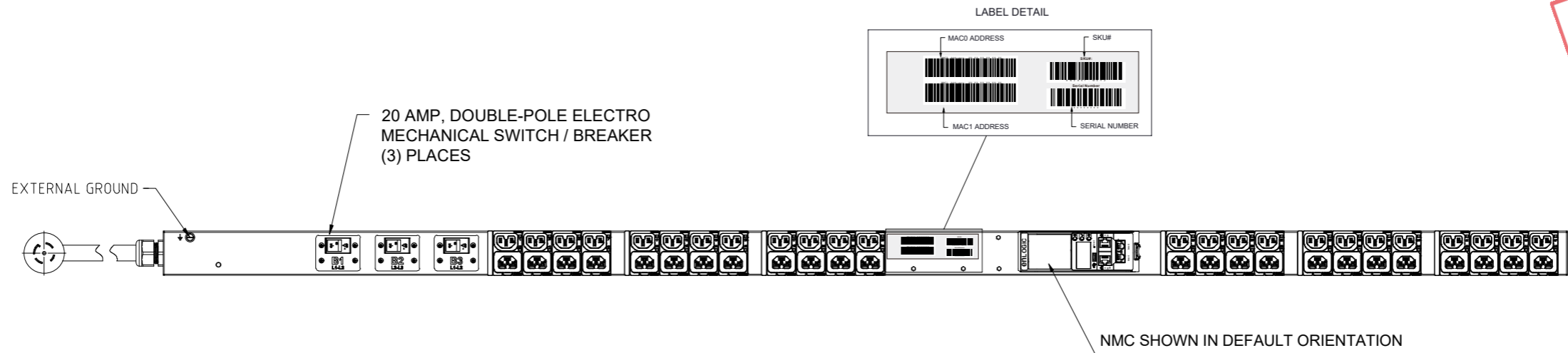

**NOTES:**

- INSTALLATION SHALL COMPLY WITH ALL APPLICABLE NATIONAL, STATE AND LOCAL CODES.
- SEE PRODUCT DOCUMENTATION FOR FURTHER INFORMATION

**enLOGIC by nvent**

THIS DRAWING AND SPECIFICATIONS HEREIN ARE THE PROPERTY OF CIS GLOBAL AND SHALL NOT BE COPIED, REPRODUCED OR USED IN WHOLE OR IN PART, AS THE BASIS FOR THE MANUFACTURE OR SALE OF ITEMS WITHOUT WRITTEN PERMISSION FROM CIS GLOBAL. THIS DRAWING IS BASED UPON LATEST AVAILABLE INFORMATION AND IS SUBJECT TO CHANGE WITHOUT NOTICE

**TITLE:** Advantage Series Metered Switched

**PROJECT:** enLOGIC

UNLESS NOTED, DIMENSIONS ARE IN MILLIMETERS & TOLERANCES ARE:

X. ±1 MM	X° ±1°
X.X ±0.5 MM	X.X° ±0.5°
X.XX ±0.20 MM	
Ø X.X ±0.3 MM	
Ø X.XX ±0.10 MM	

BRACKETED DIMENSIONS ARE IN INCHES FOR REFERENCE ONLY

⊕ THRID ANGLE PROJECTION

INTERPRET PER ASME Y14.5M-1994

<b>PART NO:</b> EN2851-WXYZ_DA	<b>REV:</b> E4
<b>DRAWN BY:</b> LRF	2022/05/24
<b>ENGINEER:</b> LJB	2023/05/06
<b>APPROVED BY:</b> Hanson	2023/05/06
<b>SCALE:</b> N/A	<b>SHEET:</b> 2 OF 3
	<b>SIZE:</b> A3

**enLOGIC** RACK Power Distribution Unit Metered Switched Made In XXXXX

SKU #: EN2851-WXYZ  
 Model #: EP126024-0062-C  
 INPUT: 100-120/200-240VAC, WYE, 3PHASE, 50/60Hz, 24A  
 OUTPUT: C13/C15 COMBO; 200-240VAC, 10A per outlet  
 C13/C15/C19 COMBO; 200-240VAC, 16A max per outlet  
 24A Total  
 MAC0 Address:XX-XX-XX-XX-XX  
 MAC1 Address:XX-XX-XX-XX-XX

FC, SP US 300805, 50

SKU#: EN2851-WXYZ  
 Serial Number: XXXXXXXX

THIS DEVICE COMPLIES WITH PART 15 OF THE FCC RULES. OPERATION IS SUBJECT TO THE FOLLOWING TWO CONDITIONS: (1) THIS DEVICE MAY NOT CAUSE HARMFUL INTERFERENCE, AND (2) THIS DEVICE MUST ACCEPT ANY INTERFERENCE RECEIVED, INCLUDING INTERFERENCE THAT MAY CAUSE UNDESIRABLE OPERATION. CAN ICES-3(A)/NMB-3(A)

Input Plug: L21-30P

**enLOGIC** RACK Power Distribution Unit Metered Switched Made In XXXXX

SKU #: EN2851-SXYZ  
 Model #: EP124024-0062-C  
 INPUT: 200-240VAC, DELTA, 3PHASE, 50/60Hz, 24A  
 OUTPUT: C13/C15 COMBO; 200-240VAC, 10A per outlet  
 C13/C15/C19 COMBO; 200-240VAC, 16A max per outlet  
 24A Total  
 MAC0 Address:XX-XX-XX-XX-XX  
 MAC1 Address:XX-XX-XX-XX-XX

FC, SP US 300805, 50

SKU#: EN2851-SXYZ  
 Serial Number: XXXXXXXX

THIS DEVICE COMPLIES WITH PART 15 OF THE FCC RULES. OPERATION IS SUBJECT TO THE FOLLOWING TWO CONDITIONS: (1) THIS DEVICE MAY NOT CAUSE HARMFUL INTERFERENCE, AND (2) THIS DEVICE MUST ACCEPT ANY INTERFERENCE RECEIVED, INCLUDING INTERFERENCE THAT MAY CAUSE UNDESIRABLE OPERATION. CAN ICES-3(A)/NMB-3(A)

Input Plug: L15-30P

**DESIGN (PDU) ENGINEERING**

- NOTES:
- 1. INTERNAL WIRING WIRE TYPE: UL AWM 1015, 12 & 18 AWG
  - LINE 1/R/X COLOR: Black
  - LINE 2/S/Y COLOR: Orange
  - LINE 3/T/Z COLOR: Red
  - NEUTRAL COLOR: White (NA)
  - EARTH GROUND COLOR: Green
  - 2. FOR FINISHED GOOD PART NUMBER SEE IDENTIFICATION

COMPLIANCE LABEL

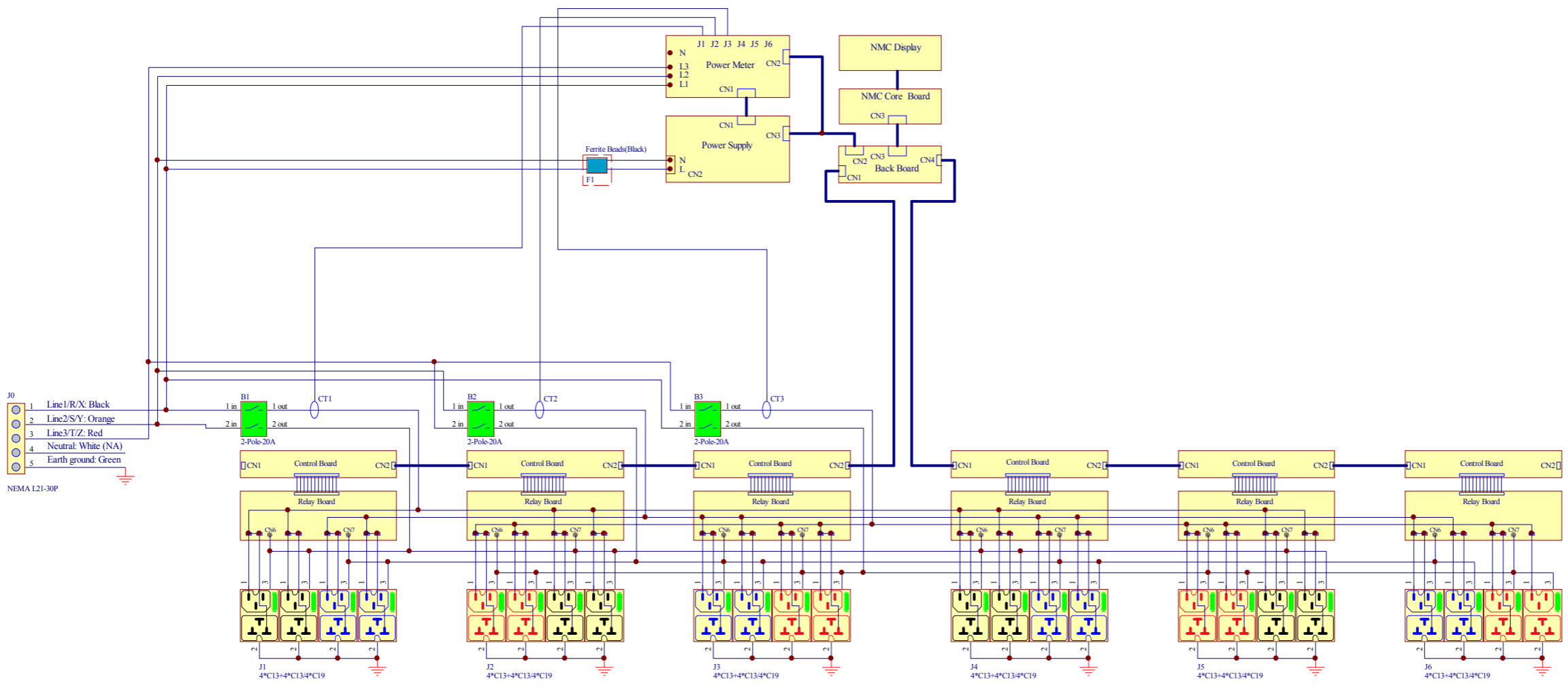

INTERNAL WIRING SCHEMATIC DIAGRAM

- NOTES:
1. INSTALLATION SHALL COMPLY WITH ALL APPLICABLE NATIONAL, STATE AND LOCAL CODES.
  2. SEE PRODUCT DOCUMENTATION FOR FURTHER INFORMATION
  3. THIS DRAWING DEPICTS THE POWER SYSTEM CONNECTIONS AND IS NOT REPRESENTATIVE OF THE PHYSICAL LAYOUT. PLEASE REFER TO MECHANICAL DRAWINGS FOR PHYSICAL LAYOUT.

**enLOGIC** by nvent

THIS DRAWING AND SPECIFICATIONS HEREIN ARE THE PROPERTY OF CIS GLOBAL AND SHALL NOT BE COPIED, REPRODUCED OR USED IN WHOLE OR IN PART, AS THE BASIS FOR THE MANUFACTURE OR SALE OF ITEMS WITHOUT WRITTEN PERMISSION FROM CIS GLOBAL. THIS DRAWING IS BASED UPON LATEST AVAILABLE INFORMATION AND IS SUBJECT TO CHANGE WITHOUT NOTICE

TITLE: Advantage Series Metered Switched

PROJECT: enLOGIC

UNLESS NOTED, DIMENSIONS ARE IN MILLIMETERS & TOLERANCES ARE:

X, ±1 MM	X° ±1°
X.X ±0.5 MM	X.X° ±0.5°
X.XX ±0.20 MM	
∅X.X ±0.3 MM	
∅X.XX ±0.10 MM	

BRACKETED DIMENSIONS ARE IN INCHES FOR REFERENCE ONLY

⊕ THRID ANGLE PROJECTION

INTERPRET PER ASME Y14.5M-1994

PART NO:	EN2851-WXYZ_DA	REV.	E4
DRAWN BY:	LRF		2022/05/24
ENGINEER:	LJB		2023/05/06
APPROVED BY:	Hanson		2023/05/06
SCALE:	N/A	SHEET	3 OF 3
		SIZE:	A3