

**DESIGN<sup>(PDU)</sup> ENGINEERING**

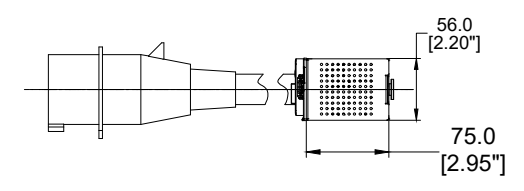
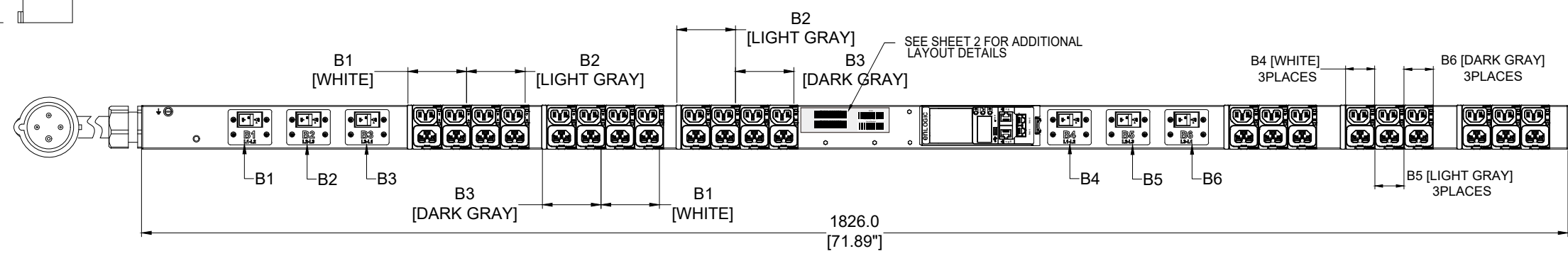
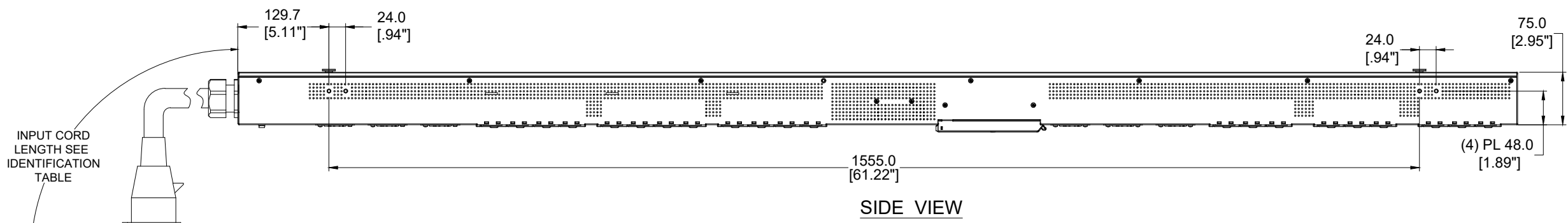
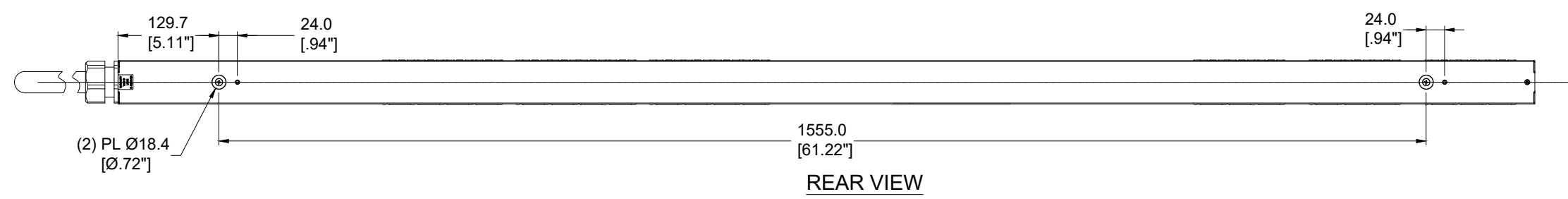

TECHNICAL SPECIFICATIONS	
UNIT TYPE:	MONITORED SWITCHED
ORIENTATION:	VERTICAL, 0U FULL
OUTLET QTY & TYPE:	(21)C13/C15,(21)C13/C15/C19
INPUT VOLTAGE:	208VAC
INPUT CURRENT:	60A (48A DERATED)
BREAKER QTY & TYPE:	(6)20AMP, DOUBLE-POLE
INPUT PHASE:	THREE-PHASE, DELTA
RATED POWER:	17.3 kVA
INPUT PLUG:	SEE NOTE 7
INPUT POWER CORD:	SEE IDENTIFICATION TABLE
FEATURES	
METERING ACCURACY	+/-1% TO ISO/ IEC 62052-21
METERING ATTRIBUTES	VOLTAGE(V), CURRENT(A), APPARENT POWER(kVA), REAL POWER(kW), POWER FACTOR, ENERGY(kWh)
METERED COMPONENTS	INPUT(PHASE), CIRCUIT BREAKERS
REMOTE OUTLET SWITCHING	YES
ENVIRONMENTAL CONDITIONS	
OPERATING TEMPERATURE	-5 TO 60 C (23 TO 140 F)
STORAGE TEMPERATURE	-20 TO 60 C (-4 TO 140 F)
HUMIDITY (OPERATING/STORAGE)	5-90% RH / 5-95% RH; NON-CONDENSING
MAX OPERATING ELEVATION, ABOVE MSL	3000M(9840FT)
COMPLIANCE	
SAFETY&ENVIRONMENTAL	RoHS COMPLIANT

IDENTIFICATION TABLE	EN2952-*	INPUT PLUG*	CHASSIS COLOR*	CORD OPTION*	ORIENTATION*
MODEL IS SHOWN IN DEFAULT CONFIGURATION. FOR OPTIONAL CONFIGURATIONS, USE ITEM IDENTIFIER CODE IN PLACE OF EACH ASTERISK. ORDERABLE BASED ON FORMAT: EN2952-****		(DEFAULT) 460P9 (IP44) = 0	(DEFAULT) BLACK = 0 BLUE = B RED = R WHITE = W GREEN = G YELLOW = Y	(DEFAULT) 1.8m [6'] = 0 1m [3.2'] = 1 2m [6.6'] = 2 3m [10'] = 3	(DEFAULT) TOP FEED = 0 BOTTOM FEED = 2
OPTIONS LISTED ON THIS ROW ARE NON STANDARD, CONTACT SALES FOR ADDITIONAL INFORMATION		(OPTIONAL) 460P9 W(IP67) = Z	ORANGE = A	0.5m [1.6'] = A 1.5m [4.9'] = B 2.5m [8.2'] = C	

- NOTES :
- INSTALLATION SHALL COMPLY WITH ALL APPLICABLE NATIONAL, STATE AND LOCAL CODES.
  - PRIMARY DIMENSIONS ARE IN MILLIMETERS. SECONDARY DIMENSIONS ARE IN [INCHES]
  - UNIVERSAL MOUNTING BRACKET IS AN ALTERNATIVE MOUNTING METHOD TO THE TOOLLESS MOUNT FOR 3RD PARTY ENCLOSURES. BRACKET IS PROVIDED WITH THE UNIT.
  - DETAILED INSTALLATION INSTRUCTIONS CAN BE FOUND IN THE QUICK START GUIDE
  - CONNECT EXTERNAL EARTH GROUND TO THE 10-32 SIZE THREADED NUT
  - SEE PRODUCT DOCUMENTATION FOR FURTHER INFORMATION
  - INPUT PLUG CONFIGURATION (SEE IDENTIFICATION TABLE) FOR DUAL-RATED UNITS, NEMA PLUGS ARE NAM RATED ONLY AND CAPTIVE AUS/NZ PLUGS ARE EMEA RATED ONLY

**enLOGIC** by nVent

THIS DRAWING AND SPECIFICATIONS HEREIN ARE THE PROPERTY OF CIS GLOBAL AND SHALL NOT BE COPIED, REPRODUCED OR USED IN WHOLE OR IN PART, AS THE BASIS FOR THE MANUFACTURE OR SALE OF ITEMS WITHOUT WRITTEN PERMISSION FROM CIS GLOBAL. THIS DRAWING IS BASED UPON LATEST AVAILABLE INFORMATION AND IS SUBJECT TO CHANGE WITHOUT NOTICE

ECN/ECO	REV.	DESCRIPTION	DATE	APPROVED
ECN-2302-0023	E3	ADD MAC LABEL	2023/02/09	LRF
ECN-2210-0226	E2	REVISE METER ACCURACY AND ATTRIBUTES CONTENT	2022/10/08	Leo Liu
	E1	INITIAL DRAFT REVIEW	2022/05/24	LRF

**REVISIONS**

TITLE : Advantage Series Metered Switched

PROJECT : enLOGIC

UNLESS NOTED, DIMENSIONS ARE IN MILLIMETERS & TOLERANCES ARE:  
 X ±1 MM X° ±1°  
 X.X ±0.5 MM X.X° ±0.5°  
 X ±0.20 MM  
 Ø X.X ±0.3 MM  
 Ø X.XX ±0.10 MM

BRACKETED DIMENSIONS ARE IN INCHES FOR REFERENCE ONLY

⊕ THRID ANGLE PROJECTION  
 INTERPRET PER ASME Y14.5M-1994

PART NO: EN2952-WXYZ\_DA REV. E3  
 DRAWN BY: LRF 2022/05/24  
 ENGINEER: LJB 2023/02/09  
 APPROVED BY: Hanson 2023/02/09

SCALE : N/A SHEET 1 OF 3 SIZE: A3

**DESIGN<sup>(PDU)</sup>  
ENGINEERING**

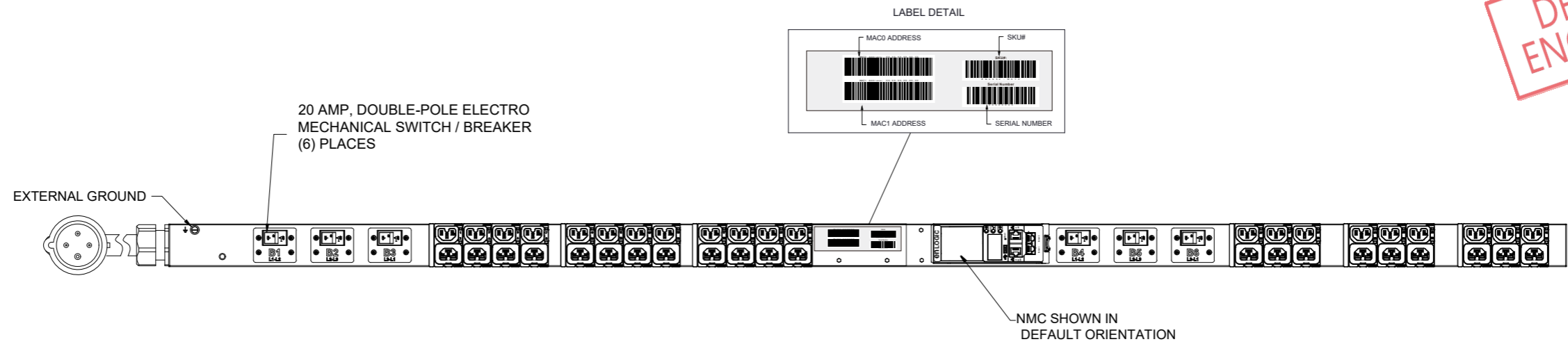

**RECEPTACLE**

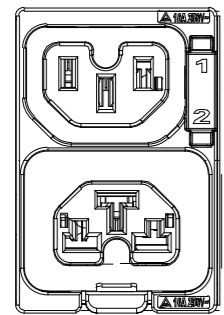

C13/C15 COMBO  
10A, 250V MAX  
RATED OUTPUT

C13/C15/C19 COMBO  
16A, 250V MAX  
RATED OUTPUT

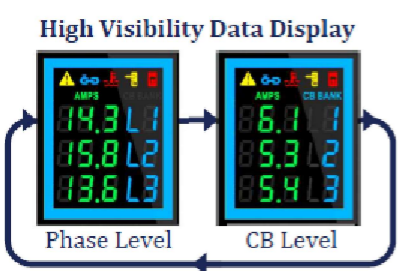
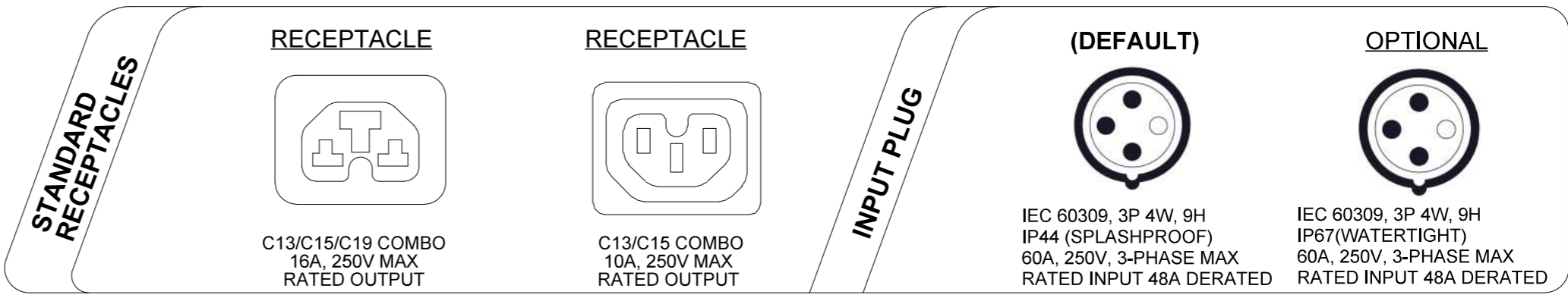

- Critical Alarm Alerts**
- ⚠ PDU Alarm
  - 🔗 Cascade Error
  - 🌡 Environmental Alarm
  - 🔒 Security Alarm
  - 🔧 Circuit Breaker Alarm
- Source Color Coding (User Selected Option)**
- 
- User Interactive Display (for setup and detailed information)**
- 10/100 Ethernet Port (for redundancy and Ethernet cascading)**
- Digital Sensor Port 2**

- High Visibility Data Display**
- Phase Level      CB Level
- USB-C**  
(upgrades, connectivity, and future-proof expansion)
- 10/100/Gigabit Ethernet Port**  
(primary network port)
- Digital Sensor Port 1**  
(supports up to 8 physical sensors)

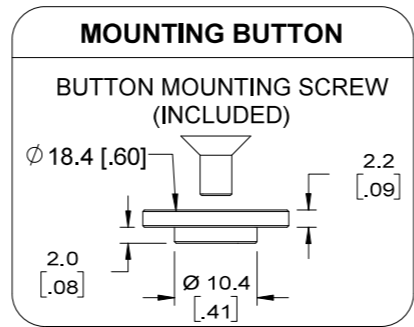

**NOTES:**

- INSTALLATION SHALL COMPLY WITH ALL APPLICABLE NATIONAL, STATE AND LOCAL CODES.
- SEE PRODUCT DOCUMENTATION FOR FURTHER INFORMATION

**enLOGIC by nvent**

THIS DRAWING AND SPECIFICATIONS HEREIN ARE THE PROPERTY OF CIS GLOBAL AND SHALL NOT BE COPIED, REPRODUCED OR USED IN WHOLE OR IN PART, AS THE BASIS FOR THE MANUFACTURE OR SALE OF ITEMS WITHOUT WRITTEN PERMISSION FROM CIS GLOBAL. THIS DRAWING IS BASED UPON LATEST AVAILABLE INFORMATION AND IS SUBJECT TO CHANGE WITHOUT NOTICE

**TITLE:**  
Advantage Series  
Metered Switched

**PROJECT**  
**enLOGIC**

UNLESS NOTED, DIMENSIONS ARE IN MILLIMETERS & TOLERANCES ARE:

X. ±1 MM	X° ±1°
X.X ±0.5 MM	X.X° ±0.5°
X.XX ±0.20 MM	
Ø X.X ±0.3 MM	
Ø X.XX ±0.10 MM	

BRACKETED DIMENSIONS ARE IN INCHES FOR REFERENCE ONLY

⊕ THRID ANGLE PROJECTION  
INTERPRET PER ASME Y14.5M-1994

<b>PART NO:</b> EN2952-WXYZ_DA	<b>REV.</b> E3
<b>DRAWN BY:</b> LRF	2022/05/24
<b>ENGINEER:</b> LJB	2023/02/09
<b>APPROVED BY:</b> Hanson	2023/02/09
<b>SCALE:</b> N/A	<b>SHEET</b> 2 OF 3
	<b>SIZE:</b> A3

**enLOGIC** RACK Power Distribution Unit Metered Switched Made In XXXXX

SKU #: EN2952-WXYZ  
 Model #: EP124048-0061-C  
 INPUT: 200-240VAC, DELTA, 3PHASE, 50/60Hz, 48A  
 OUTPUT: C13/C15 COMBO; 200-240VAC, 10A per outlet  
 C13/C15/C19 COMBO; 200-240VAC, 16A max per outlet  
 48A Total

MAC0 Address:XX-XX-XX-XX-XX  
 MAC1 Address:XX-XX-XX-XX-XX

FC C 300805 US  
 THIS DEVICE COMPLIES WITH PART 15 OF THE FCC RULES. OPERATION IS SUBJECT TO THE FOLLOWING TWO CONDITIONS: (1) THIS DEVICE MAY NOT CAUSE HARMFUL INTERFERENCE. AND (2) THIS DEVICE MUST ACCEPT ANY INTERFERENCE RECEIVED, INCLUDING INTERFERENCE THAT MAY CAUSE UNDESIRABLE OPERATION. CAN ICES-3(A)/NMB-3(A)

SKU#: EN2952-WXYZ  
 Serial Number: XXXXXX X X X X

COMPLIANCE LABEL

NOTES:

1. INTERNAL WIRING

WIRE TYPE:

UL AWM 1015,10 & 12 & 18 AWG

LINE 1/R/X COLOR: Black

LINE 2/S/Y COLOR: Orange

LINE 3/T/Z COLOR: Red

EARTH GROUND COLOR: Green/Yellow

2. FOR FINISHED GOOD PART NUMBER SEE IDENTIFICATION

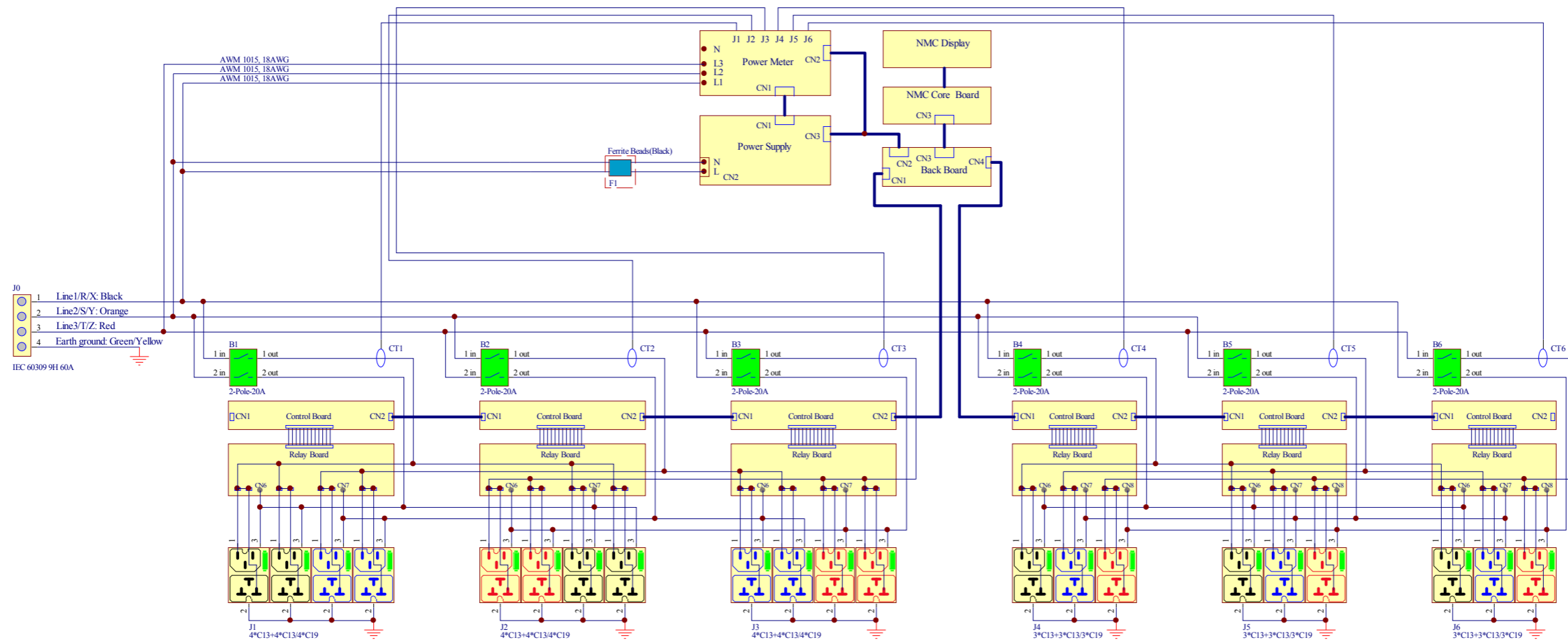
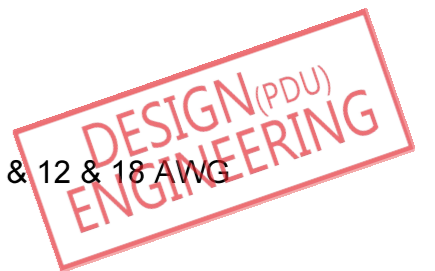

INTERNAL WIRING SCHEMATIC DIAGRAM

NOTES:

1. INSTALLATION SHALL COMPLY WITH ALL APPLICABLE NATIONAL, STATE AND LOCAL CODES.
2. SEE PRODUCT DOCUMENTATION FOR FURTHER INFORMATION
3. THIS DRAWING DEPICTS THE POWER SYSTEM CONNECTIONS AND IS NOT REPRESENTATIVE OF THE PHYSICAL LAYOUT. PLEASE REFER TO MECHANICAL DRAWINGS FOR PHYSICAL LAYOUT.



THIS DRAWING AND SPECIFICATIONS HEREIN ARE THE PROPERTY OF CIS GLOBAL AND SHALL NOT BE COPIED, REPRODUCED OR USED IN WHOLE OR IN PART, AS THE BASIS FOR THE MANUFACTURE OR SALE OF ITEMS WITHOUT WRITTEN PERMISSION FROM CIS GLOBAL. THIS DRAWING IS BASED UPON LATEST AVAILABLE INFORMATION AND IS SUBJECT TO CHANGE WITHOUT NOTICE

TITLE:

Advantage Series Metered Switched

PROJECT:

enLOGIC

UNLESS NOTED, DIMENSIONS ARE IN MILLIMETERS & TOLERANCES ARE:

X. ±1 MM	X° ±1°
X.X ±0.5 MM	X.X° ±0.5°
X.XX ±0.20 MM	
∅X.X ±0.3 MM	
∅X.XX ±0.10 MM	

BRACKETED DIMENSIONS ARE IN INCHES FOR REFERENCE ONLY

⊕ THRID ANGLE PROJECTION

INTERPRET PER ASME Y14.5M-1994

PART NO: EN2952-WXYZ\_DA

DRAWN BY: LRF

ENGINEER: LJB

APPROVED BY: Hanson

SCALE: N/A

REV. E3

2022/05/24

2023/02/09

2023/02/09

SHEET 3 OF 3

SIZE: A3