

客户信息/Customer info.		ECN 编号	图号	数量	版本	签名	日期
版本/REV.	图号/PN	ECN No.	Drawing mark	Places	REV.	Sign	Date
--	--	--	--	--	E1	Luo Jinbo	20200420

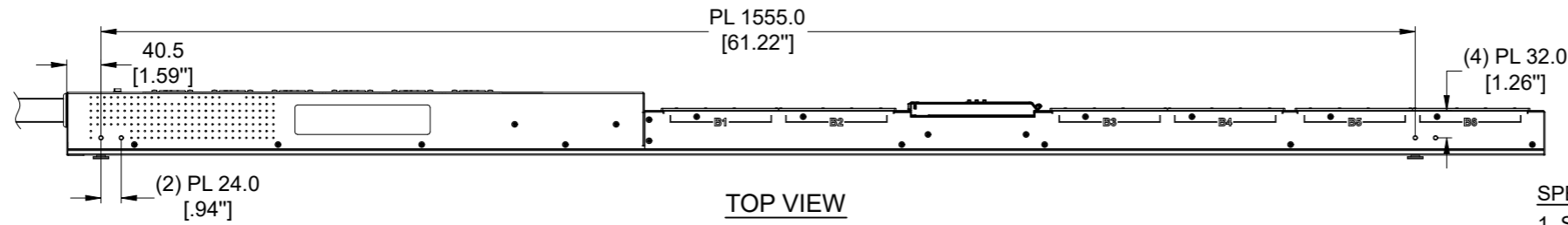

TOP VIEW

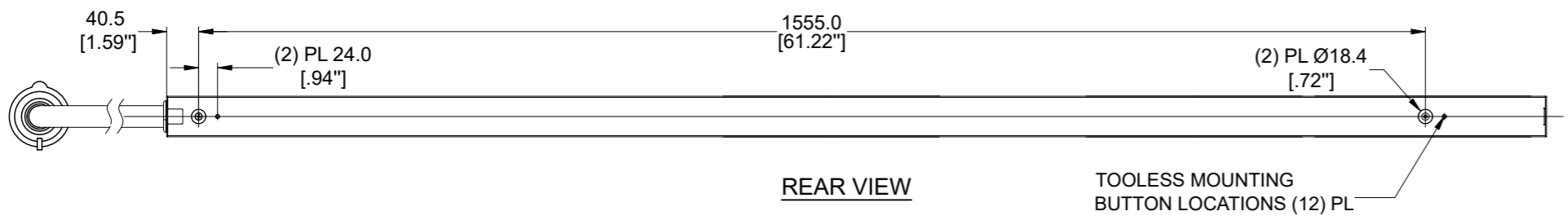

REAR VIEW

TOOLESS MOUNTING  
BUTTON LOCATIONS (12) PL

SPECIFICATION:

1. STANDARD:

UNIT TYPE:	MONITORED & SWITCHED PER OUTLET
ORIENTATION:	VERTICAL, 0U FULL
OUTLET QTY&TYPE:	(12) C13, (12) C19
INPUT VOLTAGE:	200-240VAC
INPUT CURRENT:	60A (48A DERATED)
BREAKER QTY&TYPE:	(6) 20AMP, DOUBLE-POLE
INPUT PHASE:	THREE-PHASE DELTA
RATED POWER:	17.3kVA
INPUT PLUG:	IEC 60309 3P+E 9H 60A
INPUT POWER CORD:	3m[10], TOP FEED
REGULATORY STANDARD:	RoHS COMPLIANT

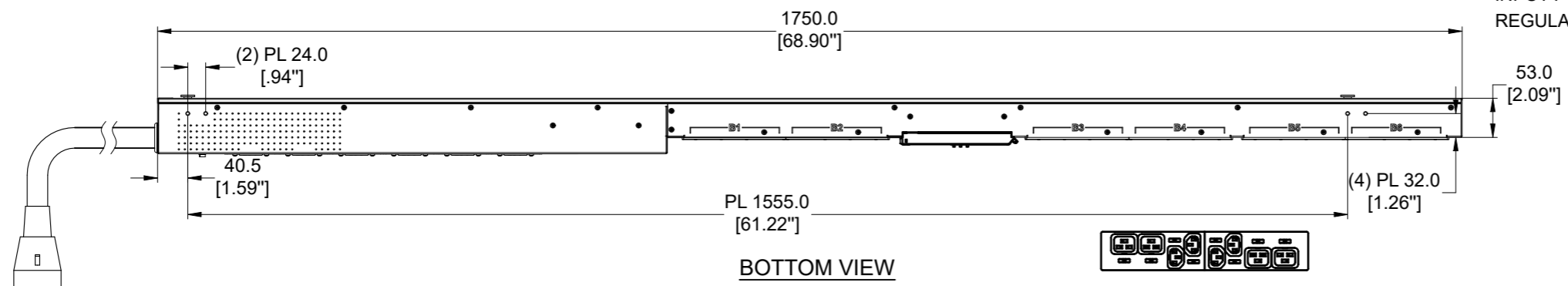

BOTTOM VIEW

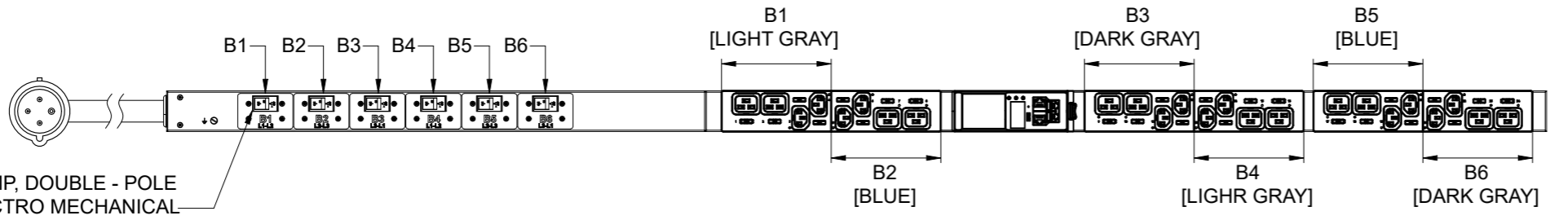

FRONT VIEW

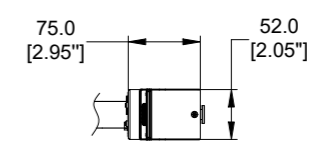

RIGHT VIEW

PLUG/RECEPTACLE BLOCK



PLUG  
IEC 60309, 3P 4W, 9H  
IP44 (SPLASHPROOF)  
60A, 250V, 3-PHASE MAX RATED INPUT  
48A DERATED

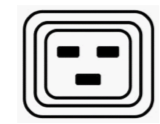

RECEPTACLES  
IEC 60320/C19  
16A, 250V MAX RATED OUTPUT

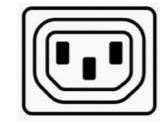

RECEPTACLES  
IEC 60320/C13  
10A, 250V MAX RATED OUTPUT

**CISGLOBAL**

项目 EN2.0				阶段标记	
Project				S	
图号 TA-EN6902A				PN	
名称 PDU				Weight N/A	
Title				Scale 1:3	
材料 Assembly				Size A2	
Material				Page 1 of 1	
设计/Design	Jingbo Luo	日期/Date	2020.05.20	名称	PDU
审核/Check	Aric Wang	日期/Date	2020.05.20	Title	
工艺检查/Review	Talon LV	日期/Date	2020.05.20	材料	Assembly
批准/Approve	Hanson Xu	日期/Date	2020.05.20	Material	