



CONNECT AND PROTECT

Global IEC Product Portfolio



HOFFMAN

Table of contents

Floor Standing Enclosures	8
Modular, single door MCS.....	10
Modular, double door MCD.....	14
Modular, single door MCS-HP	18
Flange Mount Disconnect MCF.....	22
Modular, single door MCSS.....	26
Modular, double door MCDS	30
Modular, single door MCSS-HP.....	34
Floor Standing - Accessories	38
Wall Mounted Enclosures	108
Single door MAS	110
Double door MAD	116
Single door ASR	120
Double door ADR	124
Wall Mounted - Accessories.....	128
Terminal Boxes.....	146
Mild steel terminal box STB.....	146
Stainless steel terminal box SSTB	148
Terminal Boxes - Accessories.....	150

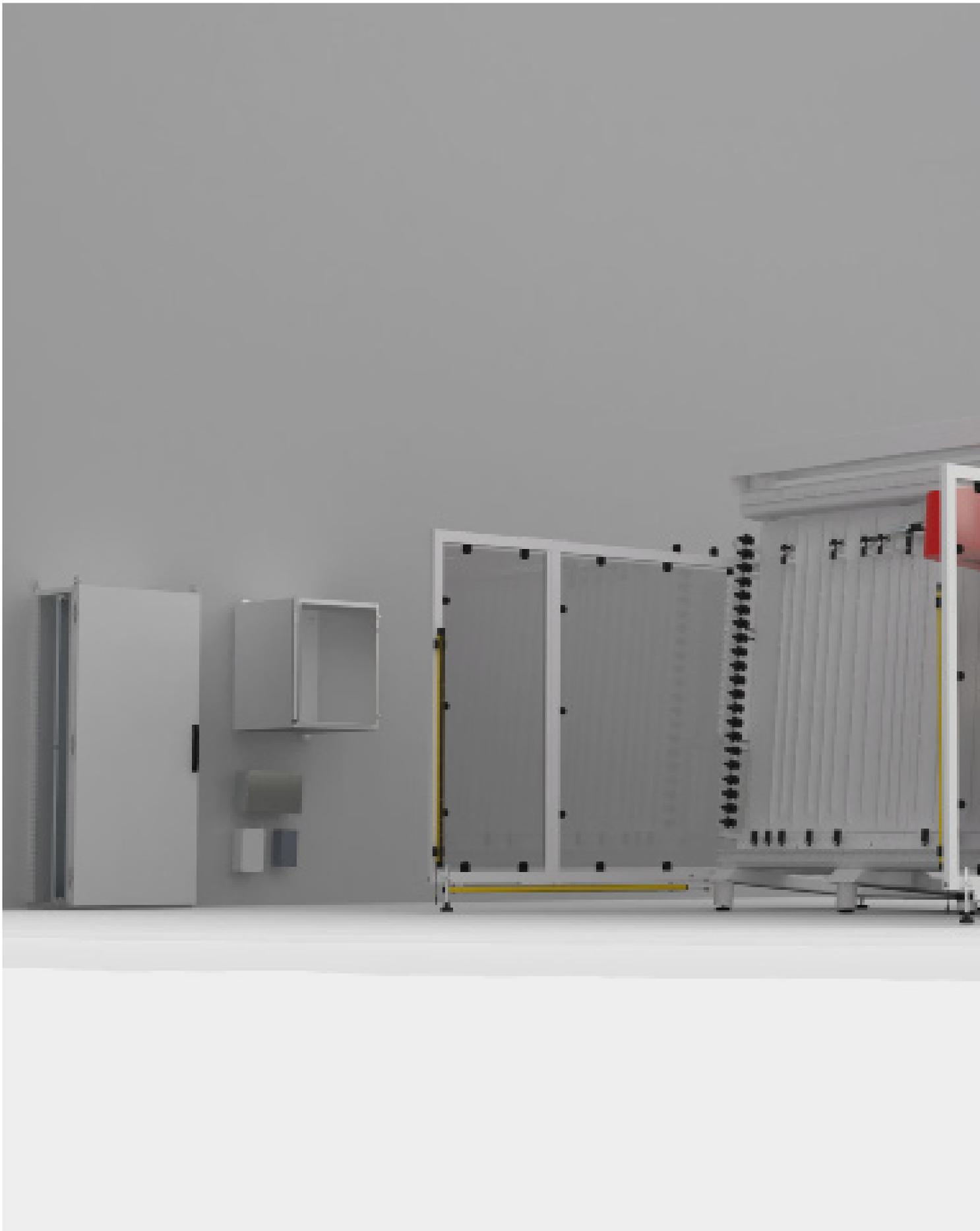



At nVent HOFFMAN we are focused on boosting your productivity and reducing your operational costs.

We offer a comprehensive range of modular electrical enclosures, digital tools to support engineering, and machines for panel shop automation.

If you need extra resources, Hoffman Certified Modification Centers, located at our distributors, offer rapid modification of standard enclosures.

Find your local
HOFFMAN Certified Modification Center:

<https://hoffman.nvent.com/en/hoffman/hoffman-modifications>



TAKE YO



FLOOR STANDING ENCLOSURES

MILD STEEL

STAINLESS STEEL

single door | double door

flange mount

single door

single door | double door

single door

IP 55
TYPE 12
IK 10

IP 55
TYPE 12
IK 10

IP 66
TYPE 4, 12
IK 10

IP 55
TYPE 12
IK 10

IP 66
TYPE 4X, 12
IK 10

H: 1800 - 2200

H: 1800 - 2000

H: 2000

H: 1800 - 2000

H: 2000

W: 400 - 1600

W: 800 - 1000

W: 800

W: 600 - 1200

W: 800

D: 400 - 800

D: 400 - 600

D: 600

D: 500 - 600

D: 600

OUR PICK!

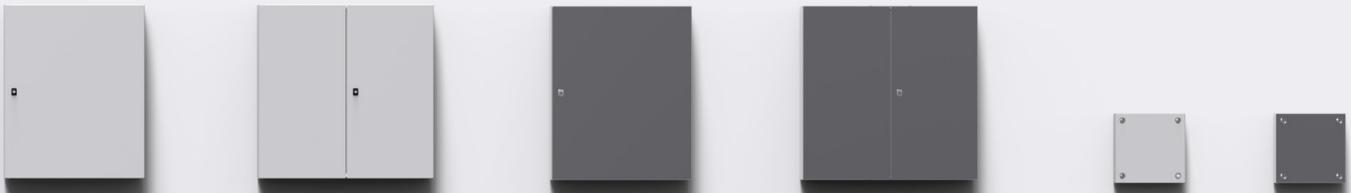

WALL MOUNTED ENCLOSURES

TERMINAL BOXES

MILD STEEL		STAINLESS STEEL		MILD STEEL	STAINLESS STEEL
single door	double door	single door	double door	box - plain cover	box - plain cover
IP 66 TYPE 4, 12 IK 10	IP 55 TYPE 12 IK 10	IP 66 TYPE 4X, 12 IK 10	IP 55 TYPE 12 IK 10	IP 66 TYPE 4, 12 IK 08	IP 66 TYPE 4X, 12 IK 08
H: 200 - 1200	H: 600 - 1400	H: 240 - 1400	H: 1000 - 1200	H: 150 - 400	H: 150 - 400
W: 200 - 800	W: 800 - 1200	W: 200 - 800	W: 1000 - 1200	W: 150 - 800	W: 150 - 800
D: 155 - 400	D: 300	D: 150 - 400	D: 300 - 400	D: 80 - 120	D: 80 - 120



Floor Standing Enclosures



**14 MINUTES
SAVED**

for each two bayed enclosures
with the below accessories

10 x BAYING BRACKETS

2 x SIDE PANELS

2 x MOUNTING PLATES

1 x FILLER PLATE

+ x PROFILES



FAST ASSEMBLY



Click-in
baying brackets



Click-in
mounting profiles



Click-in
filler plate



Mounting plate
fixation bracket

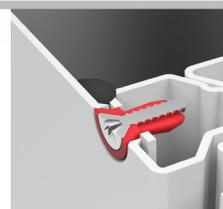

Click-in
side panel



Side panel
hanging

01

Floor Standing Enclosures



OPTIMUM PROTECTION



Two pins hinge



Locking system



Low water absorption gasket

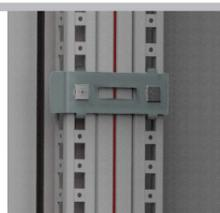

IP 66 baying kit

APPEALING DESIGN



Lock covers and lifting handles

Floor Standing
Mild Steel
Combinable, single door | MCS

IP 55 | TYPE 12 | IK 10



**Material:**

Frame: 1.5 mm painted steel. Door: 2 mm painted steel. Rear, roof and side panels: 1.5 mm painted steel. Mounting plate: 3 mm galvanized steel. Bottom plates: 1 mm galvanized steel.

Frame:

Seam welded reversed open profiles with 25 mm hole pattern, according to DIN 43660. Including integrated external hole pattern.

Door:

Mounted with four hinges allowing left or right hand opening. Including door frame with 25 mm hole pattern.

Rear panel:

Fitted by M6 torx screws. Standard facilities for rear door mounting.

Side panels:

Supplied as an accessory.

Roof panel:

Removable.

Lock:

Espagnolette 4-point locking system. Does not interfere with the enclosure inner space. Standard double-bit lock with 3 mm insert. Standard inserts, cylinders, lift handles and T-handles are available as accessories.

Bottom plates:

Consists of three or four (D>600) pieces.

Mounting plate:

Double folded and slides into position. Adjustable in depth by steps of 25 mm, with the MPD02 accessory. Supplied, attached on the outside of the enclosure packaging.

Earthing:

All panels are earthed through their fittings and are equipped with a separate earthing stud.

Finish:

RAL 7035 structured powder coating.

Protection:

Complies with IP 55 | TYPE 12 | IK 10.

Mounting requirements:

Standard delivery ready for combined installation. For stand-alone installation add side panels.

Delivery:

Frame with fitted door, rear panel, roof panel, bottom plates, mounting plate (not included for PER5 version) and door frame. For 400 mm wide enclosures, a mounting plate, bottom plates and door frame are not included. For enclosures 2200 mm height, delivery includes two CMB profiles mounted in depth. Delivery also includes earthing bolts. Delivered on a pallet which is identical to the width of the enclosure to allow baying without removal. All packing material is recyclable.



Dimensional table | MCS

IP 55 | TYPE 12 | IK 10

Cable enclosures: without MP, bottom plates and door frame

Enclosure dimensions			Item no.
H	W	D	
1800	400	400	MCS18044R5
1800	400	500	MCS18045R5
1800	400	600	MCS18046R5
2000	400	400	MCS20044R5
2000	400	500	MCS20045R5
2000	400	600	MCS20046R5
2000	400	800	MCS20048R5

With mounting plate

Enclosure dimensions			Mounting plate dimensions		Usable depth	Item no.
H	W	D	h	w	d	
1800	500	500	1694	394	459	MCS18055R5
1800	600	400	1694	494	359	MCS18064R5
1800	600	500	1694	494	459	MCS18065R5
1800	600	600	1694	494	559	MCS18066R5
1800	800	400	1694	694	359	MCS18084R5
1800	800	500	1694	694	459	MCS18085R5
1800	800	600	1694	694	559	MCS18086R5
1800	1000	400	1694	894	359	MCS18104R5
1800	1000	500	1694	894	459	MCS18105R5
1800	1000	600	1694	894	559	MCS18106R5
2000	500	500	1894	394	459	MCS20055R5
2000	600	400	1894	494	359	MCS20064R5
2000	600	500	1894	494	459	MCS20065R5
2000	600	600	1894	494	559	MCS20066R5
2000	600	800	1894	494	759	MCS20068R5
2000	800	400	1894	694	359	MCS20084R5
2000	800	500	1894	694	459	MCS20085R5
2000	800	600	1894	694	559	MCS20086R5
2000	800	800	1894	694	759	MCS20088R5
2000	1000	400	1894	894	359	MCS20104R5
2000	1000	500	1894	894	459	MCS20105R5
2000	1000	600	1894	894	559	MCS20106R5
2000	1000	800	1894	894	759	MCS20108R5
2200	600	600	2094	494	559	MCS22066R5
2200	600	800	2094	494	759	MCS22068R5
2200	800	600	2094	694	559	MCS22086R5
2200	800	800	2094	694	759	MCS22088R5

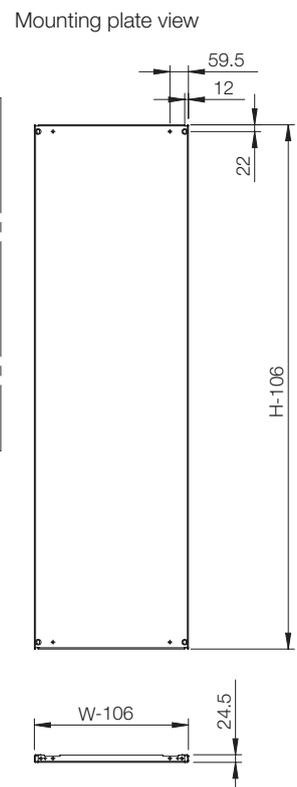
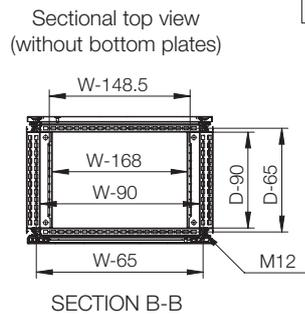
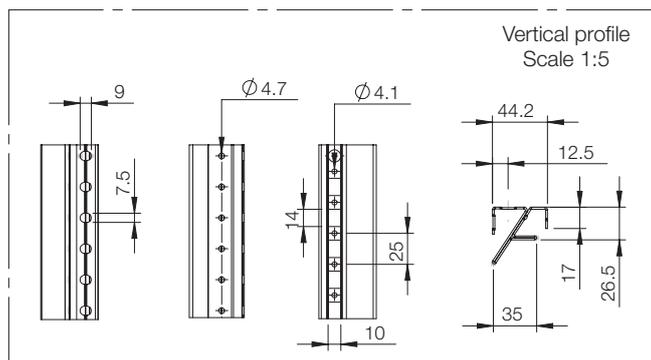
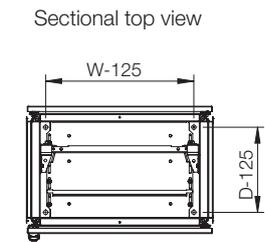
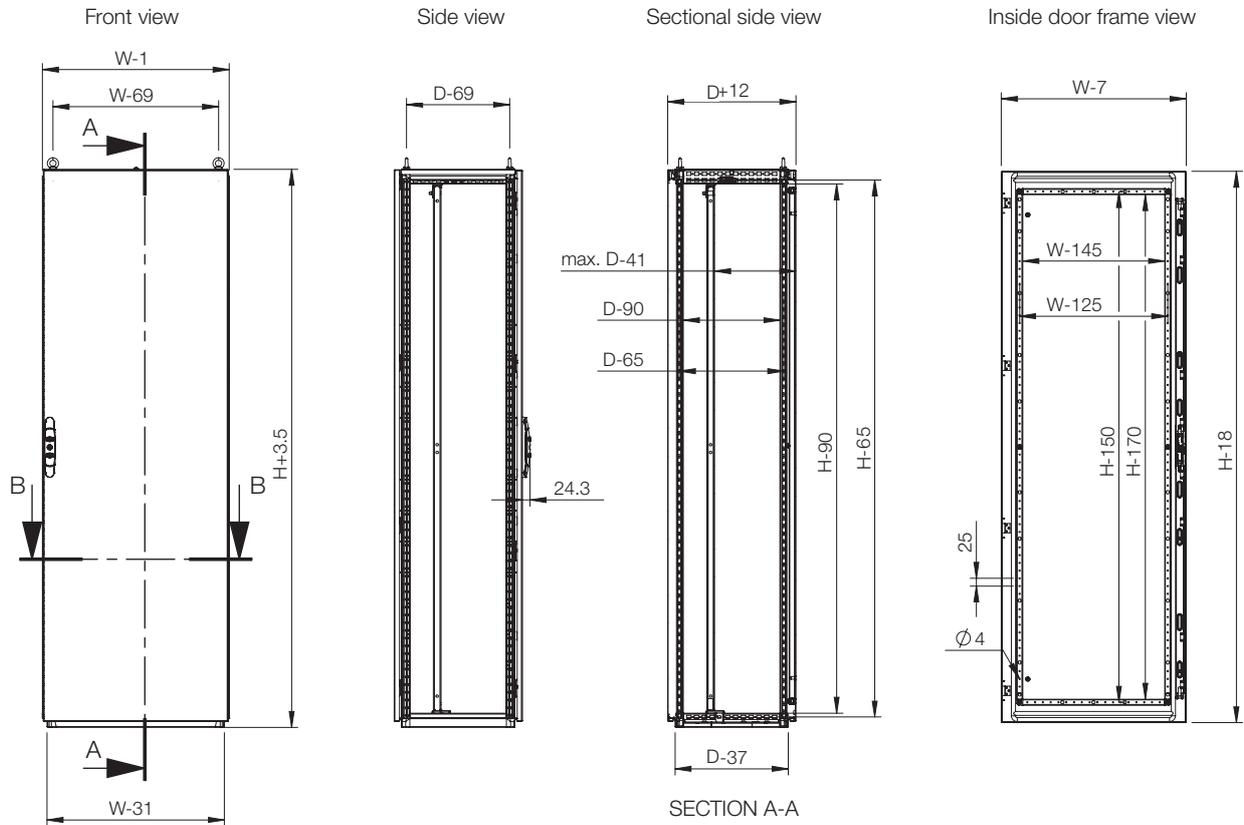

Floor Standing
Mild Steel
Combinable, double door | MCD

IP 55 | TYPE 12 | IK 10



01

Floor Standing Enclosures

1

Material:

Frame: 1.5 mm painted steel. Doors: 2 mm painted steel. Rear, roof and side panels: 1.5 mm painted steel. Mounting plate: 3 mm galvanized steel. Bottom plates: 1 mm galvanized steel.

Frame:

Seam welded reversed open profiles with 25 mm hole pattern, according to DIN 43660. Including integrated external hole pattern.

Doors:

Mounted with four hinges. Including door frame with 25 mm hole pattern. Doors cannot be reversed. Separate doors to be ordered for left hand door locking.

Rear panel:

Fitted by M6 torx screws. Standard facilities for rear doors mounting. Split rear panels in 1600 mm wide enclosures.

Side panels:

Supplied as an accessory.

Roof panel:

Removable.

Lock:

Espagnolette 4-point locking system in the main door and 2-point locking system in the slave door. Standard double-bit lock with 3 mm insert. Standard inserts, cylinders, lift handles and T-handles are available as accessories.

Bottom plates:

Consists of three or four (D>600) pieces.

Mounting plate:

Double folded and slides into position. Adjustable in depth by steps of 25 mm, with the MPD02 accessory. Supplied, attached on the outside of the enclosure packaging.

Earthing:

All panels are earthed through their fittings and equipped with a separate earthing stud.

Finish:

RAL 7035 structured powder coating.

Protection:

Complies with IP55 | TYPE 12 | IK 10.

Mounting requirements:

Standard delivery ready for combined installation. For stand-alone installation add side panels.

Delivery:

Frame with fitted doors, rear panel, roof panel, bottom plates, mounting plate and door frame (not included for PER5 version). For enclosures 2200 mm height, delivery includes two CMB profiles mounted in depth. Delivery also includes earthing bolts. Delivered on a pallet which is identical to the width of the enclosure to allow baying without removal. Packing material is recyclable.



Dimensional table | MCD

IP 55 | TYPE 12 | IK 10

With mounting plate

Enclosure dimensions			Mounting plate dimensions		Usable depth	Item no.
H	W	D	h	w	d	
1800	800	500	1694	694	459	MCD18085R5
1800	1000	400	1694	894	359	MCD18104R5
1800	1000	500	1694	894	459	MCD18105R5
1800	1200	400	1694	1094	359	MCD18124R5
1800	1200	500	1694	1094	459	MCD18125R5
1800	1200	600	1694	1094	559	MCD18126R5
1800	1600	400	1694	1494	359	MCD18164R5
2000	800	500	1894	694	459	MCD20085R5
2000	800	600	1894	694	559	MCD20086R5
2000	1000	400	1894	894	359	MCD20104R5
2000	1000	500	1894	894	459	MCD20105R5
2000	1000	600	1894	894	559	MCD20106R5
2000	1000	800	1894	894	759	MCD20108R5
2000	1200	400	1894	1094	359	MCD20124R5
2000	1200	600	1894	1094	559	MCD20126R5
2000	1200	500	1894	1094	459	MCD20125R5
2000	1200	800	1894	1094	759	MCD20128R5
2000	1600	500	1894	1494	459	MCD20165R5
2000	1600	600	1894	1494	559	MCD20166R5
2200	1000	600	2094	894	559	MCD22106R5
2200	1200	600	2094	1094	559	MCD22126R5
2000	1600	400	1894	1494	359	MCD20164R5
2000	800	800	1894	694	694	MCD20088R5

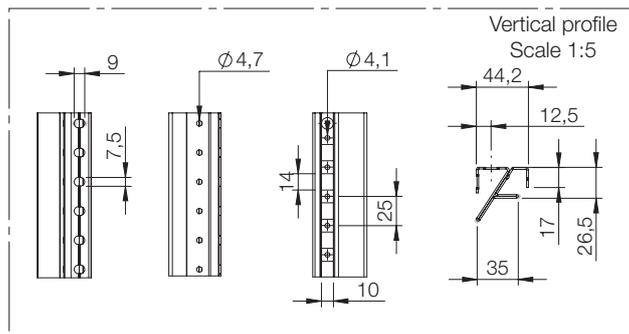
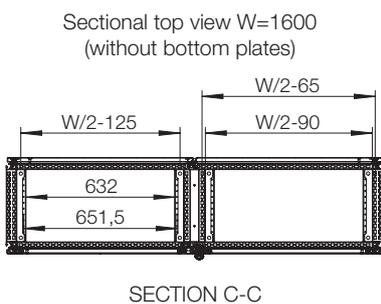
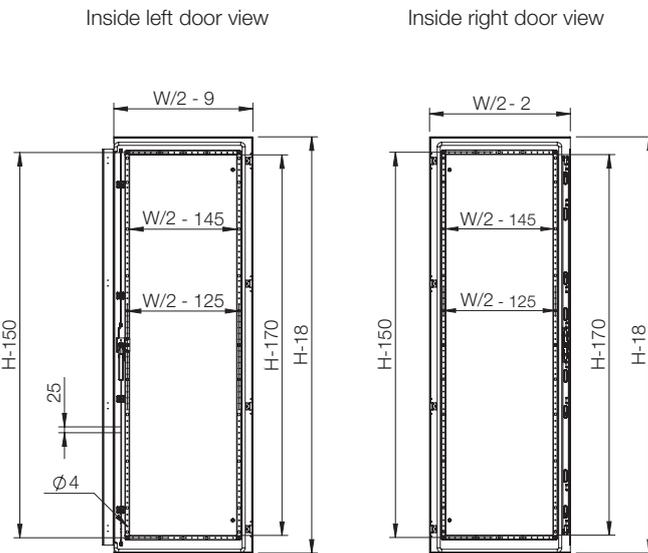
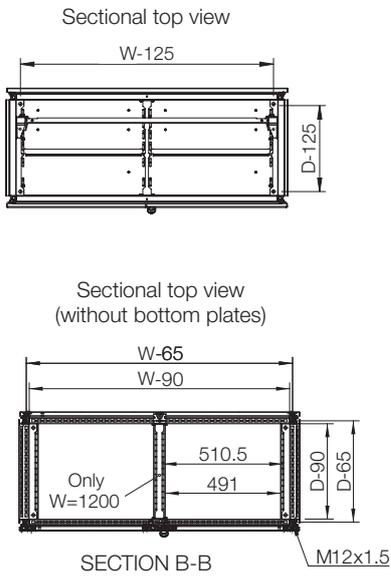
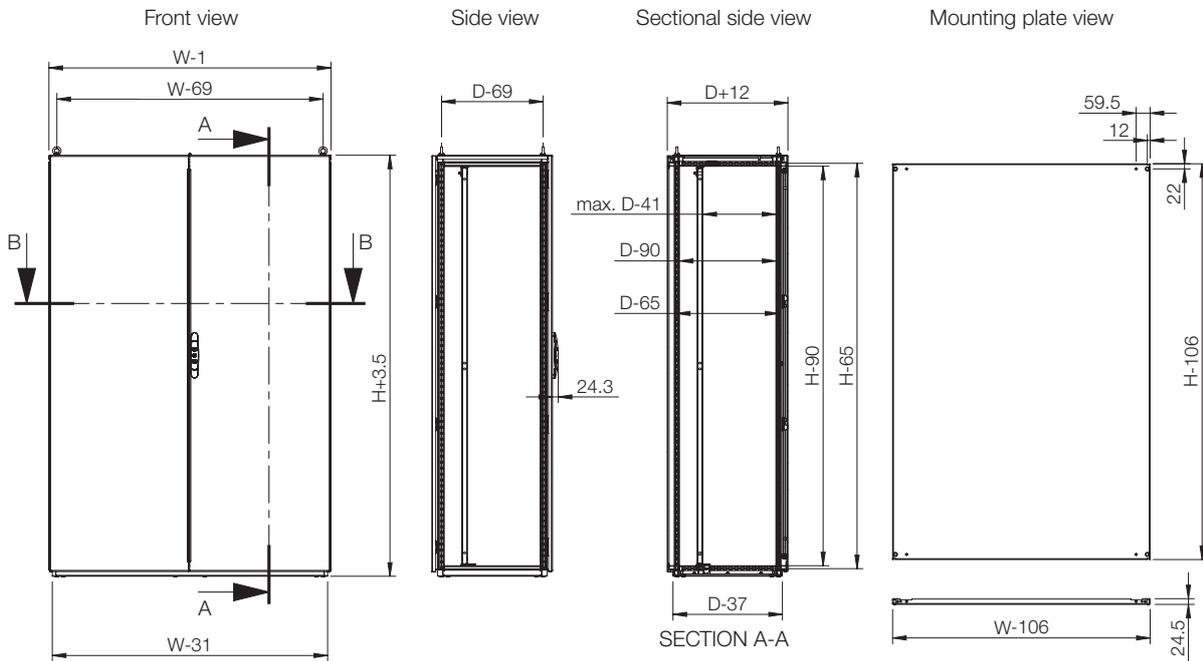

Floor Standing
Mild Steel
Combinable, single door | MCS-HP

IP 66 | TYPE 4, 12 | IK 10



01

Floor Standing Enclosures

1

Material:

Frame: 1.5 mm painted steel. Door: 2 mm painted steel. Rear, roof and side panels: 1.5 mm painted steel. Mounting plate: 3 mm galvanized steel. Bottom plates: 1 mm galvanized steel.

Frame:

Seam welded reversed open profiles with 25 mm hole pattern according to DIN 43660. Including integrated external hole pattern.

Door:

Mounted with four hinges allowing left or right hand opening. Including door frame with 25 mm hole pattern.

Rear panel:

Fitted by M6 torx screws. Standard facilities for rear door mounting.

Side panels:

Supplied as an accessory.

Roof panel:

Removable.

Lock:

Espagnolette 4-point locking system. Does not interfere with the enclosure inner space. Standard double-bit lock with 3 mm insert. Standard inserts, cylinders, lift handles and T-handles are available as accessories.

Bottom plates:

One piece bottom plate, with injected polyurethane gasket to ensure maximum sealing.

Mounting plate:

Double folded and slides into position. Adjustable in depth by steps of 25 mm, with the MPD02 accessory. Supplied, attached on the outside of the enclosure packaging.

Earthing:

All panels are earthed through their fittings and are equipped with a separate earthing stud.

Finish:

RAL 7035 structured powder coating.

Protection:

Complies with IP 66 | TYPE 4, 12 | IK 10.

Mounting requirements:

Standard delivery ready for combined installation. For stand-alone installation add side panels.

Delivery:

Frame with fitted door, rear panel, roof panel, bottom plate, mounting plate and door frame. Delivery also includes earthing bolts. Delivered on a pallet which is identical to the width of the enclosure to allow buying without removal. All packing material is recyclable.

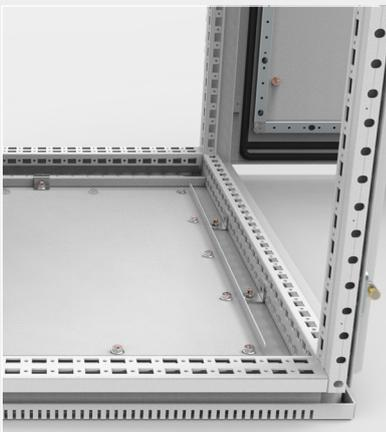

Dimensional table | MCS-HP

IP 66 | TYPE 4, 12 | IK 10

Enclosure dimensions			Mounting plate dimensions		Usable depth	Item no.
H	W	D	h	w	d	
2000	800	600	1894	694	559	MCS20086HP

**Other dimensions available on request. Special side panel is required if depth is greater than 700 mm.*

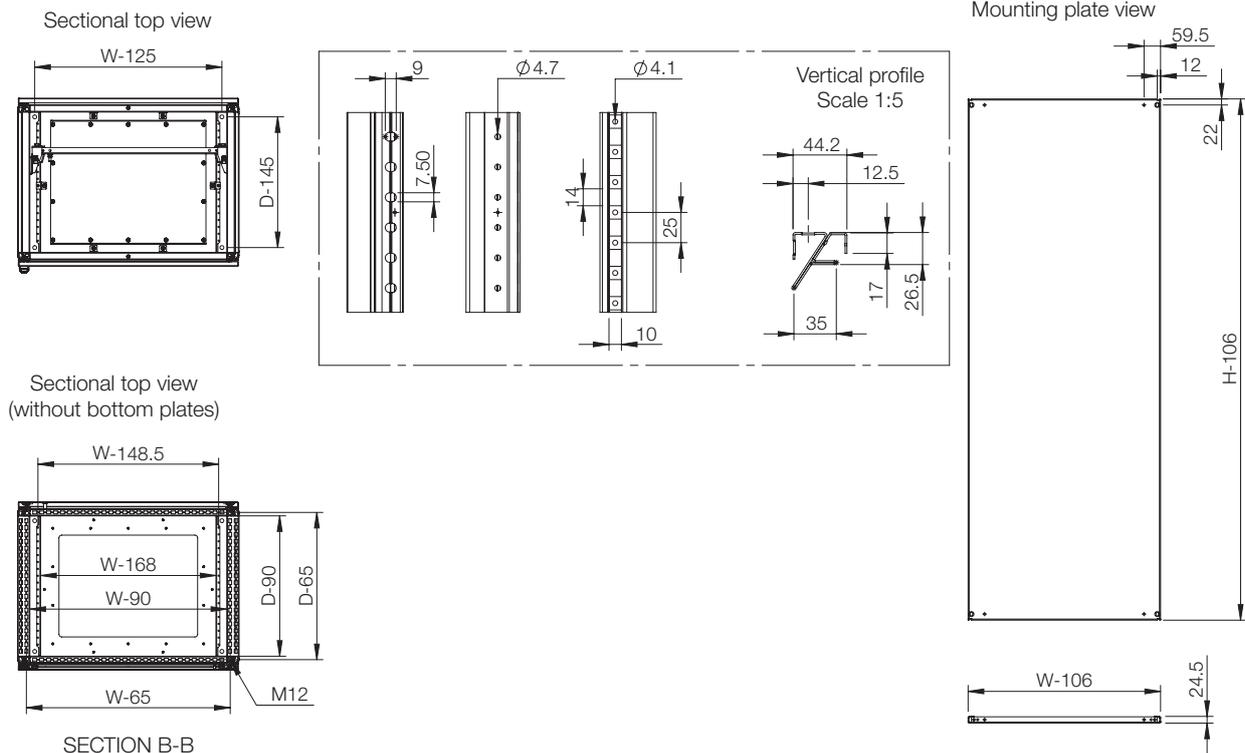
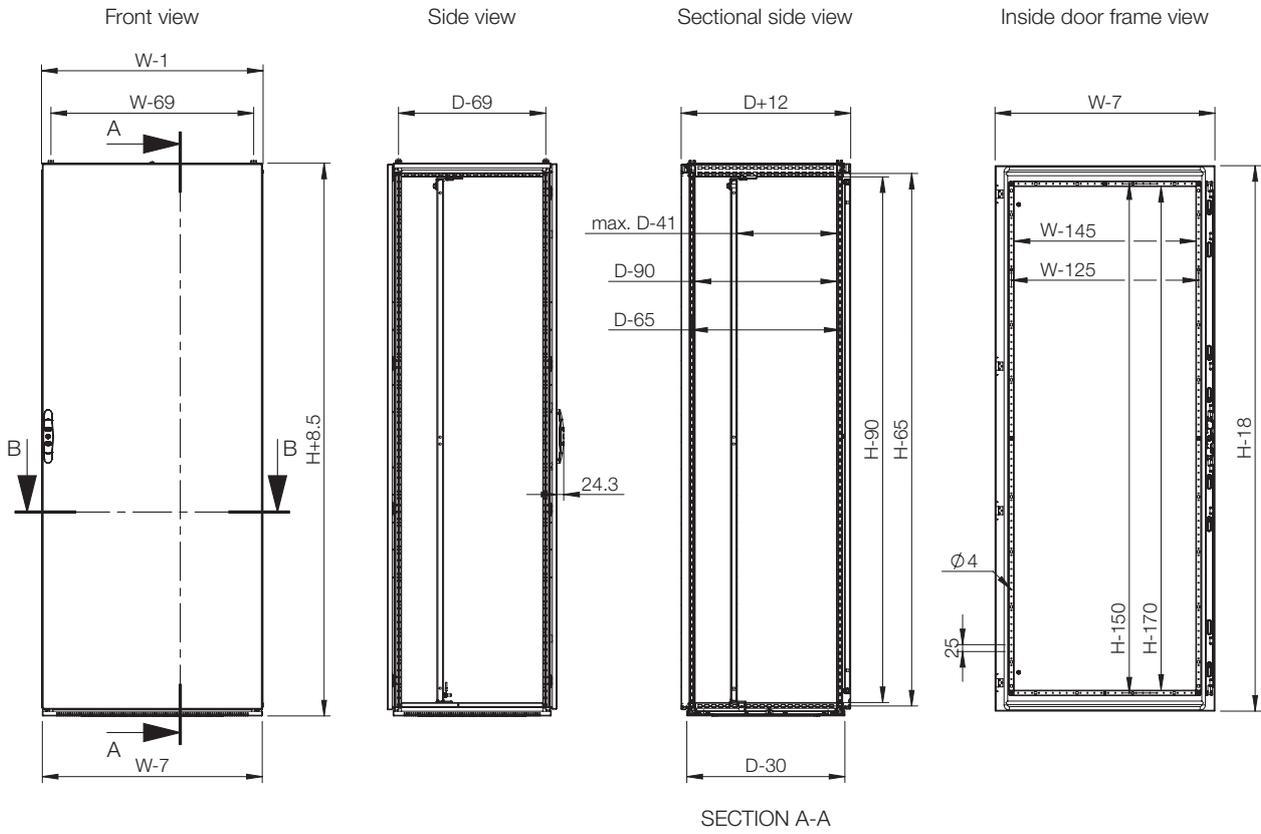

**Floor Standing
Mild Steel
Flange Mount Disconnect | MCF**

IP 55 | TYPE 12 | IK 10



Material:

Frame: 1.5 mm painted steel. Doors: 2 mm painted steel. Rear, roof and side panels: 1.5 mm painted steel. Mounting plate: 3 mm galvanized steel. Bottom plates: 1 mm galvanized steel.

Frame:

Seam welded reversed open profiles with 25 mm hole pattern, according to DIN 43660. Including integrated external hole pattern.

Door:

Mounted with four hinges. Including door frame with 25 mm hole pattern. Door can not be reversed. Flange door: Surface mounted with hinges, locked from the inside, including universal cut-out.

Rear panel:

Fitted by M6 torx screws. Standard facilities for rear door mounting.

Side panels:

Supplied as an accessory.

Roof panel:

Removable.

Lock:

Lock, left door: Espagnolette 4-point locking system. Does not interfere with the enclosure inner space. Standard double-bit lock with 3 mm insert. Standard inserts, cylinders, lift handles and T-handles are available as accessories. Lock, right door: Top and bottom lock with double-bit for easy opening of the door. Double-bit 3 mm insert and 90° movement. Other inserts are available as an accessory.

Bottom plates:

Consists of three pieces.

Mounting plate:

Double folded and adjustable in depth by steps of 25 mm, with the MPD02 accessory. Supplied, attached on the outside of the enclosure packaging.

Earthing:

All panels are earthed through their fittings and are equipped with a separate earthing stud.

Finish:

RAL 7035 structured powder coating.

Protection:

Complies with IP 55 | TYPE 12 | IK 10.

Mounting requirements:

Standard delivery ready for combined installation. Sides of the group of combined enclosures must be closed with side panels SPM. To complete the interlocking system add FMD in this master enclosure and FMA, FMB, FMS in the slave enclosures.

Delivery:

Frame with fitted doors, rear panel, roof panel, bottom plates, mounting plate and door frame. Delivery also includes earthing bolts. Delivered on a pallet which is identical to the width of the enclosure to allow baying without removal. All packing material is recyclable.



Dimensional table | MCF

IP 55 | TYPE 12 | IK 10

Enclosure dimensions			Mounting plate dimension	
H	W	D	w	Item no.
1800	800	400	800	MCF18084R5
1800	800	500	800	MCF18085R5
1800	1000	500	1000	MCF18105R5
2000	800	500	800	MCF20085R5
2000	800	600	800	MCF20086R5
2000	1000	500	1000	MCF20105R5

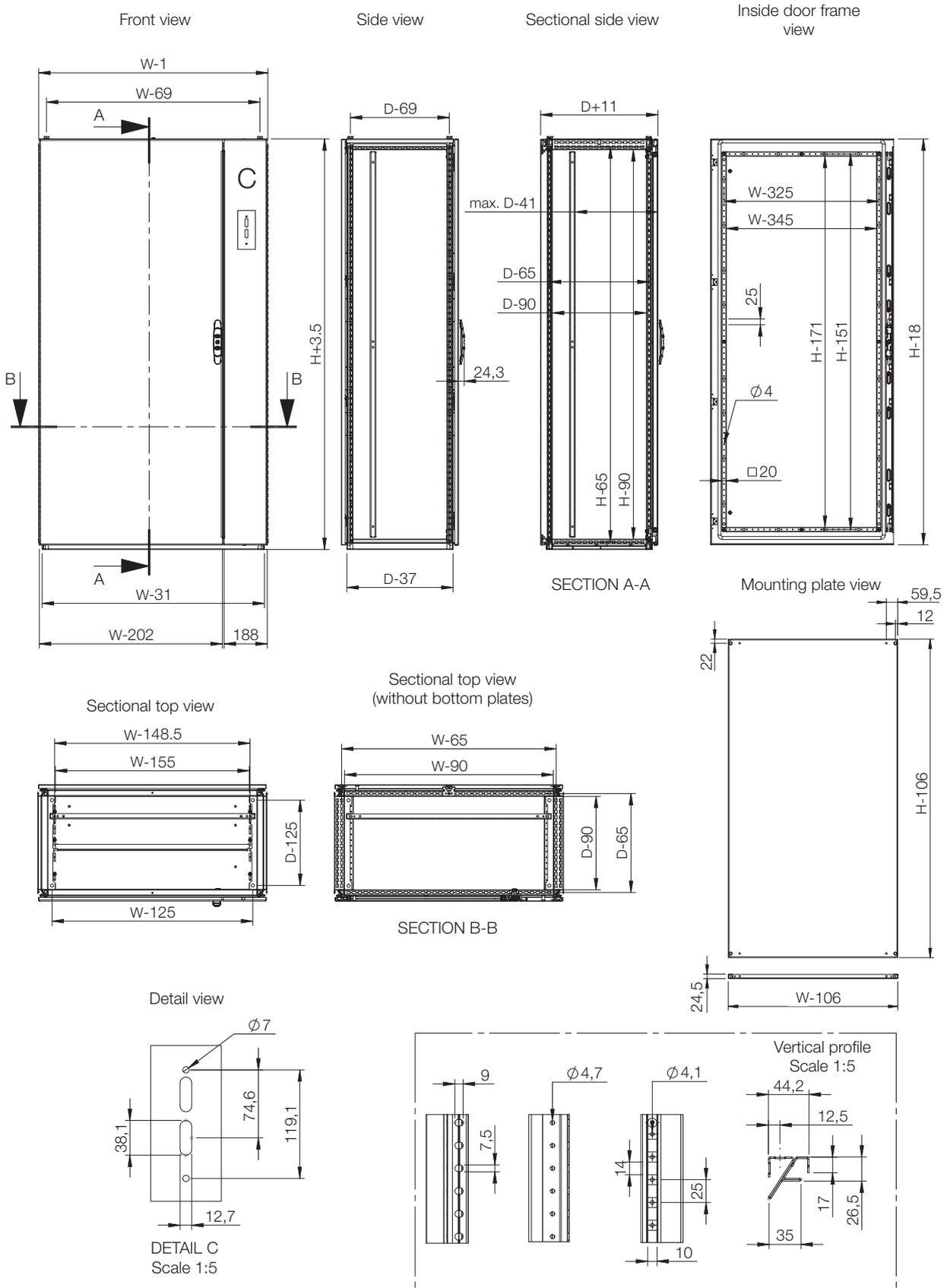

**Floor Standing
Stainless Steel
Combinable, single door | MCSS**

IP 55 | TYPE 12 | IK 10



Material:

AISI 304L pre-grained stainless steel / AISI 316L. Frame: 1.5 mm. Door: 2 mm. Rear, roof and side panels: 1.5 mm. Bottom plates: 1.5 mm stainless steel. Mounting plate: 3 mm galvanized steel.

Frame:

Seam welded reversed open profiles with 25 mm hole pattern, according to DIN 43660.

Door:

Mounted with four hinges allowing left or right hand opening. Including door frame with 25 mm hole pattern.

Rear panel:

Fitted by M6 torx screws. Standard facilities for rear door mounting.

Side panels:

Supplied as an accessory.

Roof panel:

Removable.

Lock:

Espagnolette 4-point locking system. Does not interfere with the enclosure inner space. Standard double-bit 3 mm insert. Standard inserts, cylinders, lift handles and T-handle are available as accessories.

Bottom plates:

One piece bottom plate, with injected polyurethane gasket to ensure maximum sealing.

Mounting plate:

Double folded and slides into position. Adjustable in depth by steps of 25 mm, with the MPD02 accessory. Mounting plate is supplied, attached on the outside of the enclosure packaging.

Earthing:

All panels are earthed through their fittings and are equipped with a separate earthing stud.

Finish:

400 pre-grained stainless steel.

Protection:

Corresponds with IP 55 | TYPE 12 | IK 10.

Mounting requirements:

Standard delivery ready for combined installation. For stand-alone installation, add side panels.

Delivery:

Frame with fitted door, rear panel, roof panel, bottom plate, mounting plate and door frame. Delivery also includes earthing bolts. Delivered on a pallet which is identical to the width of the enclosure to allow baying without removal. All packing material is recyclable.



Dimensional table | MCSS

IP 55 | TYPE 12 | IK 10

Enclosure dimensions			Mounting plate dimensions		Item no.
H	W	D	h	w	
1800	600	500	1694	494	MCSS18065
1800	800	500	1694	694	MCSS18085
2000	600	600	1894	494	MCSS20066
2000	800	600	1894	694	MCSS20086

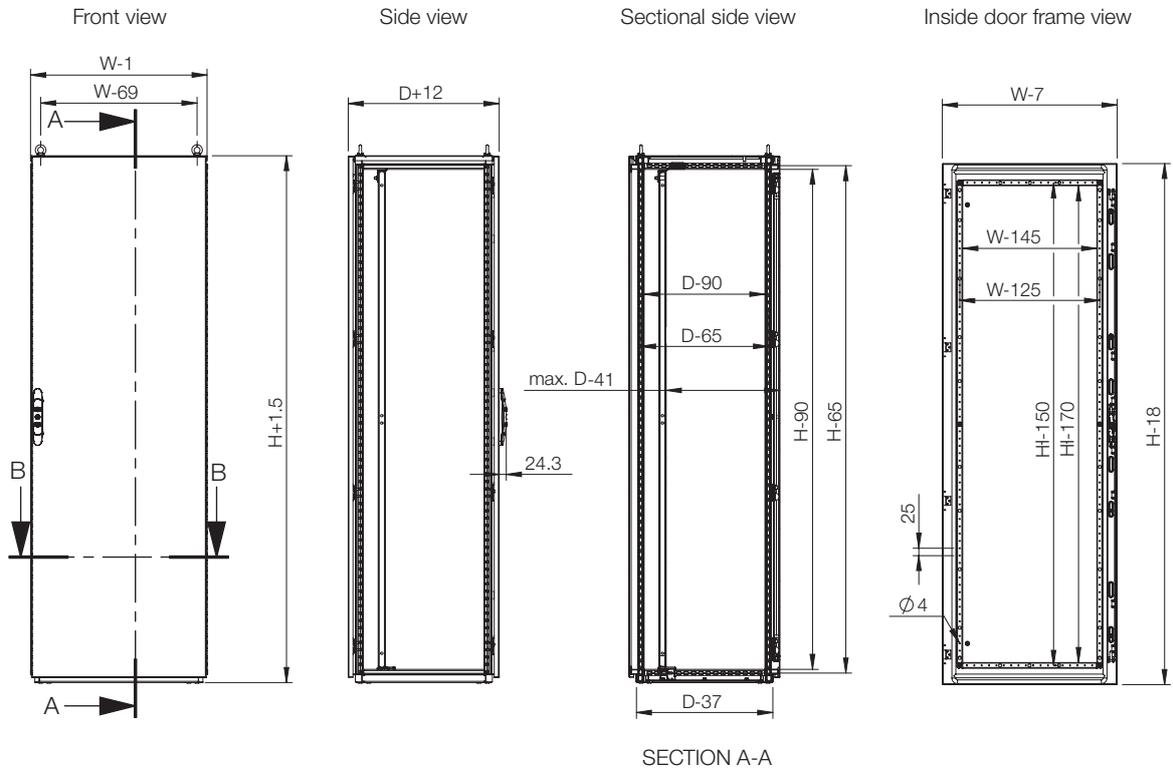

Sectional top view

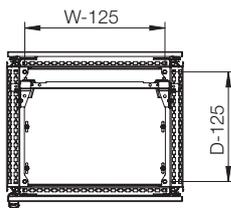

Sectional top view (without bottom plates)

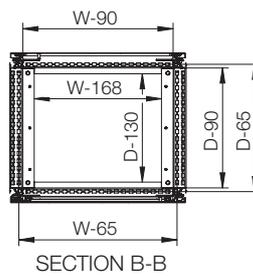

Mounting plate view

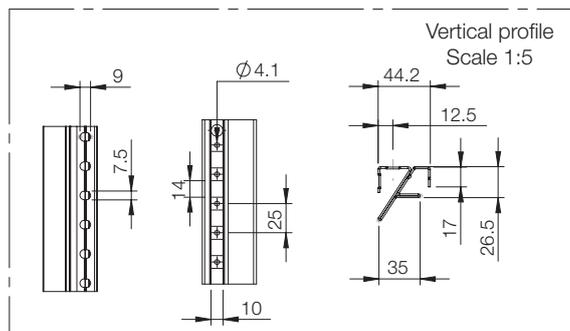
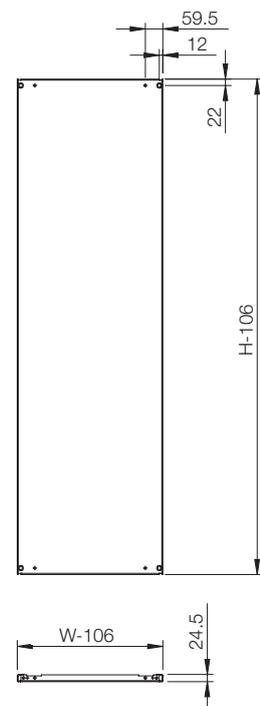

**Floor Standing
Stainless Steel
Combinable, double door | MCDS**

IP 55 | TYPE 12 | IK 10



Material:

AISI 304L pre-grained stainless steel / AISI 316L. Frame: 1.5 mm. Door: 2 mm. Rear, roof and side panels: 1.5 mm. Bottom plates: 1.5 mm stainless steel. Mounting plate: 3 mm galvanized steel.

Frame:

Seam welded reversed open profiles with 25 mm hole pattern, according to DIN 43660.

Door:

Mounted with four hinges. Including door frame with 25 mm hole pattern. Doors cannot be reversed. Separate doors to be ordered for left hand door locking.

Rear panel:

Fitted by M6 torx screws. Standard facilities for rear door mounting. Split rear panels in 1600 mm wide enclosures.

Side panels:

Supplied as an accessory.

Roof panel:

Removable.

Lock:

Espagnolette 4-point locking system in the main door and 2-point locking system in the slave door. Standard double-bit lock with 3 mm insert. Standard inserts, cylinders, lift handles and T-handle are available as accessories.

Bottom plates:

Two piece bottom plate in 1200 mm width, with injected polyurethane gasket to ensure maximum sealing.

Mounting plate:

Double folded and adjustable in depth by steps of 25 mm, with the MPD02 accessory. Mounting plate is delivered, attached on the outside of the enclosure packaging.

Earthing:

All panels are earthed through their fittings and are equipped with a separate earthing stud.

Finish:

400 pre-grained stainless steel.

Protection:

Complies with IP 55 | TYPE 12 | IK 10.

Mounting requirements:

Standard delivery ready for combined installation. For stand-alone installation, add side panels.

Delivery:

Frame with fitted doors, rear panel, roof panel, bottom plates, mounting plate and door frame. Delivery also includes earthing bolts. Delivered on a pallet which is identical to the width of the enclosure to allow baying without removal. Packing material is recyclable.



Dimensional table | MCDS

IP 55 | TYPE 12 | IK 10

Enclosure dimensions			Mounting plate dimensions		Item no.
H	W	D	h	w	
2000	1200	600	1894	1094	MCDS20126

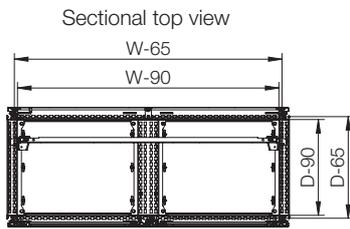
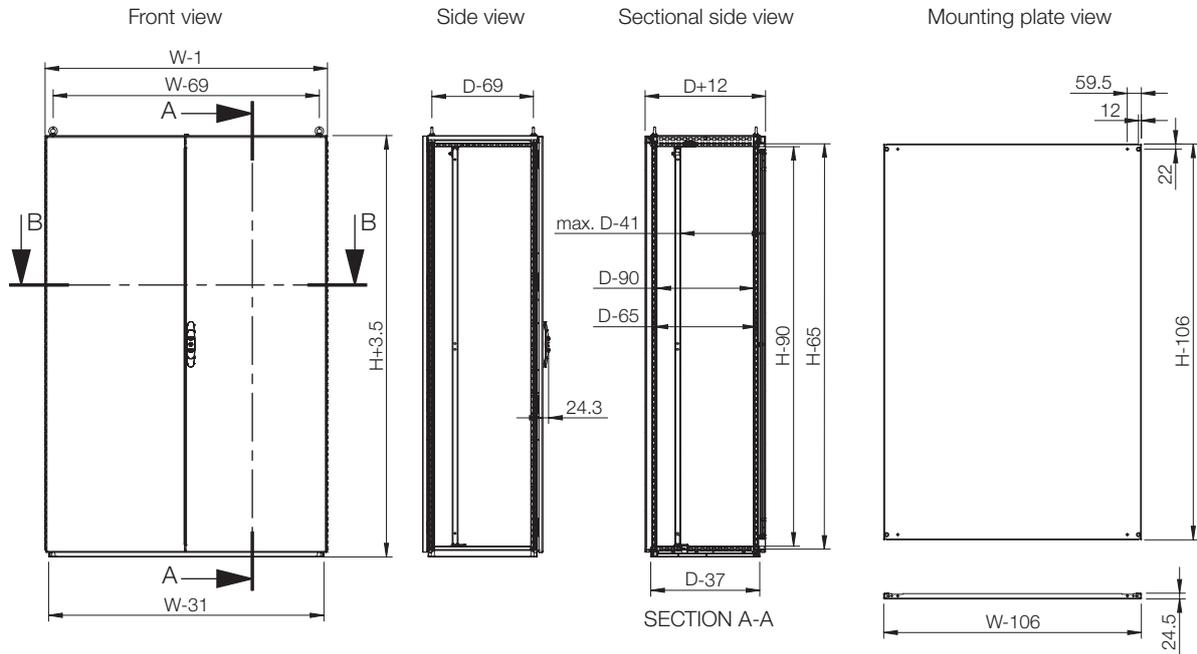

Inside left door view

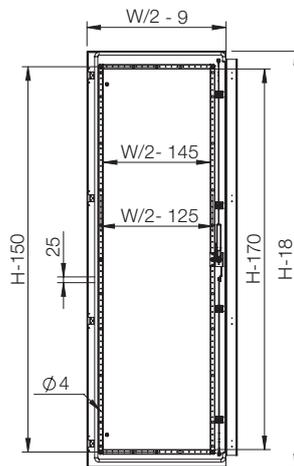

Inside right door view

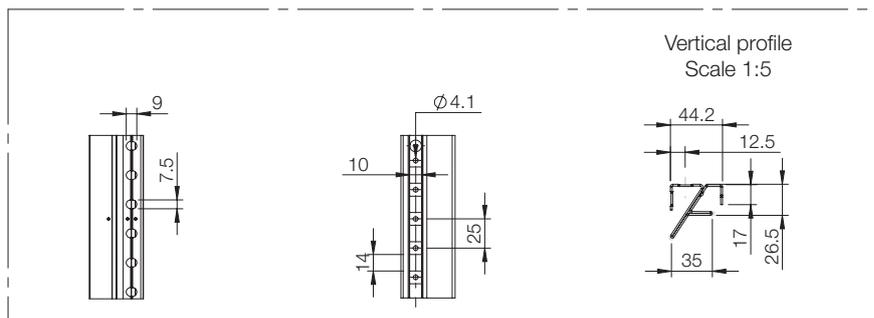
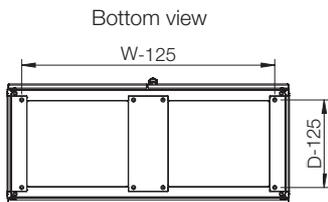
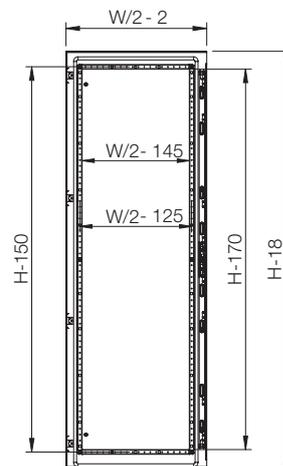

**Floor Standing
Stainless Steel
Combinable, single door | MCSS-HP**

IP 66 | TYPE 4X, 12 | IK 10



**Material:**

AISI 304L pre-grained stainless steel / AISI 316L. Frame: 1.5 mm. Door: 2 mm. Rear, roof and side panels: 1.5 mm. Bottom plates: 1.5 mm stainless steel. Mounting plate: 3 mm galvanized steel.

Frame:

Seam welded reversed open profiles with 25 mm hole pattern, according to DIN 43660. Including integrated external hole pattern.

Door:

Mounted with four hinges, allowing left or right hand opening. Including door frame with 25 mm hole pattern.

Rear panel:

Fitted by M6 torx screws. Standard facilities for rear door mounting.

Side panels:

Supplied as an accessory.

Roof panel:

Removable.

Lock:

Espagnolette 4-point locking system. Does not interfere with the enclosure inner space. Standard double-bit lock with 3 mm insert. Standard inserts, cylinders, lift handles and T-handles are available as accessories.

Bottom plates:

One piece bottom plate, with injected polyurethane gasket to ensure maximum sealing.

Mounting plate:

Double folded and slides into position. Adjustable in depth by steps of 25 mm, with the MPD02 accessory. Mounting plate is supplied, attached on the outside of the enclosure packaging.

Earthing:

All panels are earthed through their fittings and are equipped with a separate earthing stud.

Finish:

400s pre-grained stainless steel (0.5 microns average).

Protection:

Complies with IP 66 | TYPE 4X, 12 | IK 10.

Mounting requirements:

For stand-alone installation, add side panels. For combined installation, HPPG01 and baying brackets, CCI and CCM are required.

Delivery:

Frame with fitted door, rear panel, roof panel, bottom plate, mounting plate and door frame. Delivery also includes earthing bolts. Delivered on a pallet which is identical to the width of the enclosure to allow baying without removal. All packing material is recyclable.



Dimensional table | MCSS-HP

IP 66 | TYPE 4X, 12 | IK 10

Enclosure dimensions			Mounting plate dimensions		Usable depth	Item no.
H	W	D	h	w	d	
2000	800	600	1894	694	559	MCSS20086HP

**Other dimensions available on request. Special side panel is required if depth is greater than 700 mm.*

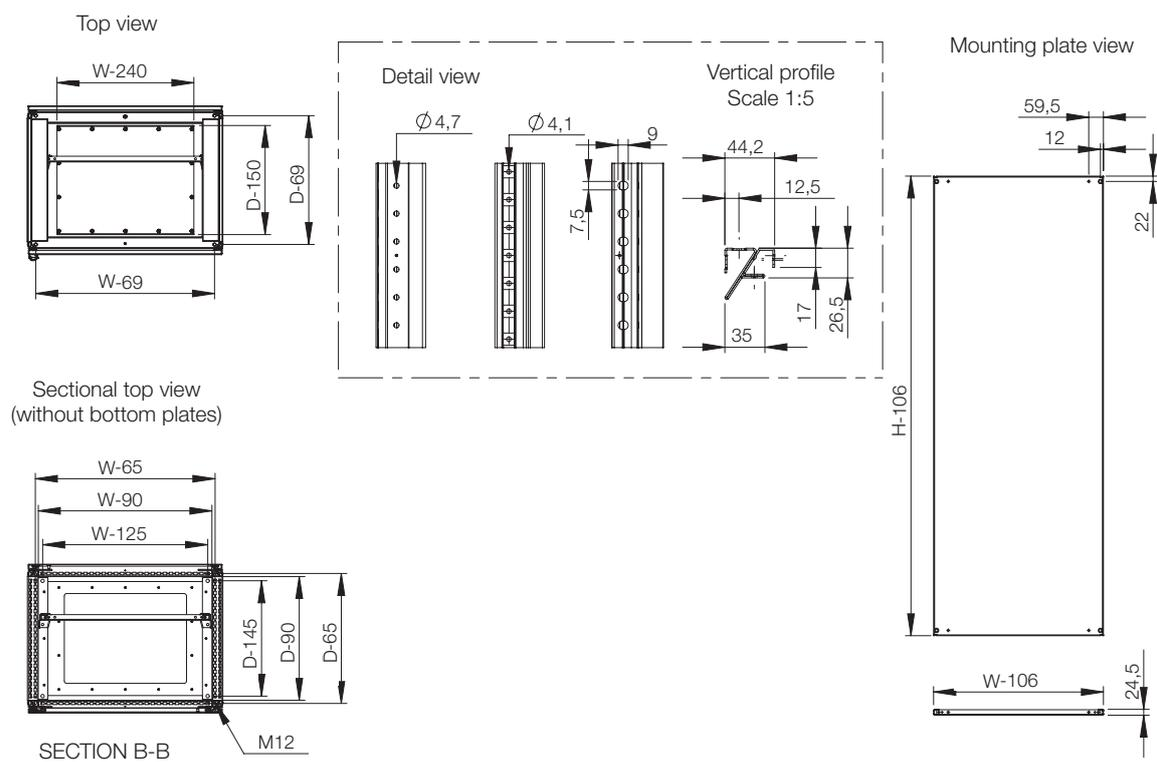
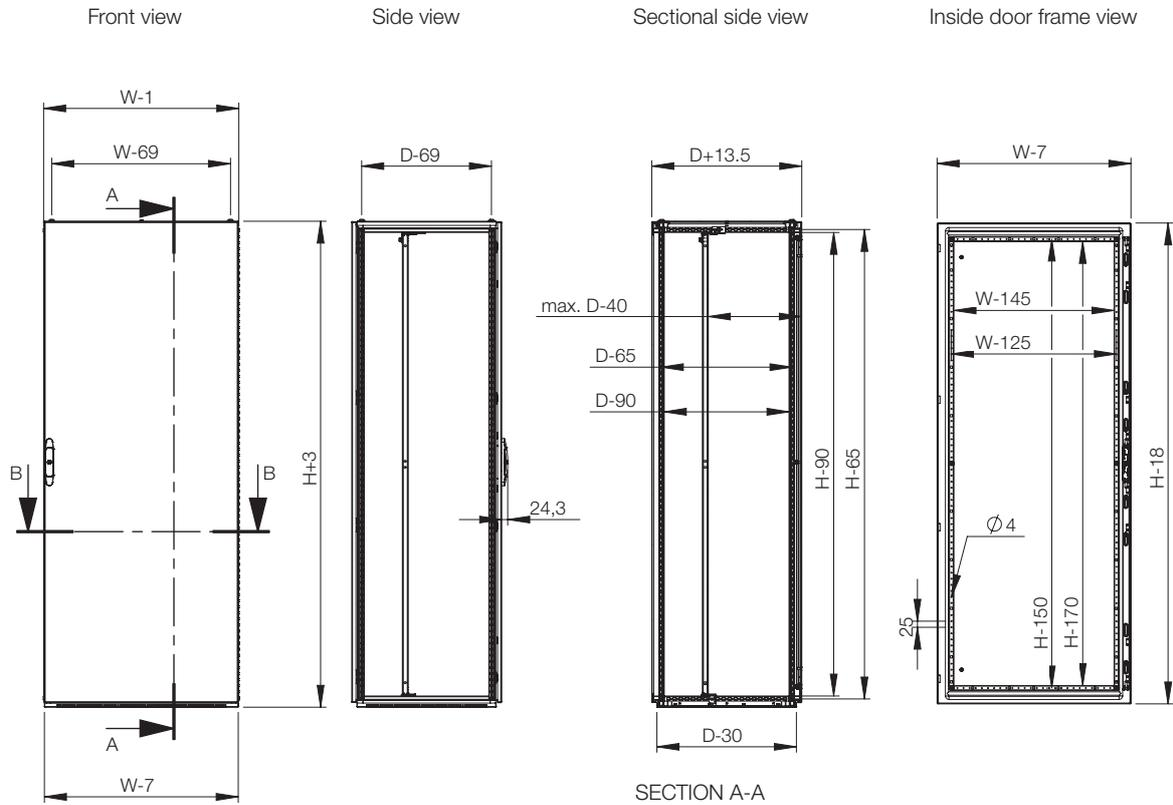

Floor Standing Enclosures

Accessories

Mounting plates, MP

- Description:** Standard mounting plate. It can also be mounted on the side of an enclosure by using MPS kit or slid in from the side with the MTS profile. For heavy loads in vibrating environments use mounting plate reinforcement profile MPR and MPE or MPEF brackets.
- Material:** 3 mm galvanized steel.
- Pack quantity:** 1 piece.
- Maximum load:** 6000 N.
- Mounting requirements:** Use MPA for mounting the MP inside the enclosure. Adjustable in depth with MPD accessory.

For enclosure		Mounting plate dimensions		Item no.
H	W	h	w	
1800	400	1694	294	MP1804
1800	500	1694	394	MP1805
1800	600	1694	494	MP1806
1800	800	1694	694	MP1808
1800	1000	1694	894	MP1810
1800	1200	1694	1094	MP1812
1800	1600	1694	1494	MP1816
2000	400	1894	294	MP2004
2000	500	1894	394	MP2005
2000	600	1894	494	MP2006
2000	800	1894	694	MP2008
2000	1000	1894	894	MP2010
2000	1200	1894	1094	MP2012
2000	1600	1894	1494	MP2016
2200	600	2094	494	MP2206
2200	800	2094	694	MP2208
2200	1000	2094	894	MP2210
2200	1200	2094	1094	MP2212

500 mm width mounting plates for side mounting available on request.
 1600 mm wide mounting plates are supplied as two 800 mm wide mounting plates along with a MPF filler plate.



Mounting plate brackets for rear mounting, MPA-R

Description: To fix mounting plates to the enclosure from rear. The kit includes brackets for fixing the mounting plate flush with the enclosure frame or set back behind the enclosure frame, adding +20mm of useful depth for mounting components. These brackets are needed when rear fixation is required or when the enclosure is ordered without the mounting plate (PE) as an alternative to MPA06/MPA04. Unmounting from both the front and rear is possible.

Material: 3 mm zinc plated steel.

Pack quantity: 2 top brackets, 2 bottom brackets, 2 brackets for flushing the mounting plate with the frame and 2 brackets for setting the mounting plate back behind the frame with mounting accessories.



Description	Item no.
MP brackets rear mounting	MPA04R

Mounting plate brackets, MPA-P

Description: To fix mounting plates in the enclosure, including brackets for depth adjustment in steps of 25 mm. Brackets are needed when an extra mounting plate is required or when the enclosure is ordered without mounting plate (PE).

Material: 3 mm zinc plated steel.

Pack quantity: 2 top brackets, 2 bottom sliding brackets and 2 adjustment brackets with mounting accessories.

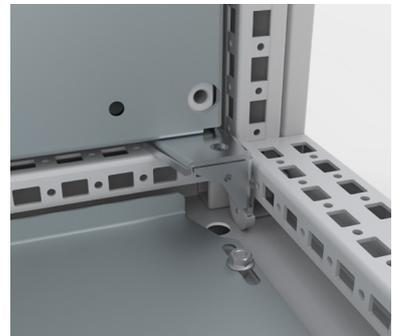

Item no.
MPA06

Floor Standing Enclosures

Accessories

Mounting plate adjustment brackets, MPD

- Description:** Brackets to adjust the mounting plate in depth by steps of 25 mm in the enclosure frame.
- Material:** 3 mm zinc plated steel.
- Pack quantity:** 2 brackets with mounting accessories.

Item no.
MPD02

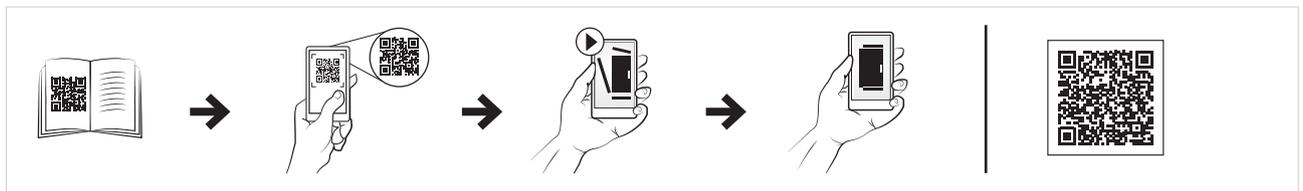

Mounting brackets rear fixing, MPA-RF

- Description:** To fix mounting plates in the enclosure. Brackets are needed when an extra mounting plate is required or when the enclosure is ordered without mounting plate (PE).
- Material:** 3 mm zinc plated steel.
- Pack quantity:** 2 top brackets and 2 bottom sliding brackets with mounting accessories.

Item no.
MPA04



Mounting plate back to back bracket kit, MPBB

- Description:** To mount two mounting plates back to back at any depth within the enclosure's usable space, the position can be adjusted in steps of 25 mm. The space between the mounting plates is less than 10 mm, maximizing the free usable space for customer use.
- Material:** 3 mm zinc plated steel.
- Pack quantity:** 2 top brackets, 4 side brackets, 4 bottom brackets with mounting accessories.



Item no.
MPBB06

Side mounting plate brackets, MPS

- Description:** To mount the standard mounting plate on the side of the enclosure's frame. Provides a mounting surface that is flush with the profiles.
- Material:** 3 mm zinc plated steel.
- Pack quantity:** 4 brackets with mounting accessories.



Item no.
MPS04

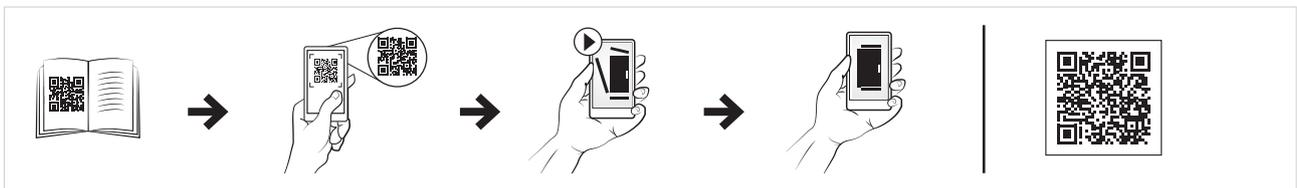

Floor Standing Enclosures

Accessories

Filler plates, MPF

Description: Covers the space between pairs of adjacent mounting plates to provide a continuous working surface, when two enclosures are mounted together.

Material: 2 mm zinc plated steel.

Pack quantity: 1 plate with mounting accessories.



For enclosure	
H	Item no.
1800	MPF1800
2000	MPF2000
2200	MPF2200

For bayed configurations MPD02 must be used along with the fixation brackets supplied with the enclosure and mounting plate. MPA06 must be used if the enclosure comes without fixation brackets. MPF cannot be used with mounting plates if they are installed in the most rear position.

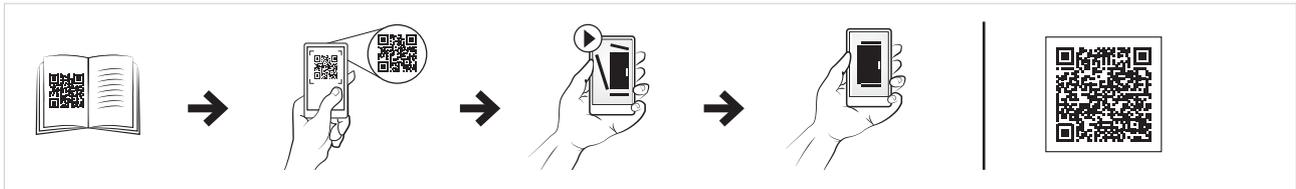

Mounting plate hinge kit, MPH

Description: Allows the mounting plate to be opened up to 105°.

Pack quantity: 1 complete kit with accessories for one mounting plate.

Mounting requirements: Always use in combination with the CB carrier bar.

Item no.
MPH01

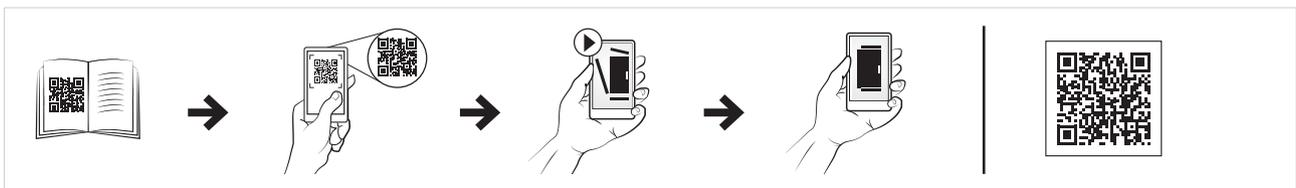
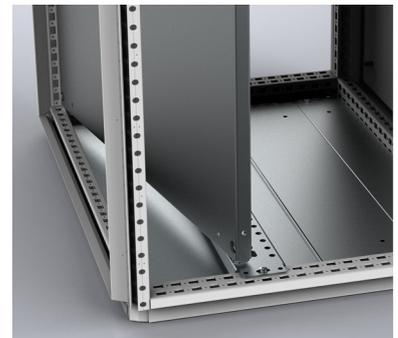

Partial height mounting plates, MPP

- Description:** Mounted directly on the enclosure's frame or onto the click-in profiles (CLPK). Special design of the bracket allows one man assembly. Can be mounted in any height or depth position within the 25 mm hole pattern. Appropriate sizes can also be used on the sides of the enclosure.
- Material:** 3 mm galvanized steel.
- Pack quantity:** 1 plate with mounting accessories.
- Mounting requirements:** Add CLPK for depth adjustment.
- Note:** MPP can be mounted in both directions.

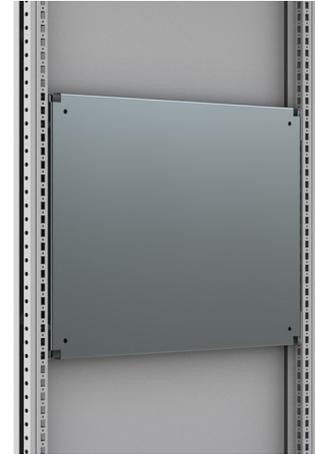

For enclosure		Mounting plate dimensions		Item no.
H/W	W/H	h/w	w/h	
400	400	294	294	MPP0404
400	500	294	394	MPP0405
600	400	494	294	MPP0604
600	500	494	394	MPP0605
600	600	494	494	MPP0606
600	800	494	694	MPP0608
600	1000	494	894	MPP0610
800	400	694	294	MPP0804
800	500	694	394	MPP0805
800	800	694	694	MPP0808
1000	400	894	294	MPP1004
1000	800	894	694	MPP1008
1200	400	1094	294	MPP1204
1200	600	1094	494	MPP1206

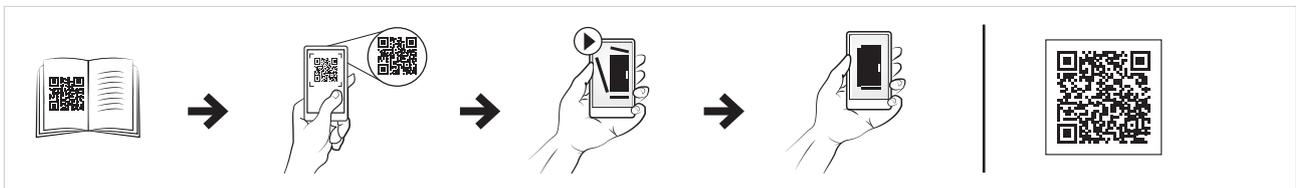

Floor Standing Enclosures

Accessories

Wide mounting plates, MPW

Description: Creates an installation surface over the full width of the enclosure. Easy installation by use of sliding profiles MTS from the side. Nominal width equals the enclosure width. When combining enclosures the MPWs can be connected and slid in as one installation surface. Can not be mounted in the rearmost position.

Material: 3 mm galvanized steel.

Pack quantity: 1 piece with mounting accessories.

Mounting requirements: Add sliding profiles MTS. MPW fits in combinable enclosures only.



For enclosure		
H	W	Item no.
1800	500	MPW1805
1800	600	MPW1806
1800	800	MPW1808
1800	1000	MPW1810
1800	1200	MPW1812
1800	1600	MPW1816*
2000	500	MPW2005
2000	600	MPW2006
2000	800	MPW2008
2000	1000	MPW2010
2000	1200	MPW2012
2000	1600	MPW2016*

* 1600 mm wide mounting plates are supplied as two 800 mm wide mounting plates.

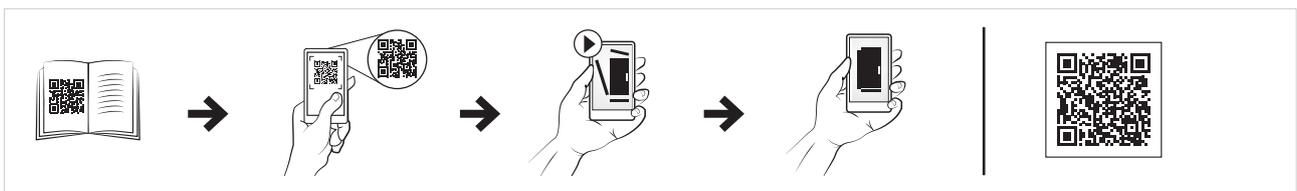

Transversal sliding profiles, MTS

- Description:** To be used when installing a wide mounting plate. Adjustable in depth in steps of 25 mm.
- Material:** 3 mm zinc plated steel.
- Pack quantity:** 2 profiles with mounting accessories.



For enclosure	
W	Item no.
500	MTS500
600	MTS600
800	MTS800
1000	MTS1000
1200	MTS1200
1600	MTS1600

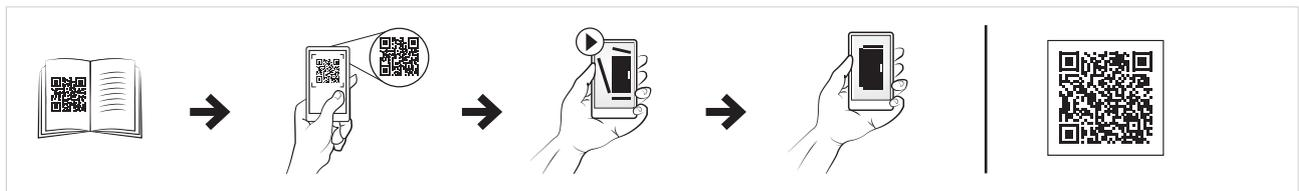

Mounting plate fixing brackets, MPE

- Description:** For extra support of the mounting plate in the middle, in addition to the normal top and bottom fixing.
- Material:** 3 mm zinc plated steel.
- Pack quantity:** 10 pieces.
- Mounting requirements:** Add CMB profiles.

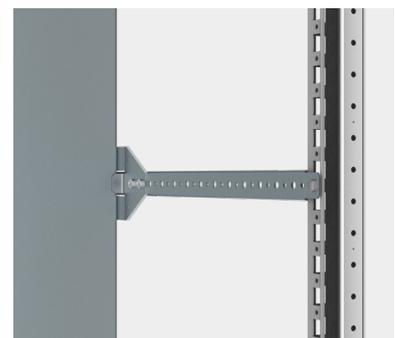

Item no.
MPE10

Floor Standing Enclosures

Accessories

Flush mounting plate fixing brackets, MPEF

Description: For extra fixing of a heavily equipped mounting plate in the far rear position. Mounted directly to the enclosure frame for extra stability. Easy mounting without drilling. Can be fixed from the front even after the mounting plate is already in position. The combination with an MPR profile is advised.

Material: 3 mm zinc plated steel.

Pack quantity: 10 pieces with mounting accessories.

Item no.
MPEF10



Mounting plate reinforcement profiles, MPR

Description: Reinforcing a mounting plate (MP) when heavily equipped. For dampening of vibrations and stabilization. Easy mounting without drilling. In order to achieve maximum damping, fixing of the mounting plate to the profile is advised.

Material: 2 mm galvanized steel.

Pack quantity: 2 profiles with mounting accessories.

For enclosure	
W	Item no.
1000	MPR1000
1200	MPR1200
1600	MPR1600



Mounting plate reinforcement profiles, MPWR

- Description:** Reinforcing a wide mounting plate (MPW) when heavily equipped. For dampening of vibrations and stabilization. Easy mounting without drilling. In order to obtain maximum damping, fixing of the mounting plate to the profile is advised.
- Material:** 2 mm galvanized steel.
- Pack quantity:** 2 profiles with mounting accessories.

For enclosure		Item no.
W		
1000		MPWR1000
1200		MPWR1200



Click-in profiles, CLPK

- Description:** Universal profile for both depth and width fitting on the 25 mm DIN hole pattern of the enclosure's frame or in combination with the CLPF and VB profiles. The 75 mm wide profile is equipped with three rows of holes of which one is turned 90°. This makes it possible to mount the CLPF profiles in both directions. The CLPK can be secured by the use of self tapping screws.
- Material:** 1.5 mm zinc plated steel.
- Pack quantity:** 4 profiles.

For enclosure		
W/D	Max. loading	Item no.
400	2000 N	CLPK400
500	2000 N	CLPK500
600	1600 N	CLPK600
800	1600 N	CLPK800
1000	1200 N	CLPK1000
1200	1200 N	CLPK1200

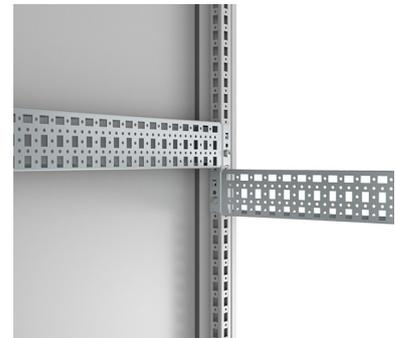

Floor Standing Enclosures

Accessories

Mounting profiles, CLPF

Description:

The CLPF profile system is a 40 mm wide and 25 mm high profile, which can be mounted in all directions on the enclosure's frame. It can also be used in combination with the CLPK and the VB profiles. By turning the profile it can be used as a standard CP20/40 profile in combination with GLM 40/6 sliding nut, to mount installation material which needs adjusting in depth. The profiles, when mounted onto the enclosure's frame are flush with the enclosure's profiles. Two rows of hole patterns for cage nut fixing and self tapping screws are provided. For 90 mm wide profiles two profiles can be mounted next to each other.

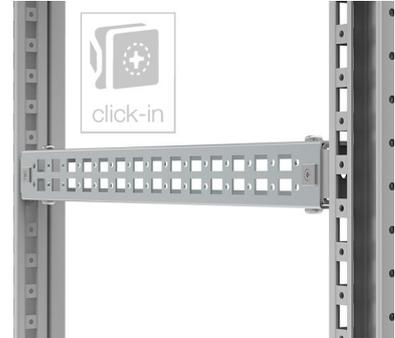

Material:

Zinc plated steel.

Pack quantity:

4 profiles including snap-line for fixing.

For enclosure				
H/W	W/D	Max. loading Horizontal C	Max. loading Horizontal	Item no.
400	400	800 N	1000 N	CLPF400
500	500	800 N	1000 N	CLPF500
600	600	800 N	1000 N	CLPF600
800	800	800 N	1000 N	CLPF800
1000	1000	800 N	1000 N	CLPF1000
1800	1800	Only vertical loads allowed	Only vertical loads allowed	CLPF1800
2000	2000	Only vertical loads allowed	Only vertical loads allowed	CLPF2000
2200	2200	Only vertical loads allowed	Only vertical loads allowed	CLPF2200

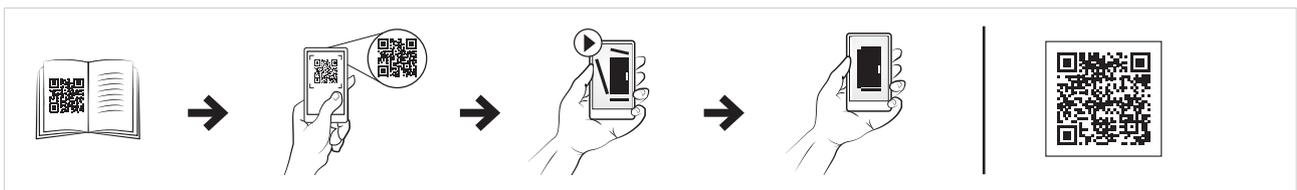

Side mounting bars, CMB

Description: For fixing cables, cable guides, etc, in the depth or the width of an enclosure.

Material: 2 mm zinc plated steel.

Pack quantity: 20 profiles with mounting accessories.

For enclosure	
W/D	Item no.
400	CMB402
500	CMB502
600	CMB602
800	CMB802



Height profiles, HP

Description: Vertical profiles with 25 mm hole pattern, to support DIN rails and appropriate telequick mounting plates. Adjustable in depth in steps of 25 mm.

Material: 2 mm zinc plated steel.

Pack quantity: 2 profiles with mounting accessories.

For enclosure	
H	Item no.
1800	HP1800
2000	HP2000
2200	HP2200

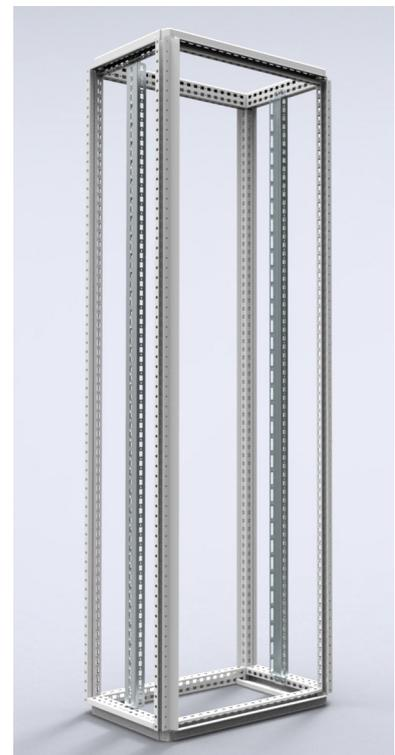

Floor Standing Enclosures

Accessories

Cage nuts, CNM

Description: Cage nuts designed for universal use on the enclosure frame profiles and the profiles system.

Pack quantity: 50 pieces.

Thread	Item no.
M6	CNM615
M8	CNM815



Screws for clip-on cage nuts, CNS

Description: Socket head screws M6x12 and M8x12 for clip-on cage nuts.

Pack quantity: 250 pieces.

Thread	Item no.
M6	CNS612
M8	CNS812



Extrude-tite screws, CNT

Description: Torx extrude-tite screws for fitting accessories, click in profiles, earthing etc.

Pack quantity: 250 pieces.

Thread	Item no.
M5	CNT05
M6	CNT06



Extrude-tite screws for stainless steel profiles, CNTS

Description: To be used in the DIN pattern of round holes on the stainless steel enclosure frame. Torx extrude-tite screws for fitting accessories.

Pack quantity: 250 pieces.

Thread	Item no.
M5	CNTS05
M6	CNTS06



Carrier bars, CB

Description: Used for heavy equipment, such as transformers, fitted in the bottom of the enclosure.

Material: 3 mm zinc plated steel.

Pack quantity: 1 pair with mounting accessories.

For enclosure		
W/D	Max. loading	Item no.
400	2500 N	CB400
500	2100 N	CB500
600	1800 N	CB600
800	1300 N	CB800

The maximum load is indicated per bar.



Floor Standing Enclosures

Accessories

Heavy duty carrier bars, CBU

Description: Heavy duty carrier bar for mounting heavy components e.g. transformers. Supplied with T-shaped sliding bolts and equipped with slotted holes for mounting in any position, both in width and depth of the enclosure.

Material: 2.5 mm zinc plated steel.

Pack quantity: 1 pair with mounting accessories and 4 T-shaped sliding bolts.

For enclosure		
W/D	Max. loading	Item no.
400	3000 N	CBU400
500	3000 N	CBU500
600	3000 N	CBU600
800	2250 N	CBU800
1000	1800 N	CBU1000
1200	1500 N	CBU1200

The maximum load is indicated per bar.

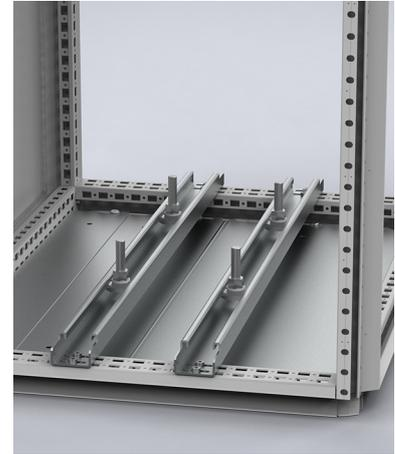

Adjustment profiles, APK

Description: Width profiles which allows for continuous adjustment of fixation cage nuts for components in height, depth and width. Panel builders can then fix any component in the desired position without machining.

Material: 2,5 mm galvanized steel.

Pack quantity: 2 pairs.

Requirements: To be assembled on CLPF depth profiles.

For enclosure	
W	Item no.
600	APK600
800	APK800



Full Height Swing Frames, ESFC

- Description:** Full height swing frame for 19" components allowing left and right hand opening. Can be used in steel, combinable and compact enclosures. Hinges designed to give extra build-in depth. Adjustable top hinge for square mounting of the swing frame. Rigid W-shaped frame profile for heavy equipment. Zinc plated 19" vertical profiles for direct earthing of the mounted components. Standard equipped with 130° hinges (180° hinges not applicable for 600 mm wide enclosures). Can also be mounted on the side of 600 mm deep floor standing enclosures. For steel, combinable enclosures use transversal support bars ESFB in combination with VBD if required. Adjustable in depth by steps of 12.5 mm.
- Maximum load:** 1800N, supplied with a self positioning device.
- Lock:** Two 3 mm double-bit locks.
- Material:** 19" vertical profiles 2 mm zinc plated steel. Frame: vertical profiles 2 mm and horizontal profiles 3 mm.
- Pack quantity:** 1 swing frame with hinges.
- Mounting requirements:** ESFC for 600 mm, 800 mm, 1000 mm, 1200 mm wide steel, combinable enclosures. Add ESFB for mounting in a steel, combinable enclosure.



For enclosure					
H	U	H1	H2	H3	Item no.
1800	36	1603	1667	1737	ESFC366
2000	40	1781	1845	1915	ESFC406
2200	45	2003	2067	2137	ESFC456

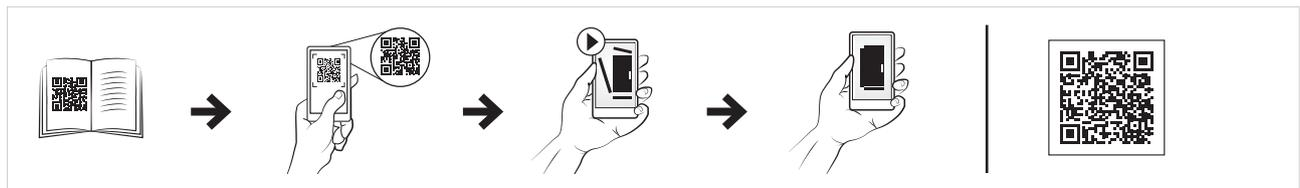

Floor Standing Enclosures

Accessories

Swing Frame middle mounted, ESFM

- Description:** Full height swing frame for 19" components allowing left and right hand opening with grip over the full height. Can be used in steel, combinable and compact enclosures. Hinges designed to give extra build-in depth. Adjustable top hinge for square mounting of the swing frame. Rigid W-shaped frame profile for heavy equipment. Zinc plated 19" vertical profiles for direct earthing of the mounted components. Full access to the enclosure aperture can be acquired by the standard fitted 180° hinges. For mounting use transversal support bars ESFB. Depth support and easy cable routing is achieved with depth mounting plate SFMP. Adjustable in depth by steps of 12.5 mm.
- Maximum load:** 1800 N, supplied with a self-positioning device.
- Lock:** Double-bit 3 mm espagnolette (other lock options possible).
- Material:** 19" vertical profiles 2 mm zinc plated steel. Frame: vertical profiles 2 mm and horizontal profiles 3 mm.
- Finish:** RAL 7035 structured powder coating.
- Pack quantity:** 1 swing frame with 180° hinges.
- Mounting requirements:** ESFM for 800 mm and 1000 mm wide steel, combinable enclosures. Add ESFB for mounting in a steel, combinable enclosure.



For enclosure					
H	U	H1	H2	H3	Item no.
1800	36	1603	1667	1737	ESFM368
2000	40	1781	1845	1915	ESFM408
2200	45	2003	2067	2137	ESFM458

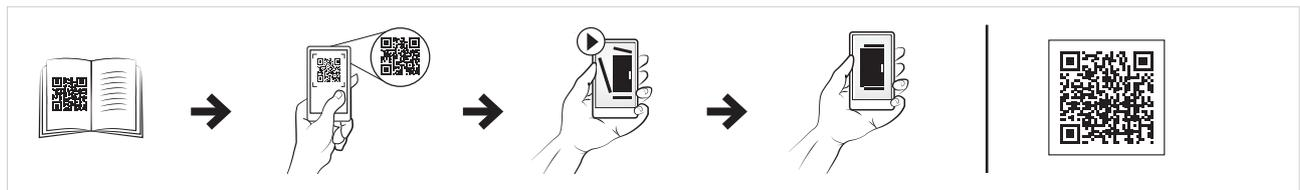

Swing Frame side mounted, ESFS

- Description:** Full height swing frame for 19" components allowing left and right hand opening with grip over the full height. Can be used in steel, combinable and compact enclosures. Hinges designed to give extra build-in depth. Adjustable top hinge for square mounting of the swing frame. Rigid W-shaped frame profile for heavy equipment. Zinc plated 19" vertical profiles for direct earthing of the mounted components. Standard equipped with 130° hinges. Full access to the enclosure's aperture can be acquired by use of 180° hinges ESFH180. For mounting use transversal support bars ESFB. Depth support and easy cable routing is achieved with depth mounting plate SFMP. Adjustable in depth by steps of 12.5 mm.
- Maximum load:** 1800 N, supplied with a self-positioning device.
- Lock:** Double-bit 3 mm espagnolette (other lock options possible).
- Material:** 19" vertical profiles 2 mm zinc plated steel. Frame: vertical profiles 2 mm and horizontal profiles 3 mm.
- Finish:** RAL 7035 structured powder coating.
- Pack quantity:** 1 swing frame with hinges.
- Mounting requirements:** ESFS for 800 mm, 1000 mm wide steel, combinable enclosures. Add ESFB for mounting in a steel, combinable enclosure.



For enclosure					
H	U	H1	H2	H3	Item no.
1800	36	1603	1667	1737	ESFS368
2000	40	1781	1845	1915	ESFS408
2200	45	2003	2067	2137	ESFS458

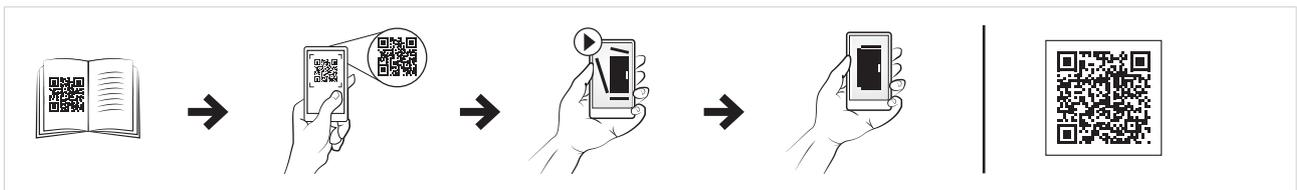

Floor Standing Enclosures

Accessories

Swing Frame transversal support bars, ESFB

Description: For full height mounting of swing frames in steel, combinable and compact enclosures. When partial height mounting is required use the ESFB in combination with CLPK or CLPF. The swing frames can be mounted both left and right hand opening. One man installation with integrated safety catch which holds the swing frame in the mounting position (130° hinge). Pre-punched holes for mounting a door switch (DSW01) is provided in the top swing frame support with W>600mm and with ESFS or ESFM swing frames.

Material: 3 mm zinc plated steel.

Mounting requirements: Support bars (ESFB) 600 mm wide can also be mounted directly into a 1200 mm wide enclosure by means of a VBD. Support bars (ESFB) 800 mm wide can also be mounted directly in 1600 mm wide enclosures.

Pack quantity: One complete kit for a swing frame.

For enclosure	
W	Item no.
600	ESFB06
800	ESFB08
1000	ESFB10
1200	ESFB12

To mount 2 x ESFC swing frames, an additional mounting kit ESFB12XKIT is required.



Swing frame door stop, ESFD

Description: To enable locking of the swing frame in the open position. Mounted directly onto the swing frame and support bars. The door stop can be easily disconnected to provide full opening of the swing frame.

Material: Zinc plated steel.

Pack quantity: 1 piece with mounting accessories.

Opening degree	Item no.
130°	ESFD130
180°	ESFD180



Swing Frame hinges 180°, ESFH

Description:	Allows the swing frame to be opened up to 180°. Adjustable top hinge for square mounting of the swing frame. Smart hinge point position giving maximum build-in depth.
Material:	Zinc plated steel.
Pack quantity:	1 set.
Mounting requirements:	To be used in combination with ESFS mounted in 800 mm, 1000 mm and 1200 mm wide enclosures.

Item no.
ESFH180



Swing Frame chassis support, SFSU

Description:	To add in-depth support and relieve pressure on heavy chassis applications.
Material:	2 mm zinc plated steel.
Pack quantity:	1 pair with mounting accessories.
Mounting requirements:	For full height swing frames the SFMP can be added for more in-depth support and easy cable routing. Mounted directly to the back of the swing frame or to the Swing Frame mounting plate SFMP.

Item no.
SFSU02



Floor Standing Enclosures

Accessories

Partial height swing frames, SFCP

- Description:** Partial height swing frame for 19"-components allowing left or right hand opening. Can be used in wall mounted, steel enclosures, and floor standing, combinable and compact, steel enclosures. Rigid S-shaped frame profile equipped with 19" hole pattern in front and back. Zinc plated frame for direct earthing of the mounted components. Standard opening angle 125°-155°. Mounting in wall mounted, steel enclosures requires the SFBP transversal support in combination with the AVB. Mounting in floor standing steel combinable enclosures requires the SFBP transversal support.
- Lock:** 1 double-bit 3 mm lock.
- Material:** 2 mm zinc plated steel.
- Pack quantity:** 1 swing frame with hinges.
- Mounting requirements:** Mounting in wall mounted, steel enclosures requires the SFBP transversal support in combination with the AVB. Mounting in floor standing steel combinable enclosures requires the SFBP transversal support. Adjustable in depth in combination with CLPK profiles.



For enclosure			
H	U	Max. loading	Item no.
600	3	150 N	SFCP036
600	6	300 N	SFCP066
600	10	500 N	SFCP106
800	12	500 N	SFCP126
800	15	500 N	SFCP156
1000	19	500 N	SFCP196
1200	24	500 N	SFCP246

Partial SF transversal brackets, SFBP-B

- Description:** Enables partial height swing frames to be mounted in floor standing, combinable and compact, steel enclosures enclosures with full access to the enclosure's aperture. The swing frame can be mounted to allow both left and right hand opening.
- Material:** 3 mm zinc plated steel.
- Pack quantity:** 1 complete kit for one swing frame.
- Mounting requirements:** The SFBP can be used in double door enclosures by means of the VB/CDV divider profile. For depth adjustment use CLPK profiles



Item no.
SFBP03

Partial SF transversal support bars, SFBP

- Description:** Enables partial height swing frames to be mounted in wall mounted, steel enclosures, and floor standing, combinable, steel enclosures. The swing frames can be mounted to allow both left and right hand opening.
- Material:** 3 mm zinc plated steel.
- Pack quantity:** 1 complete kit including mounting brackets for one swing frame.
- Mounting requirements:** For wall mounted, steel enclosures, use in combination with the AVB profiles. For floor standing enclosures, it can be mounted directly to the enclosure frame or adjustable in depth, in steps of 25 mm, by means of the CLPK.



For enclosure		
W		Item no.
600		SFBP600
800		SFBP800

19" Mounting profiles, CIP

- Description:** Full height mounting profiles to achieve 482.6 mm (19") mounting requirements on all sides. Fully adjustable in depth.
- Material:** 2 mm zinc plated steel.
- Pack quantity:** 1 pair.
- Mounting requirements:** To be used in conjunction with CIB or CID profiles. For partial height mounting the CIWR is required.

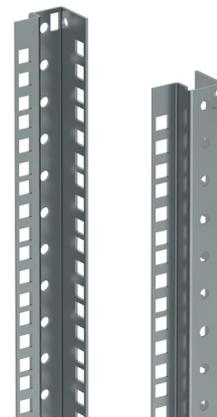

For enclosure		
H	U	Item no.
1000	20	CIP20
1200	24	CIP24
1600	33	CIP33
1800	38	CIP38
2000	42	CIP42
2200	47	CIP47

Floor Standing Enclosures

Accessories

Profiles for 19" profiles fixing, CIB

Description: For fitting 19" vertical profiles CIP/CIPD in 600 mm and 800 mm wide enclosures. Fully adjustable in depth.

Material: 3 mm zinc plated steel.

Pack quantity: 2 profiles with mounting accessories.

For enclosure		
W		Item no.
600		CIB600
800		CIB800

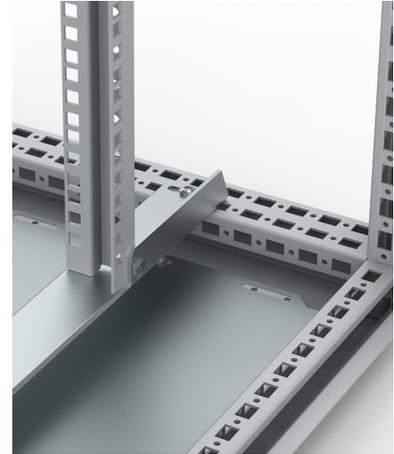

Profiles for 19" profiles asymmetric fixing, CID

Description: For fitting asymmetric 19" mounting profiles CIP/CIPD in 800 mm or wider enclosures. Fully adjustable in depth. Especially suited when heavier (active) components will be fitted.

Material: 3 mm zinc plated steel.

Pack quantity: 4 profiles with mounting accessories.

For enclosure		
W	D	Item no.
800/1000	600	CID600
800/1000	800	CID800



19" Mounting profiles, CIPD

- Description:** Side universal 19" punching. For additional internal support.
- Material:** 2 mm zinc plated steel.
- Pack quantity:** 1 pair.
- Mounting requirements:** To be used in conjunction with CIB or CID profiles. For partial height mounting the CIWR is required.

For enclosure		
H	U	Item no.
1800	38	CIPD38
2000	42	CIPD42
2200	47	CIPD47

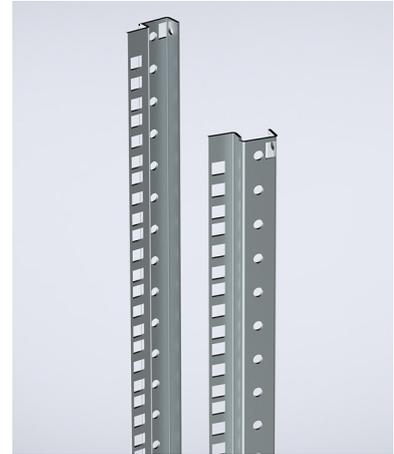

Brackets for 19" partial height mounting profiles, CIC

- Description:** For fixing 19" vertical profiles CIPP in 800 mm wide enclosures. Adjustable in depth in steps of 25 mm by using the CLPK click-in profiles.
- Material:** 3 mm zinc plated steel.
- Pack quantity:** 4 brackets with mounting accessories.

Item no.
CIC04



Floor Standing Enclosures

Accessories

19" partial height mounting profiles, CIPP

- Description:** Partial height 19" vertical profiles to achieve 482.6 mm (19") mounting requirements on all sides. Adjustable in depth in steps of 25 mm using the CLPK click-in profiles.
- Material:** 2 mm zinc plated steel.
- Pack quantity:** 2 pieces with mounting accessories.
- Mounting requirements:** To be used with brackets CIC in 800 mm wide enclosures.

U	Item no.
6	CIPP06
9	CIPP09
10	CIPP10
11	CIPP11
13	CIPP13
15	CIPP15
18	CIPP18



19" Width reducers, CIWR

- Description:** Used to obtain 19" mounting facilities in 800 mm wide enclosures. Allows the mounting of CIP/CIPP profiles on partial or full height at any depth.
- Material:** 2 mm zinc plated steel.
- Maximum load:** Maximum supported weight is 5000N on 2 pair of CIWR and 8000N on 3 pair of CIWR.
- Pack quantity:** 1 pair with mounting accessories.

For enclosure		Mounting plate dimensions	
W	D	w	Item no.
800	600	19"	CIWR8196
800	800	19"	CIWR8198



Front Phillips screws, CHS

Description:	For the mounting of front closing panels (PAC/PAL) or shelves on to the 19" profiles. To be used in combination with plastic washer PW6.
Length:	16 mm.
Pack quantity:	50 pieces.

Thread	Item no.
M6	CHS616



Front frame cover, FFC

Description:	To cover the framework around the door aperture on 600 mm wide data-telecom enclosures, when a door is not fitted.
Material:	1.75 mm steel plate.
Finish:	RAL 7035 structured powder coating.
Pack quantity:	1 set with mounting accessories.

Enclosure dimensions		Height U	Item no.
H	W		
2000	600	42	FFC2006R5



Plastic washers, PW

Description:	Plastic washer for the M6 front Phillips screws (CHS). To prevent damaging the front of the patch panels.
Pack quantity:	50 pieces.

Item no.
PW6



Floor Standing Enclosures

Accessories

Cage nuts, CN

Description: For 2 mm steel thickness.

Pack quantity: 50 pieces.

Thread	Item no.
M6	CN6

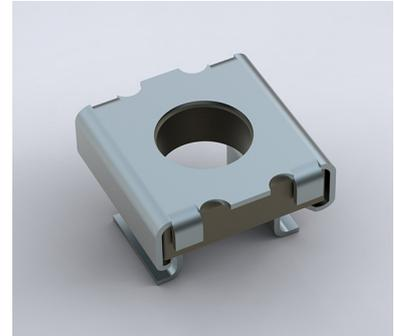

Friction slide, L

Description: To support heavy components which are only fitted to the front. Mounted between two 19" profiles. Version fixed with 2 screws per profile, and version with click-in fixation.

Material: Click-in version 1.5 mm and mounted version 3 mm zinc plated steel.

Pack quantity: 1 pair with fixing material.

Length	Type	Max. loading	Item no.
279	screwed	980 N	L279
406	screwed	980 N	L406
406	click-in	490 N	L406C
470	screwed	980 N	L470
470	click-in	490 N	L470C
597	screwed	980 N	L597
700	screwed	980 N	L700



1U Keyboard tray, DKB

Description: For the installation of narrow 19" wide keyboard for PC, server or control system. Mounted directly to existing 19-Inch profiles in front and rear.

Material: 1.25 mm steel.

Finish: RAL 7035.

Pack quantity: 1 keyboard tray with telescopic rails and fixing accessories.

H	W	D	U	Item no.
32	406	182	1	DKB02



19" shelf, VSF

- Description:** Maximum loading capacity when mounted directly onto the 19" profiles, front and rear. Ventilation openings.
- Material:** 1.5 mm steel.
- Finish:** RAL 7035.
- Pack quantity:** 1 shelf with mounting material.

For enclosure			
W	D	Max. loading	Item no.
19"	404	1200 N	VSF1406
19"	468	1200 N	VSF1470
19"	595	1200 N	VSF1597



19" telescopic shelf, VTS

- Description:** Mounted directly onto the 19" profiles, front and rear, 1U high. Ventilation openings.
- Material:** 1 mm steel.
- Finish:** RAL 7035.
- Pack quantity:** 1 shelf and 2 quick mounting 3-member slides, front handle and mounting material.

For enclosure			
W	D	Max. loading	Item no.
19"	500	500 N	VTS1470
19"	600	500 N	VTS1597



Floor Standing Enclosures

Accessories

Painted steel front panels, PAC

Description: Plain 19" front panel.

Material: 3 mm steel.

Finish: RAL 7035.

Pack quantity: 1 piece.

Height U	W	h	Item no.
1	19"	44.45	PAC01
2	19"	88.90	PAC02
3	19"	133.35	PAC03
4	19"	177.80	PAC04
6	19"	266.70	PAC06

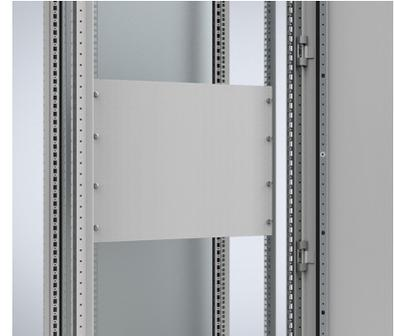

Ventilated shelves, SHC

Description: Mounted directly onto the enclosure's frame.

Material: 2 mm zinc plated steel.

Maximum load: 500 N.

Pack quantity: 1 shelf with mounting accessories.

For enclosure		Mounting plate dimensions		Item no.
W	D	w	d	
600	600	509	555	SHC0606
600	800	509	755	SHC0608
800	600	709	555	SHC0806
800	800	709	755	SHC0808
800	900	709	855	SHC0809



Telescopic ventilated shelf, SHT

- Description:** For easy access to installed equipment. Mounted directly to the enclosure's frame. Partial depth mounting is an option. Possibility to take the shelf out of the slides even after mounting into the enclosure. Reversed and side mounting possible.
- Material:** 2 mm zinc plated steel.
- Maximum load:** 500 N.
- Pack quantity:** 1 ventilated shelf and 1 pair of telescopic slides with mounting accessories.
- Mounting requirements:** Add SHTP profiles for full/partial depth installation to the enclosure's frame.



For enclosure		Shelf dimensions		Item no.
W	D	w	d	
600	600	460	550	SHT0606
600	800	460	750	SHT0608
800	600	660	550	SHT0806
800	800	660	750	SHT0808

Telescopic shelf HD, SHTH

- Description:** For easy access to installed equipment. Mounted directly to the enclosure's frame with integrated handle. Reversed mounting possible.
- Material:** 2 mm zinc plated steel.
- Maximum load:** 1000 N.
- Pack quantity:** 1 ventilated shelf and 1 pair of telescopic slides with mounting accessories.



For enclosure		
W	D	Item no.
600	600	SHTH0606
600	800	SHTH0608
800	600	SHTH0806
800	800	SHTH0808

Floor Standing Enclosures

Accessories

Seismic bracket kit, SBK

- Material:** Side bars: 4 mm galvanized steel. Brackets: 3 mm galvanized steel.
- Pack quantity:** 1 seismic bracket with mounting material.
- Mounting requirements:** Depth mounted CLPK Click in profile and width mounted CB carrier bar at the top and bottom to comply with the seismic tests.

For enclosure			
H	W	D	Item no.
2000	600	400	SBK20064
2000	600	600	SBK20066
2000	800	600	SBK20086
2000	800	800	SBK20088

*Other dimensions are available upon request.



Mounting profiles for SHT, SHTP

- Description:** Profiles for partial and full depth mounting of the telescopic shelf SHT. Makes possible to mount a 600 mm deep SHT in a 800 mm deep enclosure. Fixed directly to the enclosure's frame. Fully adjustable in height in steps of 12.5 mm.
- Material:** 1.5 mm zinc plated steel.
- Pack quantity:** 2 profiles with mounting accessories.

For enclosure	
D	Item no.
600	SHTP600
800	SHTP800





Front/rear Plinths, PF

- Description:** Front and rear plinth sections. For cabling without any restrictions and in accordance with the VDE 0113 standard. The plinth consists of four corner pieces with removable front covers. The side panels PS are to be ordered separately. Produced in 100 mm and 200 mm heights. 200 mm high plinths are delivered with a rear cover for cabling that consists of two removable panels 100 mm high. The front cover is a one piece panel of 200 mm high. All panels have double returns on each side for added strength.
- Material:** Corner pieces in 2 mm and panels in 1.5 mm mild steel.
- Finish:** RAL 7022 structured powder coating.
- Pack quantity:** 1 set of 4 corner pieces including covers. Front and rear panel (2 rear panels for 200 mm high plinths) with mounting accessories. Mounting accessories for side panels PS or transversal profiles PCP.
- Mounting requirements:** Add the side panels PS for a complete plinth. When combining enclosures it is recommended to add transversal panels PCP for cable duct support and extra rigidity.



For enclosure		
H	W	Item no.
100	400	PF1040
100	500	PF1050
100	600	PF1060
100	800	PF1080
100	1000	PF1100
100	1200	PF1120
200	400	PF2040
200	500	PF2050
200	600	PF2060
200	800	PF2080
200	1000	PF2100
200	1200	PF2120

For enclosures 1600 mm wide use 2 x 800 mm wide plinth.

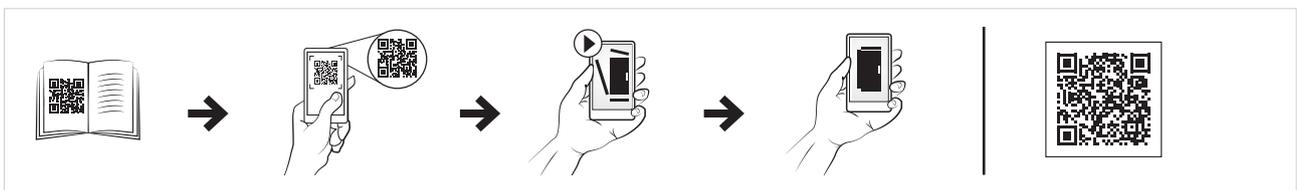

Floor Standing Enclosures

Accessories

Ventilated front/rear plinths, PV

Description: Front and rear plinth sections with ventilated panels. Recommended to be used in combination with the ventilated bottom plate CVB. For cabling without any restrictions and in accordance with the VDE 0113 standard. The plinth consists of four corner pieces with removable front covers. All panels have double returns for added strength. Only available in height of 100 mm.

Material: Corner pieces in 2 mm and panels in 1.5 mm mild steel.

Finish: RAL 7022 structured powder coating.

Pack quantity: 1 set of 4 corner pieces including covers. Front and rear panel with mounting accessories for side panels PS or transversal profiles PCP.

Mounting requirements: Add the side panels PS for a complete plinth. When combining enclosures it is recommended to add transversal panels PCP for cable duct support and extra rigidity. Use ventilated bottom plates CVB to get better enclosure ventilation.



For enclosure	
W	Item no.
400	PV1040
600	PV1060
800	PV1080
1000	PV1100
1200	PV1120



Plinth combining profiles, PCP

Description: Acts as a stabiliser when cabling is routed between bayed enclosures. With the PCP, plinths can be combined and fixed to the floor before the enclosures are mounted on them. The PCP can be used when cables have to go under the enclosure. For 200 mm high plinths, the PCP can be mounted in three different heights, top, middle or bottom. The hole pattern for cage nuts and M5x10 screws, allows accessories to be mounted.

Material: 2 mm steel plate.

Finish: RAL 7022 structured powder coating.

Pack quantity: 2 profiles with mounting accessories.



For enclosure	
D	Item no.
400	PCP04
500	PCP05
600	PCP06
800	PCP08
1000	PCP10

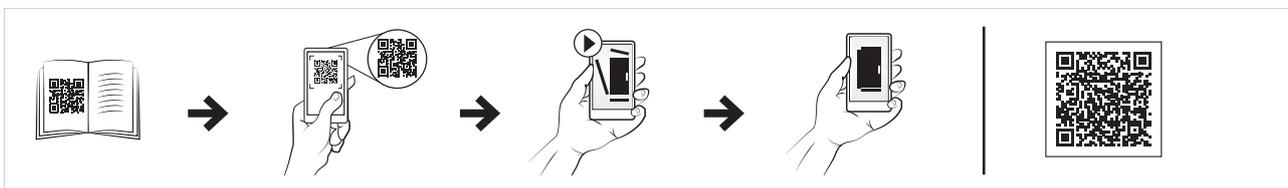

Floor Standing Enclosures

Accessories

Side plinths, PS

Description: Side panels to cover the openings in the sides of the PF/PV plinths. Double folded panels for maximum strength. Compatible with combinable and semi-compact enclosure ranges.

Material: 1.5 mm steel plate.

Finish: RAL 7022 structured powder coating.

Pack quantity: 2 panels. Mounting accessories included with PF/PV.

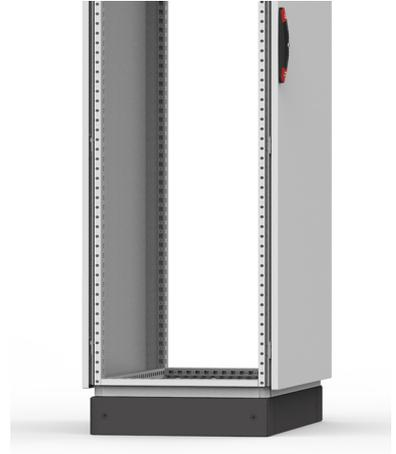

For enclosure		
H	D	Item no.
100	300	PS1030
100	400	PS1040
100	500	PS1050
100	600	PS1060
100	800	PS1080
100	1000	PS1100
200	300	PS2030
200	400	PS2040
200	500	PS2050
200	600	PS2060
200	800	PS2080
200	1000	PS2100

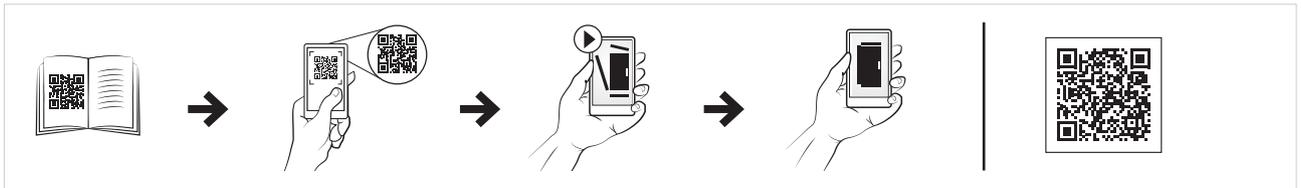



Front/Rear plinth, stainless steel, PFS

- Description:** Front and rear plinth sections. For cabling without any restrictions and in accordance with the VDE 0113 standard. The plinth consists of four corner pieces with removable front covers. The side panels PSS are to be ordered separately. Produced in 100 mm and 200 mm heights. 200 mm high plinths are delivered with a rear cover for cabling that consists of two removable panels 100 mm high. The front cover is a one piece panel of 200 mm high. All panels have double returns on each panel for added strength.
- Material:** AISI 304 / AISI 316L pre-grained stainless steel. Corners 2 mm and panels 1.5 mm.
- Finish:** 400 pre-grained stainless steel.
- Pack quantity:** 1x front plinth and 1x rear plinth with mounting accessories.
- Mounting requirements:** Add the side panels PSS for a complete plinth.



For enclosure		
H	W	Item no.
100	600	PFS1060
100	800	PFS1080
100	1200	PFS1120

For enclosures 1600 mm wide use 2 x 800 mm wide plinth.

Leveling feet, LF

- Description:** Adjustable feet for leveling enclosures placed on uneven ground. Mounted directly to the enclosure's frame. Adjustment stroke: 30 mm.
- Maximum load:** 3000 N per foot.
- Pack quantity:** 4 pieces with mounting accessories.

Item no.
LF430



Floor Standing Enclosures

Accessories

Side plinths, PSS

Description: Side panels to cover the openings in the sides of the PFS plinth. Double folded panels for maximum strength. Compatible with combinable and compact stainless steel floor standing ranges.

Material: AISI 304 / AISI 316L pre-grained stainless steel. Panels: 1.5 mm.

Finish: 400 pre-grained stainless steel.

Pack quantity: 2 panels. Mounting accessories included with PFS.

For enclosure		
H	D	Item no.
100	500	PSS1050
100	600	PSS1060



Wall fixing brackets, CCB

Description: To fix the enclosure to the wall by using M12 screws on the top of the enclosure. Prevents the enclosure from tipping over e.g. on board ships. Compatible with combinable and compact mild steel floor standing enclosure ranges.

Material: 3 mm zinc plated steel.

Pack quantity: 2 pieces.

Item no.
CCB02



Casters, LCR

- Description:** For easy transportation of an (equipped) enclosure. Can be mounted directly to the enclosure's frame or underneath the plinths (PF/PV) with the provided mounting brackets. Raises the enclosure by 70 mm.
- Maximum load:** 2800 N (Moving) or 5600 N (Static) per kit.
- Pack quantity:** 4 pieces with mounting accessories.



Type	Item no.
4 casters without brakes	LCR470
2 casters with and 2 without brakes	LCR471
4 casters with brakes	LCR472

Glazed doors, DNG

- Description:** Glazed door with fitted clear safety glass to view the inside of the enclosure. Equipped with double-bit 3 mm lock system and door frame. Allows all options of the locking program. Compatible with combinable and compact enclosure ranges.
- Material:** Frame: 2 mm steel plate. Viewing area: 4 mm clear safety glass.
- Finish:** RAL 7035 structured powder coating.
- Protection:** Complies with IP 55 | TYPE 12 | IK 07.
- Pack quantity:** 1 piece.
- Mounting requirements:** Use hinge kit DNMK01 if no door was fitted previously.



For enclosure		Viewing area		Item no.
H	W	h	w	
1800	600	1576	415	DNG1806R5
1800	800	1576	615	DNG1808R5
2000	600	1776	415	DNG2006R5
2000	800	1776	615	DNG2008R5
2000	1000	1776	815	DNG2010R5
2200	600	1976	415	DNG2206R5
2200	800	1976	615	DNG2208R5

Floor Standing Enclosures

Accessories

Plain doors, DN

Description:	Standard door equipped with double-bit 3 mm lock system and door frame. Door accessory kit DNMK (hinges, rod catches) to be ordered separately. Allows all the options of the locking program and 180° hinges. Compatible with combinable and compact enclosure ranges.
Material:	2 mm steel plate.
Maximum load:	800 N.
Finish:	RAL 7035 structured powder coating.
Mounting requirements:	Use hinge kit DNMK if no door was fitted previously.
Pack quantity:	1 piece.

Plain door

H	W	Item no.
1800	600	DN1806R5
1800	800	DN1808R5
1800	1000	DN1810R5
2000	500	DN2005R5
2000	600	DN2006R5
2000	800	DN2008R5
2000	1000	DN2010R5
2200	600	DN2206R5
2200	800	DN2208R5

Right door

H	W	Item no.
1800	500	DN1805RR5
1800	600	DN1806RR5
1800	800	DN1808RR5
2000	400	DN2004RR5
2000	500	DN2005RR5
2000	600	DN2006RR5
2000	800	DN2008RR5
2200	500	DN2205RR5
2200	600	DN2206RR5

Left door

H	W	Item no.
1800	500	DN1805LR5
1800	600	DN1806LR5
1800	800	DN1808LR5
2000	400	DN2004LR5
2000	500	DN2005LR5
2000	600	DN2006LR5
2000	800	DN2008LR5
2200	500	DN2205LR5
2200	600	DN2206LR5



Door hinges 180°, DHN

Description:	Adjustable door hinges which allows the door to open 180°. Machining is required.
Material:	Die-cast alloy.
Finish:	Structured black.
Maximum load:	800 N (per kit).
Pack quantity:	4 hinges with mounting accessories.



Item no.
DHN180N

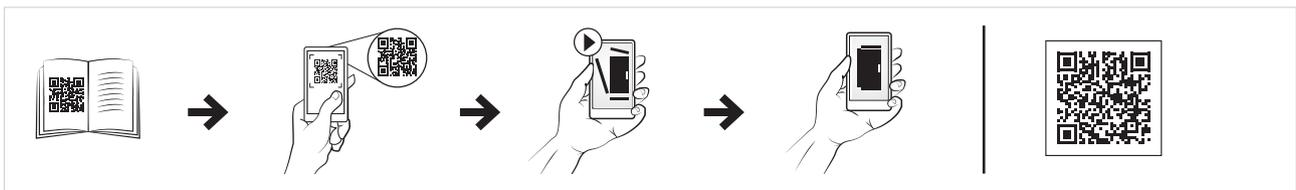

Door mounting kits, DNMK

Description:	Door mounting kit for mild steel floor standing enclosures. Required when fitting a door. Only needed when there was no door mounted previously.
Pack quantity:	1 complete kit with hinges, rod catches and mounting accessories.

Description	Item no.
for single door enclosures	DNMK01
for double door enclosures	DNMK02



Floor Standing Enclosures

Accessories

Inner doors, DI

Description: Inner door provides a hinged mounting surface for equipment behind a standard or glazed front door. A mounting space of 80 mm, is available between the doors when the inner door is in the most forward position. Can be adjusted in depth by steps of 25 mm. The mounting plate remains usable behind the inner door. The door is equipped with two double-bit 3 mm locks.

Material: 1.5 mm mild steel.

Finish: RAL 7035 structured powder coating.

Pack quantity: 1 door with mounting accessories.

For enclosure		
H	W	Item no.
1800	600	DI1806R5
1800	800	DI1808R5
2000	600	DI2006R5
2000	800	DI2008R5
2200	600	DI2206R5
2200	800	DI2208R5

Other sizes available on request.



Side doors, DNS

Description: Instead of the side panel SPM. For easy access to the equipment inside the enclosure or when enclosures are mounted rear to rear. Equipped with standard double-bit 3 mm lock which makes all lock options possible. Door frame optional.

Material: 2 mm steel plate.

Finish: RAL 7035 structured powder coating.

Protection: Complies with IP 55 | TYPE 12 | IK 10.

Pack quantity: 1 door including mounting frame.

H	W	Item no.
1800	500	DNS1805R5
1800	600	DNS1806R5
2000	500	DNS2005R5
2000	600	DNS2006R5



Door plastic support, DPSL

Description: Helps to centre the door in case of an uneven floor, as well as allowing easier closing and positioning when a heavy load is mounted (cooling units, etc). Mounted directly to the door frame on the bottom and top of the door. Highly recommended when fitting loads from 30 kg on door.

Pack quantity: 2 plastic supports with mounting accessories.

Item no.
DPSL01



Door stop, DSTP

Description: To lock an open door in position. Mounted directly to the door frame and on the enclosure profile. Allows the enclosure door to be opened up to 110°.

Pack quantity: 1 piece with mounting accessories.

Material	Item no.
Zinc plated	DSTP02

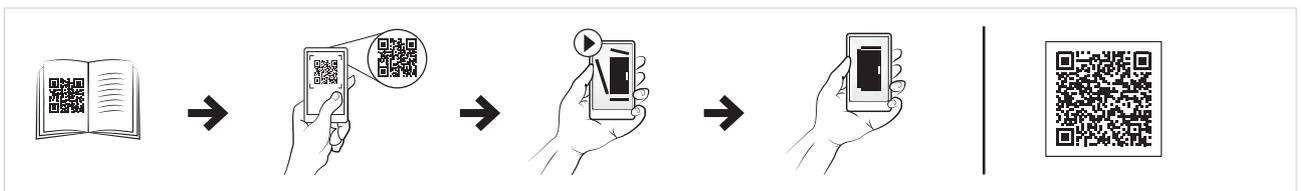

Floor Standing Enclosures

Accessories

Door wheel, DW

Description: For easier closing and positioning of a heavily equipped door (cooling units, etc). Mounted directly to the door frame on the bottom of the door. Highly recommended when fitting loads from 30 kg on the enclosure door.

Pack quantity: 2 pieces with mounting accessories.

Item no.
DW01



Document pockets, DRB

Description: A large steel document pocket fixed directly onto the door frame. Usable depth: 68 mm.

Finish: RAL 7035 structured powder coating.

Pack quantity: 1 piece with mounting accessories.

Description	Material	Item no.
Universal document pocket 300mm wide	1.5 mm mild steel	DRB0303R5
For 600 mm doors	1.5 mm mild steel	DRB600R5
For 800 mm doors	1.5 mm mild steel	DRB800R5

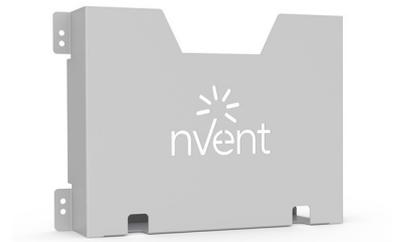

Door frame mounting profiles, DCP

Description: Horizontal profiles with 25 mm hole pattern. Fits directly onto the door frame. For easy mounting of light equipment by using CNT05 screws, hole pattern of 4.5 mm and 6.5 mm in diameter.

Material: 2 mm zinc plated steel.

Pack quantity: 20 bars with mounting accessories.

W	Item no.
400	DCP402
500	DCP502
600	DCP602
800	DCP802
1000	DCP1002

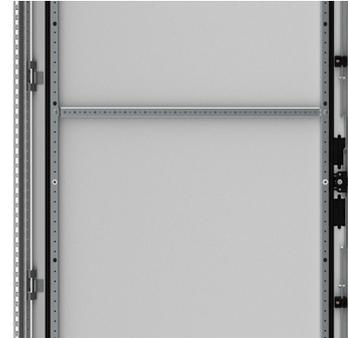

Drawing desks, DDK

Description: Mounted directly to the door frame it provides a solid surface for documents, computer or measuring devices. The desk can be easily folded and locked within the door frame space. An automatic safety positioning system locks the desk at angles of 55°, 70° and 90°. The DDK800R5 can also be mounted on a 1000 mm wide door, by the use of the DCP1002 accessory.

Material: 1.35 mm mild steel.

Finish: RAL 7035 structured powder coating.

Pack quantity: 1 piece with mounting accessories.

W	Item no.
600	DDK600R5
800	DDK800R5



Floor Standing Enclosures

Accessories

Door switch, DSW

- Description:** Door switch to activate any electrical device (lighting, signalling, alarms, etc.). Can be mounted after installing the enclosure thereby keeping the door opening free. Fixed on the inside hole pattern of the enclosure's frame in floor standing enclosures. Cable entry M20.
- Switch capacity:** 3 A / 240 V.
- Approvals:** CE, cCSAus, CCC.
- Pack quantity:** 1 piece with mounting accessories.

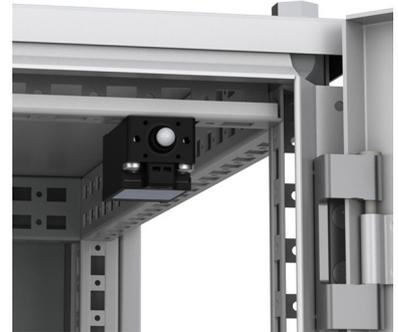

Item no.
DSW01

Universal keyboard trays, UKT

- Description:** Horizontal hinged keyboard tray with lateral sliding mouse pad (L.H. or R.H.). Equipped with panel stay. When the tray is folded out, the enclosure is sealed for dust ingress by a closed chamber.
- Material:** 1.75 mm steel plate.
- Finish:** RAL 7035 structured powder coating.
- Pack quantity:** 1 door with hinges, lock, keyboard mounting support, mouse pad and mounting accessories.



H	W	Item no.
250	600	UKT06R5
250	800	UKT08R5

Lift handle lock covers, LLH

- Description:** Lift handle for LHC locking inserts/half cylinders.
- Material:** Zamak.
- Pack quantity:** 1 lift handle.
- Mounting requirements:** Add LHC inserts/half cylinders when required.



Description	Finish	Compatible inserts	Item no.
Without padlocking	RAL 9005	LHC522 / LHC523 / LHC524 / LHC526 / LHC527 / LHC528 / LHC529 / LHC530 / LHC531 / LHC536	LLH501N
Without padlocking	RAL 9005	LHC533 / LHC534 / LHC535 / LHC5212132E / LHC5213121E	LLH502N
With padlocking	RAL 9005	LHC522 / LHC523 / LHC524 / LHC526 / LHC527 / LHC528 / LHC529 / LHC530 / LHC536	LLH503N
With padlocking	RAL 9005	LHC533 / LHC534 / LHC535 / LHC5212132E / LHC5213121E	LLH504N

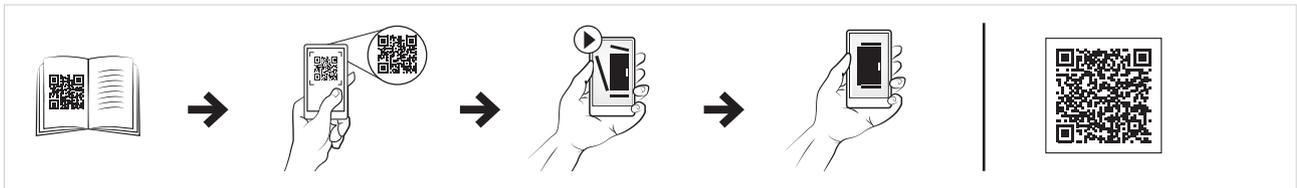

Floor Standing Enclosures

Accessories

Inserts, LI

Description: Inserts to replace the standard double-bit 3 mm insert in the standard lock cover.

Material: Zamak.

Pack quantity: 1 piece.



Description	Item no.
Double-bit 3 mm	LI503
Double-bit 5 mm	LI505
Square 7 mm	LI523
Square 8 mm	LI524
Triangular 7 mm	LI526
Triangular 8 mm	LI527
Daimler Benz	LI530

Locking system for lift handles, LHC

Description: Profile half cylinder locks. To be used in the lift handles LHC.

Pack quantity: 1 piece.



Additional information	Compatible handle	Item no.
Profile half cylinder Ronis key C21323	LLH502N/LLHS502N/LLH504N	LHC521
Round cylinder Ronis key C21323	LLH501N/LLHS501N/LLH503N	LHC522
Square 7 mm	LLH501N/LLHS501N/LLH503N	LHC523
Square 8 mm	LLH501N/LLHS501N/LLH503N	LHC524
Triangle 7 mm	LLH501N/LLHS501N/LLH503N	LHC526
Triangle 8 mm	LLH501N/LLHS501N/LLH503N	LHC527
Double-bit 3 mm	LLH501N/LLHS501N/LLH503N	LHC528
Double-bit 5 mm	LLH501N/LLHS501N/LLH503N	LHC529
Daimler Benz	LLH501N/LLHS501N/LLH503N	LHC530
Lock insert slotted 2x4 mm	LLH502N/LLHS502N/LLH504N	LHC531
Cylinder N°E1 (VW), key excluded	LLH502N/LLHS502N/LLH504N	LHC533
Adapter for other profile half cylinders (DIN18252)	LLH502N/LLHS502N/LLH504N	LHC534
Adapter for ASSA ABLOY and Trioving cylinders	LLH502N/LLHS502N/LLH504N	LHC535
Push button only	LLH501N/LLHS501N/LLH503N	LHC536
Profile half cylinder Ronis key 2132E	LLH502N/LLHS502N/LLH504N	LHC5212132E
Profile half cylinder Ronis key 3121E	LLH502N/LLHS502N/LLH504N	LHC5213121E

* Other key numbers available on request.
 ** Key numbers 333, 1333, EK333 and GX130 are equal.
 *** Order separate key LSMK for Square 8 mm and Triangle 8 mm.

Lift handle lock covers, LLHS

- Description:** Lift handle for LHC locking inserts/half cylinders.
- Material:** Zamak.
- Pack quantity:** 1 lift handle.
- Mounting requirements:** Add LHC inserts/half cylinders when required.



Description	Finish	Compatible inserts	Item no.
Without padlocking	Chrome	LHC522 / LHC523 / LHC524 / LHC526 / LHC527 / LHC528 / LHC529 / LHC530 / LHC531 / LHC536	LLHS501N

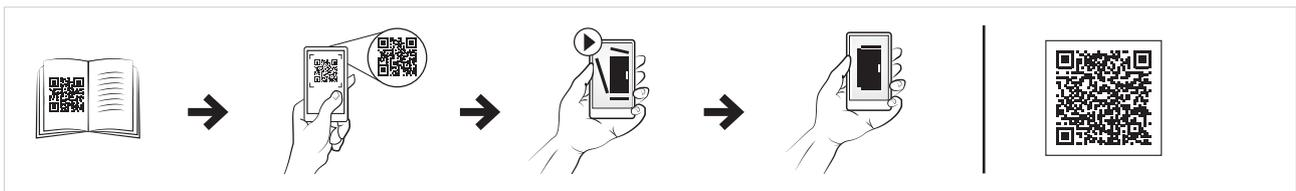

T-handles, LLTH

- Description:** T-handle with or without Ronis cylinder lock.
- Material:** Handle: plastic. Lock: steel.
- Pack quantity:** 1 piece.



Description	Item no.
Without cylinder	LLTH560CEN
With Ronis cylinder key nr. C21323	LLTH560N
With Ronis cylinder key nr. 2132E	LLTH5602132EN
With Ronis cylinder key nr. 3121E	LLTH5603121EN
With Ronis cylinder key nr. 3524E	LLTH5603524EN

Floor Standing Enclosures

Accessories

System actuator, FMA

- Description:** Used with suited multiple enclosure installations. Activates the locking of the slave doors when the master door is closed. One per master door.
- Material:** Zinc plated steel.
- Pack quantity:** 1 piece with mounting material.

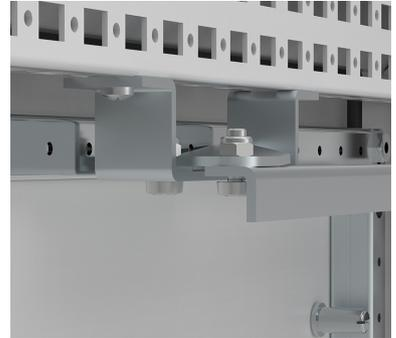

Item no.
FMA01

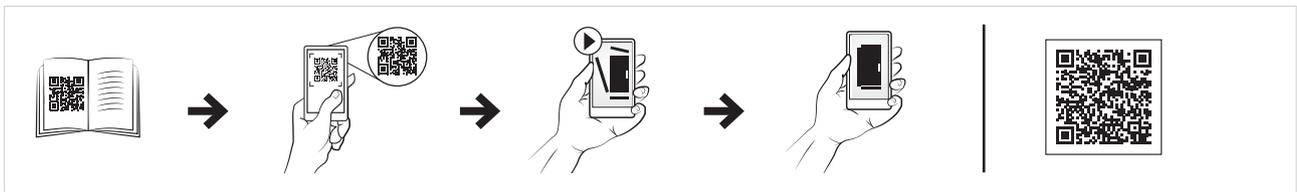

Main door interlock kit, FMD

- Description:** Locks or releases the main door after the power has been switched. Universal adapter permits all popular manufacturers variable depth actuators without modification.
- Material:** Zinc plated steel.
- Pack quantity:** 1 piece with mounting material.

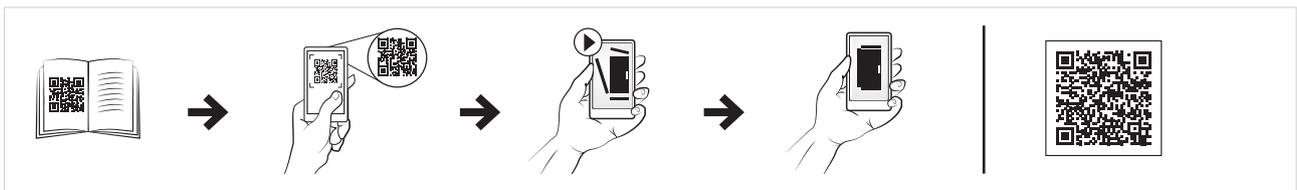

Interlock bars, FMB

Description: For MCF/MCS enclosures. Interlock rods mechanically link all slave doors to the master door. Rod length corresponds to enclosure door width.

Material: Zinc plated steel.

Pack quantity: 5 pieces with mounting material.



W	Item no.
600	FMB600
800	FMB800
1000	FMB1000
1200	FMB1200

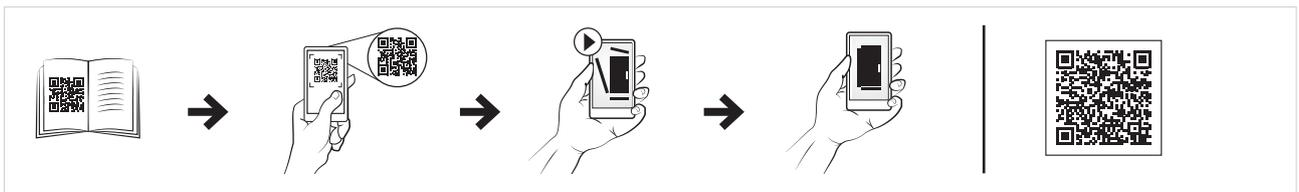

Slave door interlock kit, FMS

Description: Mounted to the slave door of both single and double door enclosures. Slave door is prevented from opening when master door is closed. This safety feature can be activated separately even when the main door interlocking device is not installed. One set per slave door is needed.

Material: Zinc plated steel.

Pack quantity: 1 set with mounting material.

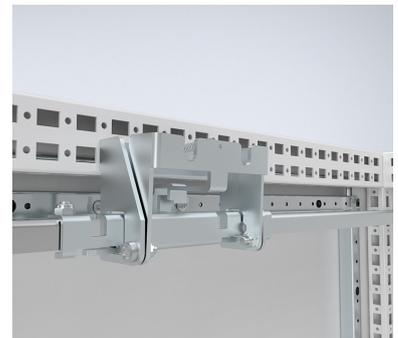

Item no.
FMS01

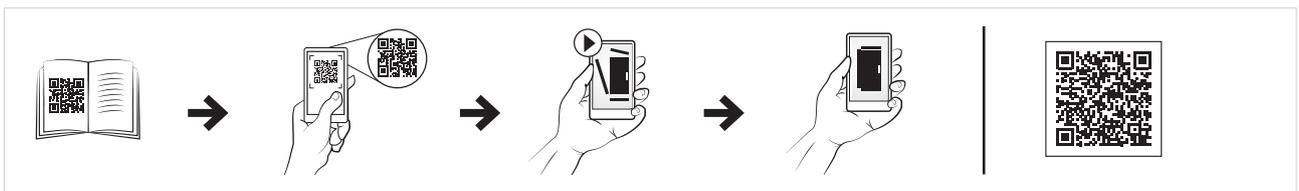

Floor Standing Enclosures

Accessories

Side panels, SPM

- Description:** Easy one man assembly. Sealed by an extruded, one piece polyurethane gasket and mounted with 8 screws and new patented retainers. Can be replaced by the side door DS.
- Material:** 1.5 mm steel plate.
- Finish:** RAL 7035 structured powder coating.
- Protection:** IP 55 | TYPE 12 in combination with MCS. IP66 | TYPE 4, 12 in combination with MCS-HP.
- Pack quantity:** 2 panels with mounting accessories.

For enclosure		
H	D	Item no.
1800	400	SPM1804R5
1800	500	SPM1805R5
1800	600	SPM1806R5
2000	400	SPM2004R5
2000	500	SPM2005R5
2000	600	SPM2006R5
2000	800	SPM2008R5
2200	600	SPM2206R5
2200	800	SPM2208R5

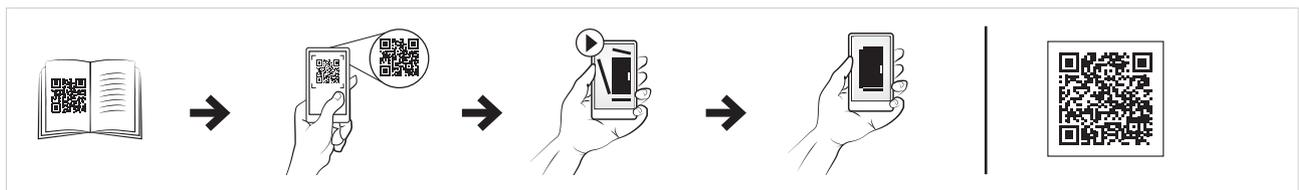
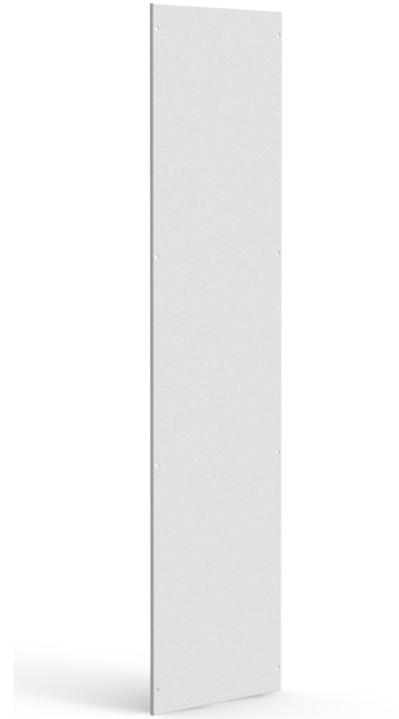

Side panels, stainless steel, SPMS

- Description:** Easy one man assembly. Sealed by an extruded, one piece polyurethane gasket and mounted with 8 screws and new patented retainers.
- Material:** 1.5 mm AISI 304 / AISI 316L pre-grained stainless steel.
- Finish:** 400 pre-grained stainless steel.
- Protection:** IP 55 | TYPE 12 in combination with MCSS. IP66 | TYPE 4X, 12 in combination with MCSS-HP.
- Pack quantity:** 2 panels with mounting accessories.

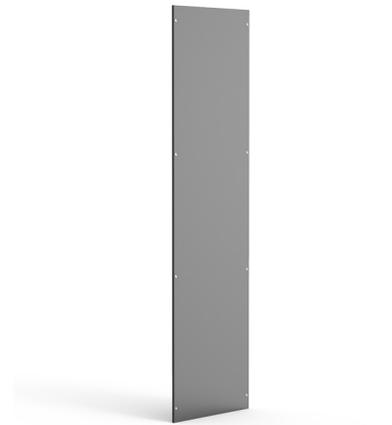

For enclosure		
H	W	Item no.
1800	500	SPMS1805
2000	600	SPMS2006

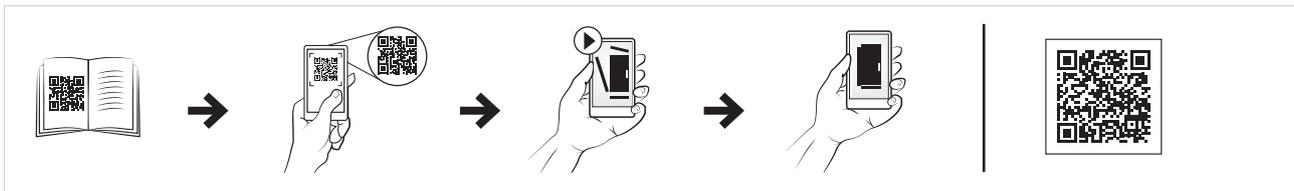

Internal baying brackets, CCI

- Description:** Quick fixation baying brackets provide a rigid reinforcement of the enclosure assembly. The correct spacing between the enclosures is assured. Tools are not required for installation.
- Material:** 3 mm zinc plated steel.
- Pack quantity:** 6 brackets with mounting accessories.



Item no.
CCI06

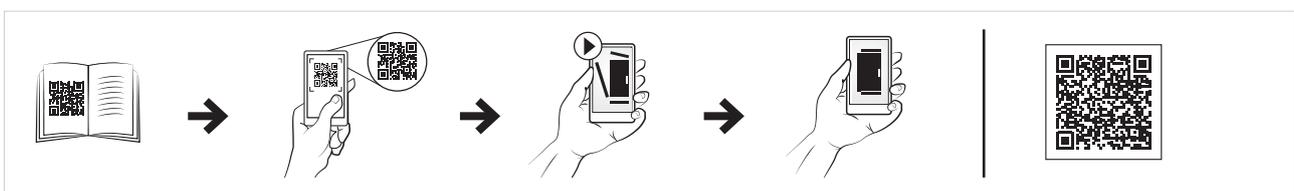

Floor Standing Enclosures

Accessories

Internal baying brackets, CCI08IP66

Description: Baying brackets provide a rigid reinforcement of the enclosure assembly. The correct spacing between the enclosures is assured. Tools are not required for installation.

Material: 3 mm Stainless Steel 316L

Pack quantity: 8 brackets with mounting accessories.

Item no.
CCI08IP66

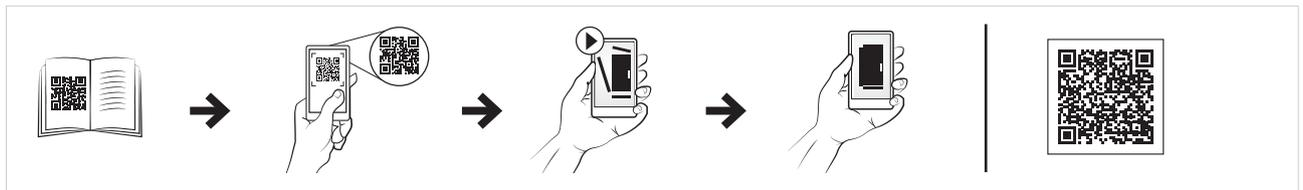

Internal baying brackets, CCTV

Description: Brackets that enable baying of modular enclosures, MCS/MCD, with the previous generation of enclosures from another leading brand in the market.

Material: 3 mm zinc plated steel.

Pack quantity: 6 brackets with mounting accessories.

Item no.
CCTV06

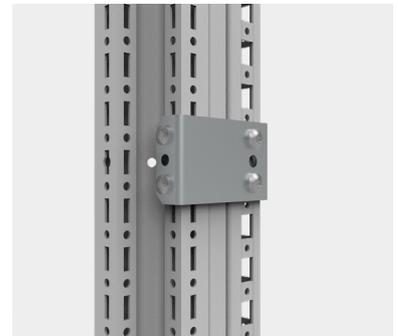

External baying brackets, CCE

Description: Brackets mounted on the outside hole pattern of the frame ensuring a strong and 3 dimensional alignment of the mild steel bayed enclosures with an "auto spacer" function. This method of baying enclosures also has the advantage of creating a direct earthing connection between the enclosure frames.

Material: 3 mm zinc plated steel.

Pack quantity: 6 brackets with mounting accessories.

Item no.

CCE06

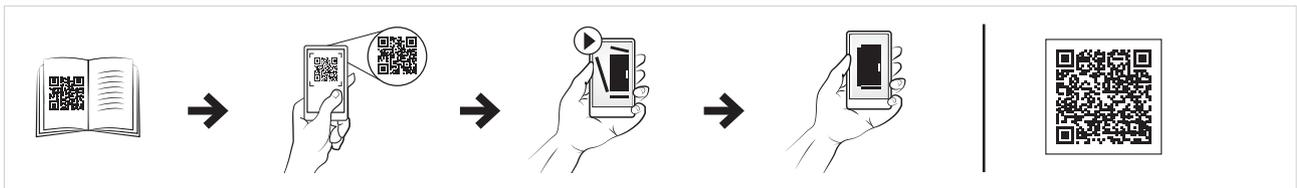

Internal corner baying kit, CCM

Description: For extra support when bayed enclosures are fully equipped and require lifting. Can be used together with SPD separation plates.

Material: 3 mm zinc plated steel.

Pack quantity: 4 brackets with mounting accessories.

Item no.

CCM04

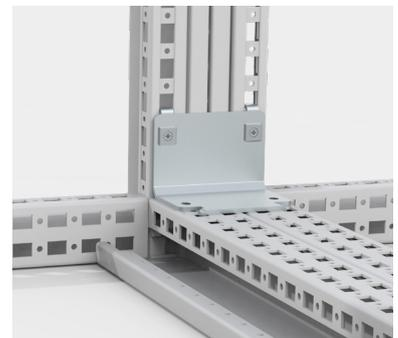

Floor Standing Enclosures

Accessories

Internal top and bottom baying kit, CCM04IP66

- Description:** For extra support when bayed enclosures are fully equipped and require lifting.
- Material:** 3 mm stainless steel 316L.
- Pack quantity:** 6 brackets with mounting accessories.

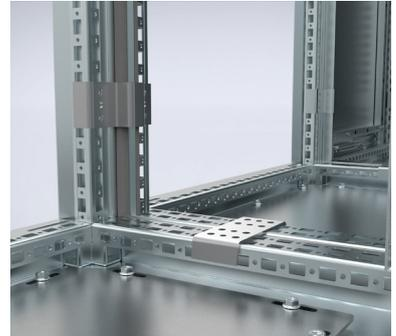

Item no.
CCM04IP66

Short external baying brackets, CCEH

- Description:** Short brackets mounted on the outside hole pattern of the frame of the bayed enclosures with an "auto spacer" function. Specially designed for small doors/panels configuration. This method of baying mild steel enclosures has also the advantage of creating a direct earthing connection between the enclosure frames.
- Material:** 3 mm zinc plated steel.
- Pack quantity:** 6 brackets with mounthing material.



Item no.
CCEH06

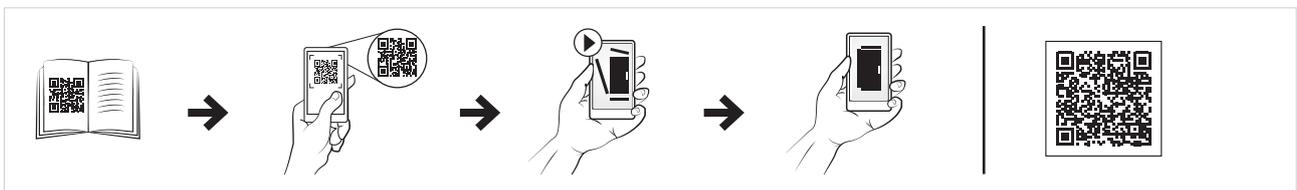

Depth baying kit, CJDN

- Description:** For baying enclosures rear to rear.
- Material:** Covers: 2 mm mild steel. Brackets: 3 mm zinc plated steel.
- Finish:** RAL 7035.
- Protection:** IP 55
- Pack quantity:** 1 kit with mounting accessories.

For enclosure		
H	W	Item no.
1800	600	CJDN1806R5
1800	800	CJDN1808R5
1800	1000	CJDN1810R5
2000	600	CJDN2006R5
2000	800	CJDN2008R5
2000	1000	CJDN2010R5
2200	600	CJDN2206R5
2200	800	CJDN2208R5



Floor Standing Enclosures

Accessories

Separation plates for MCS and MCD enclosures, SPD

- Description:** Separates two bayed MCS/MCD enclosures.
- Material:** 1.5 mm zinc plated steel.
- Mounting requirements:** IP 43 | TYPE 1 sealing can be obtained by using SPDG gasket. CCJ brackets are required to mount the SPD into the enclosures. To bay enclosures together, use CCM and CCI brackets. For EMI shielding the SPDEG gasket must be used.
- Pack quantity:** 1 piece.



For enclosure		
H	D	Item no.
1800	400	SPD1804
1800	500	SPD1805
1800	600	SPD1806
2000	400	SPD2004
2000	500	SPD2005
2000	600	SPD2006
2000	800	SPD2008
2200	600	SPD2206
2200	800	SPD2208

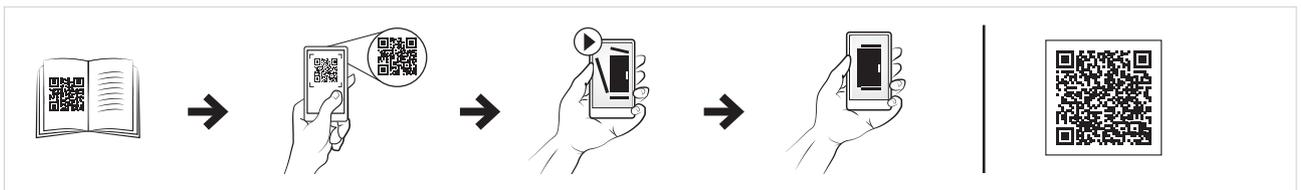

Separation plates for MCSS, MCDS and ECOM enclosures, SPDS



- Description:** Separates two bayed MCSS/MCDS/ECOM enclosures.
- Material:** 1.5 mm zinc plated steel.
- Mounting requirements:** IP 43 | TYPE 1 sealing can be obtained by using SPDG gasket. CCJ brackets are required to mount the SPDS into the enclosures. To bay enclosures together, use CCM and CCI brackets. For EMI shielding the SPDEG gasket must be used.
- Pack quantity:** 1 piece.

For enclosure		
H	D	Item no.
1800	500	SPDS1805
2000	600	SPDS2006

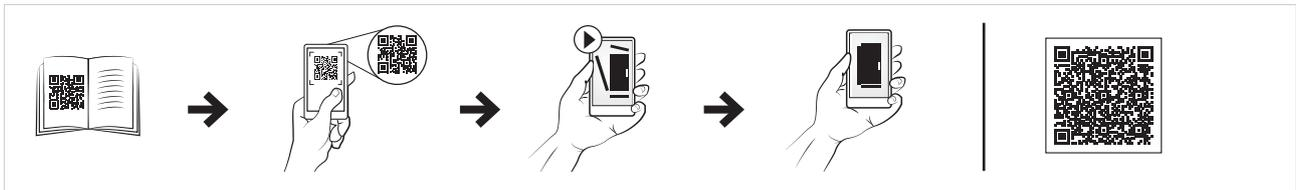

Separation plate gasket, SPDG

- Description:** To obtain IP 43 | TYPE 1 sealing in combination with the separation plate SPD/SPDS.
- Material:** Neoprene 5x15/20.
- Pack quantity:** 6 m.



Item no.
SPDG01

Floor Standing Enclosures

Accessories

Separation plate brackets, CCJ

Description: Mounted to the enclosure's frame. Can be used on both vertical and the horizontal profiles.

Material: 3 mm zinc plated steel.

Pack quantity: 6 brackets with mounting accessories.

Item no.
CCJ06



Baying gasket for IP66, HPPG01

Description: To obtain IP66 | Type 4 (4X), 12 sealing in bayed configuration of MCS-HP/MCSS-HP in combination with CCJ06 and CCM04.

Material: EPDM, 5 mm thickness.

Pack quantity: 1 pad compatible with all enclosure dimensions.

Item no.
HPPG01

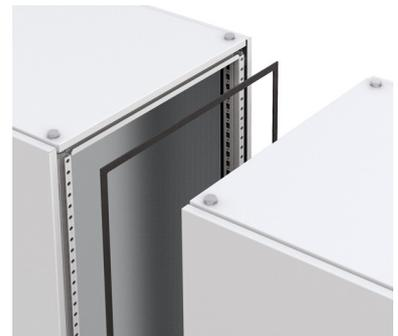

Lifting eye bolts, LE

- Description:** Mounts directly to the frame corner pieces of the enclosure for when lifting operations are required. Complies with DIN 580 lifting requirements. M12 thread.
- Maximum load:** 3400N per lifting eye with max angle of 45°. Please follow Eldon lifting instructions.
- Pack quantity:** 4 pieces.



Material	Item no.
Zinc plated	LE9304
Stainless steel 304	LE9304SS

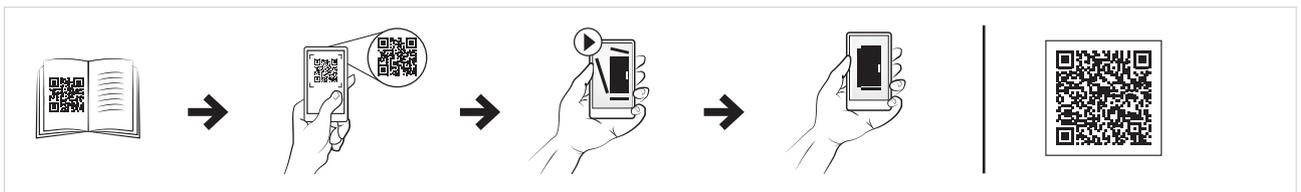

Lifting devices, LC

- Description:** For optimal weight distribution when lifting bayed enclosures. To be used in combination with baying bracket.
- Pack quantity:** 2 pieces with mounting accessories.



Material	Item no.
Zinc plated	LC02
Stainless steel 316L	LC02-316

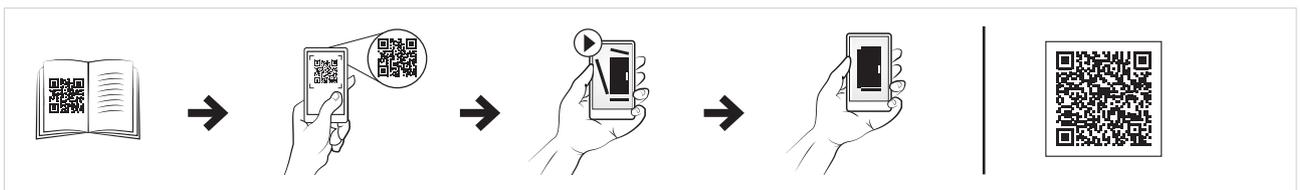

Floor Standing Enclosures

Accessories

Ventilation roofs, CVR

- Description:** Raised roof with 2.5 mm ventilation slots and filter material.
- Material:** 1.5 mm steel plate. Filter material: EU 4 according to DIN 24185.
- Finish:** RAL 7035 structured powder coating.
- Temperature resistance:** 100°C.
- Protection:** Complies with IP 31 | TYPE 1.
- Pack quantity:** 1 piece with mounting brackets and ventilation filter.
- Note:** Increases the enclosure height by 40 mm.



For enclosure		
W	D	Item no.
500	500	CVR0505R5
600	300	CVR0603R5
600	400	CVR0604R5
600	500	CVR0605R5
600	600	CVR0606R5
600	800	CVR0608R5
800	300	CVR0803R5
800	400	CVR0804R5
800	500	CVR0805R5
800	600	CVR0806R5
800	800	CVR0808R5
800	900	CVR0809R5
1000	300	CVR1003R5
1000	400	CVR1004R5
1000	500	CVR1005R5
1000	600	CVR1006R5
1000	800	CVR1008R5
1200	300	CVR1203R5
1200	400	CVR1204R5
1200	500	CVR1205R5
1200	600	CVR1206R5
1200	800	CVR1208R5
1600	400	CVR1604R5
1600	500	CVR1605R5
1600	600	CVR1606R5

Fan roof plates, CFR

- Description:** For mounting a combination of 6 fans DFN or closing plates DFC for unused holes in the top of the enclosure.
- Material:** 2 mm zinc plated steel.
- Mounting requirements:** Add Ventilation roof CVR. Use fan DFN. Unused holes should be closed with DFC.
- Pack quantity:** 1 piece with mounting accessories.

W	D	N° of cut outs	Item no.
600	600	6	CFR0606
600	800	6	CFR0608
800	600	6	CFR0806
800	800	6	CFR0808



Ventilation fans, DFN

- Description:** Two ventilation fan versions: DFN01 for mounting to a surface from below, DFN02 for mounting on top of a surface, with flow always pointing upwards. Extra contact provided for thermostat connection.
- Voltage:** 220-240 VAC.
- Air circulation:** 160 m³/h.
- Power of the fan:** 19 Watt.
- Pack quantity:** 1 set with finger guards and mounting screws.
- Note:** For easy connection use wiring kit DFN61.

Description	Item no.
Inside mounting	DFN01
Top mounting	DFN02

When ventilator holes are not used they can be closed with DFC closing plates.



Floor Standing Enclosures

Accessories

Wiring kit, DFN61

- Description:** Wiring kit for a maximum connection of 6 fans (DFN) and 1 thermostat/hygrostat (ETR/ETF). The thermostat or hygrostat can be connected through the separate terminal mounted on the side.
- Pack quantity:** 1 set containing: |- 1 DIN rail 15 cm |- 1 L- connector block |- 1 N-connector block |- 1 PE-connector block |- 1 Free terminal |- 1 Power cable with Schuko/UTE plug, 2,5 m |- 6 Pieces blue connection cables 81 cm |- 6 Pieces black connection cables 81 cm |- 6 Pieces green/yellow earthing cables 81 cm |- 6 Pieces self adhesive cable feet |- 8 Mounting screws.

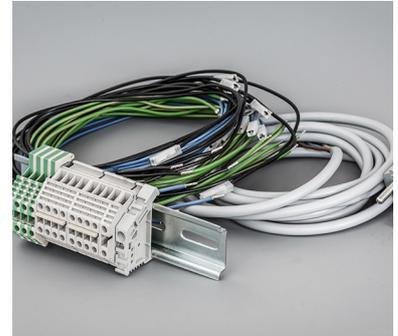

Item no.
DFN61

Closing plates, DFC

- Description:** Closing plate for an unused fan (DFN) opening.
- Material:** 1.5 mm zinc plated steel.
- Pack quantity:** 4 piece with mounting accessories.

Item no.
DFC04



Ventilated bottom plates, CVB

- Description:** Can be used in combination with a ventilated plinth PV. 33% ventilated.
- Material:** 1.5 mm perforated zinc plated steel.
- Pack quantity:** 3 pieces, 4 pieces for D>600mm, with mounting material.
- Mounting requirements:** Use in combination with ventilated plinths PV.

For enclosure		
W	D	Item no.
600	600	CVB0606
600	800	CVB0608
800	600	CVB0806
800	800	CVB0808
1200	600	CVB1206
1200	800	CVB1208



Spacer kits, CVK

- Description:** Provides ventilation by raising the enclosure's roof panel 15 mm (CVK15), 50 mm (CVK50).
- Material:** Zinc plated steel.
- Pack quantity:** 4 pieces with mounting accessories.

Description	Item no.
Raises the roof 15 mm	CVK15
Raises the roof 50 mm	CVK50



Floor Standing Enclosures

Accessories

Section profiles for cable entry, SCE

- Description:** For sealing the cable entry between gland plates. Forms a tight seal around cables and fills gaps to prevent dust from entering. The foam is pre-fitted in the section profile that can be easily mounted in the bottom plates thanks to its click-in fixing solution. An alternative to the bottom late gasket kit BG01.
- Material:** Extruded PVC section profile. Gasket: adhesive foam with cross-section of 30 x 25 mm.
- Pack quantity:** 1 set consisting of 2 click-in section profiles with foam rubber.

For enclosure	
W	Item no.
600	SCE600
800	SCE800
1000	SCE1000
1200	SCE1200



Inside cable fixing bars, CAB

- Description:** Mounted above the bottom plates. Holds standard cable clamps CAC to secure incoming cables. Fully adjustable in depth. When EMC shielded earthing cables are connected to the support bar the Faraday effect will be kept intact for maximum EMI shielding.
- Material:** 2 mm zinc plated steel.
- Pack quantity:** 2 bars with mounting accessories.
- Mounting requirements:** Add CAC clamps depending on diameter of the cable(s).

For enclosure	
W	Item no.
400	CAB400
600	CAB600
800	CAB800
1000	CAB1000
1200	CAB1200



Cable entry foam and bottom plate gaskets, BG

- Description:** The bottom of the enclosure is sealed by the use of an adhesive gasket applied on to the frame around the openings at the bottom of the enclosure. The cables are sealed by the addition of adhesive foam placed between the bottom plates. The elasticity and the size of this foam ensures a tight seal around most cables.
- Pack quantity:** 1.6 m adhesive foam (30 x 25 mm) and 6 m adhesive gasket (4.5 x 8 mm). For 1600 mm wide enclosures please order 2 sets.



Item no.
BG01

Outside cable fixing bars, CABP

- Description:** Suspended below the bottom plates, thereby maximizing the full usable space in the enclosure. Holds standard cable clamps CAC to secure incoming cables. Fully adjustable in depth. When EMC shielded earthing cables are connected to the support bar the Faraday effect will be kept intact for maximum EMI shielding.
- Material:** 2 mm zinc plated steel.
- Pack quantity:** 2 bars with mounting accessories. For 1200 mm wide, 4 bars with mounting accessories.
- Mounting requirements:** Add CAC clamps depending on diameter of cable.



For enclosure	
W	Item no.
400	CABP400
500	CABP500
600	CABP600
800	CABP800
1000	CABP1000
1200	CABP1200

Floor Standing Enclosures

Accessories

Cable clamps, CAC

- Description:** To secure incoming cables onto the fixing bars CAB and CABP. Holds the cable in position and supports the weight.
- Material:** Zinc plated steel.
- Pack quantity:** 25 clamps.
- Mounting requirements:** Add CAB/CABP to mount the cable clamps CAC.



Size	Item no.
06-12	CAC0612
10-14	CAC1014
12-16	CAC1216
14-18	CAC1418
18-22	CAC1822
22-26	CAC2226
26-30	CAC2630
30-34	CAC3034
34-38	CAC3438
38-42	CAC3842
42-46	CAC4246
58-64	CAC5864

Raised side doors, DNSR

- Description:** A 200 mm wide cover with cable entrances in top and bottom. Supplied with one gland plate and gasket. Hole pattern equals enclosure's frame to mount cable fixing bars.
- Material:** 2 mm.
- Finish:** RAL 7035 structured powder coating.
- Protection:** Complies with IP 33 | TYPE 1 in combination with MM connector plate and gasket SPDG01. Door frame optional.
- Mounting requirements:** Add a separation plate SPD or marshalling plate MM to mount connectors and separate the side compartment.
- Pack quantity:** 1 piece with mounting accessories.



For enclosure		
H	D	Item no.
2000	500	DNSR2005R5
2000	600	DNSR2006R5

Cover plates, MMG

Description: To cover unused connector cut-outs of a marshalling plate MM, or to adapt to 16 pins connectors to allow the mix of both connector types.

Material: 2 mm zinc plated steel.

Pack quantity: For quantity see table. Including mounting accessories and seal.

Description	Size	Pack quantity	Item no.
Cover plate	16 pin	20	MMG16

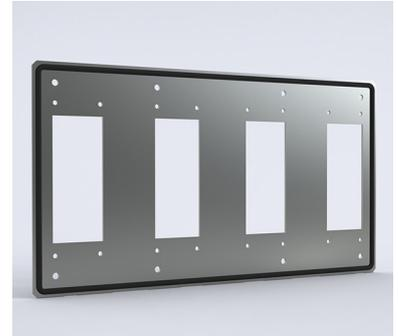

Earthing cables, ECFA

Description: For earthing between metallic parts.

Material: 6 mm² copper wire (yellow-green).

Pack quantity: 10 pieces.

Mounting requirements: Add connection set ECF for fixing cable to painted frame.

Length	Connection size	Item no.
220 mm	M6 / M8	ECFA220
300 mm	M8 / M8	ECFA300

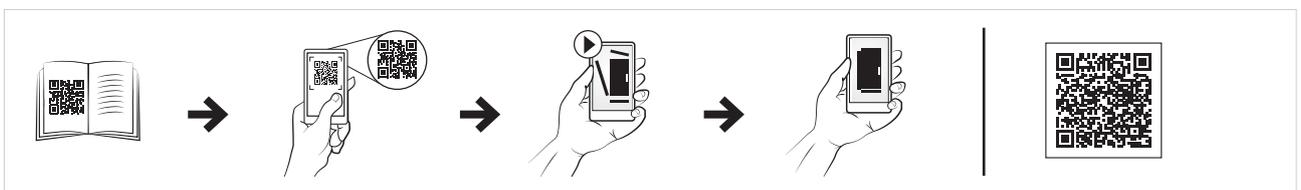

Floor Standing Enclosures

Accessories

Earthing straps, ECFE

- Description:** For earthing and potential compensation between panels, parts and the enclosure's frame.
- Length:** 300 mm.
- Material:** Tinned electrolytic copper 0.15 mm wire.
- Working temperature:** Up to 105°C.
- Pack quantity:** 10 pieces.
- Mounting requirements:** Add ECF connection set for fixing strap to painted frame.



Cross sectional area	Holes diam.	Current (A)	Item no.
16 mm ²	8.5	120 A	ECFE1630
25 mm ²	10.5	150 A	ECFE2530

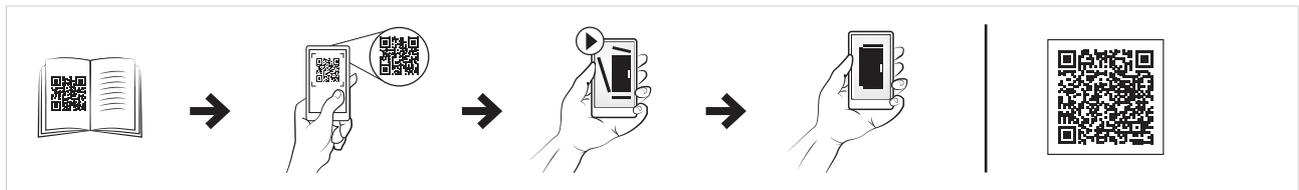

Earthing connections for frames, ECF

- Description:** Earthing connections for fixing the earthing straps and cables to the enclosure's frame.
- Pack quantity:** 10 sets.

Bolt size	Item no.
M6	ECF06
M6	ECF06S
M8	ECF08

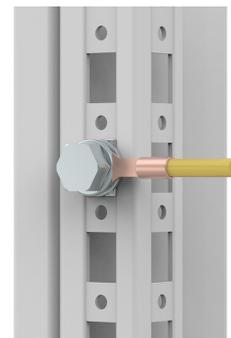

Central earthing point, ECFP

- Description:** Provides earthing contact surface on horizontal or vertical frame profiles. For a secure earthing point with multiple connections.
- Material:** Galvanized steel.
- Pack quantity:** 3 central earthing points with mounting accessories. M8 earthing kit included for the three holes.

Item no.
ECFP08

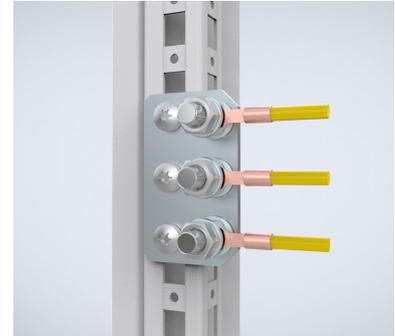

Earthing connection for panels, ECP

- Description:** Earthing connection for fixing the earthing straps and cables to panels, mounting plates or profiles.
- Pack quantity:** 10 sets.

Bolt size	Item no.
M6	ECP06
M8	ECP08

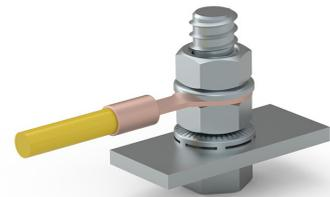

Wall Mounted Enclosures



10 MINUTES SAVED

for each wall mounted enclosure with the below accessories

- 1 x MOUNTING PLATE
- 3 x 180° HINGES
- + x PROFILES



FAST ASSEMBLY



Mounting plate

Machining free 180° hinges

Profiles

OPTIMUM PROTECTION



Door positioning for large enclosures

Low water absorption gasket

Silicon for 316 steel



APPEALING DESIGN



Red gasket
304 stainless
enclosures

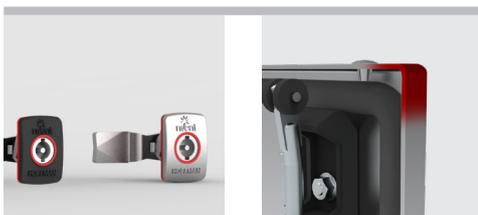

Lock cover

Door corner
forming
stainless steel

Wall Mounted
Mild Steel
Mild steel, single door enclosure | MAS

IP 66 | TYPE 4, 12 | IK 10



Material:

Body: 1.2 mm mild steel for enclosures with a depth of 155 mm / 1.4 mm for enclosures with a depth of 210 or 260 mm / 1.5 mm for enclosures with a depth of 300 or 400 mm, or if a height or width is 1000 mm or greater. Gland plate: 1.4 mm mild steel. Door: 1.2 mm mild steel / 1.5 mm for enclosures with a height or width of 500 mm or greater / 2 mm for enclosures with a height or width of 800 mm or greater. Mounting plate: 2 mm galvanized steel.

Body:

Folded and seam welded. Four 8.5 mm diameter holes for wall fixing, pressed out in 20.4 mm diameter x 2 mm depressions, to allow air circulation around the rear part of the enclosure.

Door:

Surface mounted with 130° opening. Concealed removable hinges with captive pin. Hinges can be mounted to allow left or right hand opening. Inner M6 welded studs to mount door profiles MMDP. Sealing is ensured by an injected one piece polyurethane gasket.

Lock:

Customized lock with double-bit for easy opening of the door. Double-bit 3 mm insert and 90° movement. 1000 mm high enclosures and above have espagnolette three point locking. Other inserts are available as an accessory.

Mounting plate:

The mounting plate is marked vertically at 10 mm intervals, for easy horizontal positioning of equipment. On the top and bottom there are holes to facilitate cable fixing. Fixed onto M8 press welded studs to the rear of the enclosure. All sides, from 800 mm and above, are strengthened by folded edges. By using the AMG accessory, the mounting plate position can be adjusted to any depth.

Gland Plate Opening:

Situated at the far rear of the enclosure, to make cabling onto the mounting plate easier.

Protection:

Complies with IP 66 | TYPE 4, 12 | IK 10. For outdoor installation, the use of a rain hood ARF and 100% polyester paint coating is recommended. The corrosion resistance must be taken into consideration.

Finish:

RAL 7035 structured powder coating.

Delivery:

Enclosure with door. For height 600 mm and above, two door mounting profiles. Gland plate(s) with gasket(s), plastic double-bit 3 mm key, and mounting accessories. Metallic key, for height 1000 mm and above. Earthing facilities.



Dimensional table | MAS

IP 66 | TYPE 4, 12 | IK 10

With mounting plate

Enclosure dimensions			Mounting plate dimensions		Usable depth	Gland plate			N° of locks	Item no.
H	W	D	h	w	d	Size	Type	Openings		
200	200	155	170	150	137	110 × 56	0S	1	1	MAS0202015R5
250	200	155	220	150	137	110 × 56	0S	1	1	MAS0252015R5
250	250	155	220	200	137	110 × 56	0S	1	1	MAS0252515R5
300	250	155	270	200	137	110 × 56	0S	1	1	MAS0302515R5
300	250	210	270	200	192	110 × 56	0S	1	1	MAS0302521R5
300	300	155	270	250	137	210 × 56	1S	1	1	MAS0303015R5
300	300	210	270	250	192	210 × 96	1	1	1	MAS0303021R5
350	250	155	320	200	137	110 × 56	0S	1	1	MAS0352515R5
400	300	155	370	250	137	210 × 56	1S	1	1	MAS0403015R5
400	300	210	370	250	192	210 × 96	1	1	1	MAS0403021R5
400	400	210	370	350	192	310 × 96	2	1	1	MAS0404021R5
400	500	210	370	450	192	410 × 96	3	1	1	MAS0405021R5
400	600	210	370	550	192	510 × 96	4	1	1	MAS0406021R5
500	300	210	470	250	192	210 × 96	1	1	1	MAS0503021R5
500	400	155	470	350	137	310 × 56	2S	1	1	MAS0504015R5
500	400	210	470	350	192	310 × 96	2	1	1	MAS0504021R5
500	400	260	470	350	242	310 × 96	2	1	1	MAS0504026R5
500	400	300	470	350	282	310 × 96	2	1	1	MAS0504030R5
500	500	210	470	450	192	410 × 96	3	1	1	MAS0505021R5
500	500	300	470	450	282	410 × 96	3	1	1	MAS0505030R5
600	400	155	570	350	137	310 × 56	2S	1	2	MAS0604015R5
600	400	210	570	350	192	310 × 96	2	1	2	MAS0604021R5
600	400	260	570	350	242	310 × 96	2	1	2	MAS0604026R5
600	400	300	570	350	282	310 × 96	2	1	2	MAS0604030R5
600	500	155	570	450	137	410 × 56	3S	1	2	MAS0605015R5
600	500	210	570	450	192	410 × 96	3	1	2	MAS0605021R5
600	500	260	570	450	242	410 × 96	3	1	2	MAS0605026R5
600	500	300	570	450	282	410 × 96	3	1	2	MAS0605030R5
600	600	210	570	550	192	510 × 96	4	1	2	MAS0606021R5
600	600	300	570	550	282	510 × 96	4	1	2	MAS0606030R5
600	600	400	570	550	382	510 × 96	4	1	2	MAS0606040R5
600	800	300	570	750	282	310 × 96	2	2	2	MAS0608030R5
700	500	210	670	450	192	410 × 96	3	1	2	MAS0705021R5
700	500	260	670	450	242	410 × 96	3	1	2	MAS0705026R5
800	400	300	770	350	282	310 × 96	2	1	2	MAS0804030R5
800	600	210	770	550	192	510 × 96	4	1	2	MAS0806021R5
800	600	260	770	550	242	510 × 96	4	1	2	MAS0806026R5
800	600	300	770	550	282	510 × 96	4	1	2	MAS0806030R5
800	600	400	770	550	382	510 × 96	4	1	2	MAS0806040R5

With mounting plate

Enclosure dimensions			Mounting plate dimensions		Usable depth	Gland plate			N° of locks	Item no.
H	W	D	h	w	d	Size	Type	Openings		
800	800	210	770	750	192	310 × 96	2	2	2	MAS0808021R5
800	800	300	770	750	282	310 × 96	2	2	2	MAS0808030R5
800	800	400	770	750	382	310 × 96	2	2	2	MAS0808040R5
1000	600	260	970	550	242	510 × 96	4	1	1*	MAS1006026R5
1000	600	300	970	550	282	510 × 96	4	1	1*	MAS1006030R5
1000	800	260	970	750	242	310 × 96	2	2	1*	MAS1008026R5
1000	800	300	970	750	282	310 × 96	2	2	1*	MAS1008030R5
1000	800	400	970	750	382	310 × 96	2	2	1*	MAS1008040R5
1200	600	300	1170	550	282	510 × 96	4	1	1*	MAS1206030R5
1200	800	300	1170	750	282	310 × 96	2	2	1*	MAS1208030R5
1200	800	400	1170	750	382	310 × 96	2	2	1*	MAS1208040R5

Without mounting plate

Enclosure dimensions			Gland plate				N° of locks	Item no.
H	W	D	Size	Type	Openings			
200	200	155	110 × 56	0S	1	1	MAS0202015PER5	
250	200	155	110 × 56	0S	1	1	MAS0252015PER5	
250	250	155	110 × 56	0S	1	1	MAS0252515PER5	
300	250	155	110 × 56	0S	1	1	MAS0302515PER5	
300	250	210	110 × 56	0S	1	1	MAS0302521PER5	
300	300	155	210 × 56	1S	1	1	MAS0303015PER5	
300	300	210	210 × 96	1	1	1	MAS0303021PER5	
350	250	155	110 × 56	0S	1	1	MAS0352515PER5	
400	300	155	210 × 56	1S	1	1	MAS0403015PER5	
400	300	210	210 × 96	1	1	1	MAS0403021PER5	
400	400	210	310 × 96	2	1	1	MAS0404021PER5	
400	500	210	410 × 96	3	1	1	MAS0405021PER5	
400	600	210	510 × 96	4	1	1	MAS0406021PER5	
500	300	210	210 × 96	1	1	1	MAS0503021PER5	
500	400	155	310 × 56	2S	1	1	MAS0504015PER5	
500	400	210	310 × 96	2	1	1	MAS0504021PER5	
500	400	260	310 × 96	2	1	1	MAS0504026PER5	
500	400	300	310 × 96	2	1	1	MAS0504030PER5	
500	500	210	410 × 96	3	1	1	MAS0505021PER5	
500	500	300	410 × 96	3	1	1	MAS0505030PER5	
600	400	155	310 × 56	2S	1	2	MAS0604015PER5	
600	400	210	310 × 96	2	1	2	MAS0604021PER5	
600	400	260	310 × 96	2	1	2	MAS0604026PER5	
600	400	300	310 × 96	2	1	2	MAS0604030PER5	
600	500	155	410 × 56	3S	1	2	MAS0605015PER5	
600	500	210	410 × 96	3	1	2	MAS0605021PER5	
600	500	260	410 × 96	3	1	2	MAS0605026PER5	
600	500	300	410 × 96	3	1	2	MAS0605030PER5	
600	600	210	510 × 96	4	1	2	MAS0606021PER5	
600	600	300	510 × 96	4	1	2	MAS0606030PER5	
600	600	400	510 × 96	4	1	2	MAS0606040PER5	
600	800	300	310 × 96	2	2	2	MAS0608030PER5	
700	500	210	410 × 96	3	1	2	MAS0705021PER5	
700	500	260	410 × 96	3	1	2	MAS0705026PER5	
800	400	300	310 × 96	2	1	2	MAS0804030PER5	
800	600	210	510 × 96	4	1	2	MAS0806021PER5	
800	600	260	510 × 96	4	1	2	MAS0806026PER5	
800	600	300	510 × 96	4	1	2	MAS0806030PER5	
800	600	400	510 × 96	4	1	2	MAS0806040PER5	
800	800	210	310 × 96	2	2	2	MAS0808021PER5	
800	800	300	310 × 96	2	2	2	MAS0808030PER5	
800	800	400	310 × 96	2	2	2	MAS0808040PER5	
1000	600	260	510 × 96	4	1	1*	MAS1006026PER5	
1000	600	300	510 × 96	4	1	1*	MAS1006030PER5	
1000	800	260	310 × 96	2	2	1*	MAS1008026PER5	
1000	800	300	310 × 96	2	2	1*	MAS1008030PER5	
1000	800	400	310 × 96	2	2	1*	MAS1008040PER5	
1200	600	300	510 × 96	4	1	1*	MAS1206030PER5	
1200	800	300	310 × 96	2	2	1*	MAS1208030PER5	
1200	800	400	310 × 96	2	2	1*	MAS1208040PER5	

* 1000 mm high enclosures and above have espagnolette three point locking.

Front view

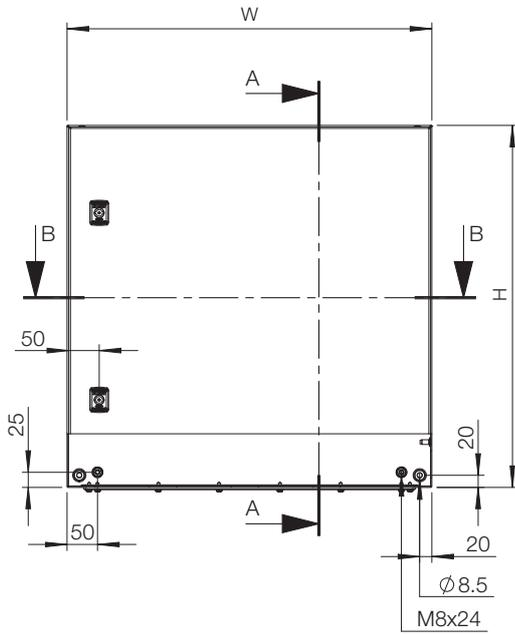

Sectional side view

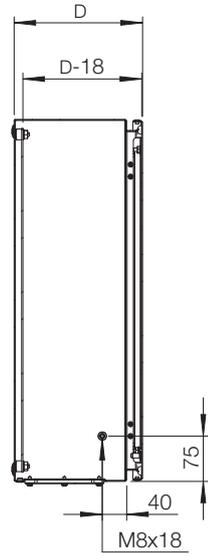

SECTION A-A

Inside door view

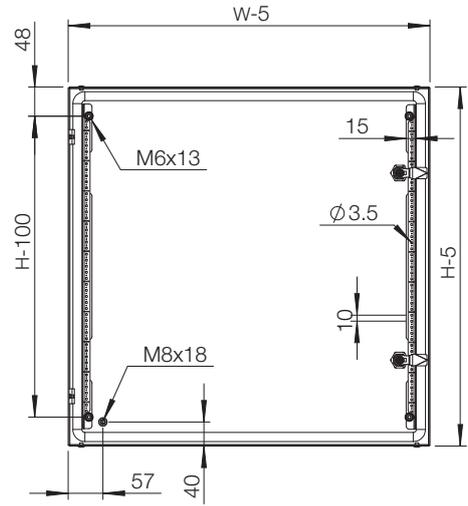

Sectional top view

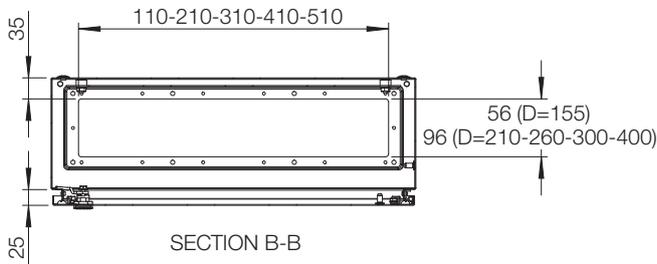

SECTION B-B

Mounting plate view

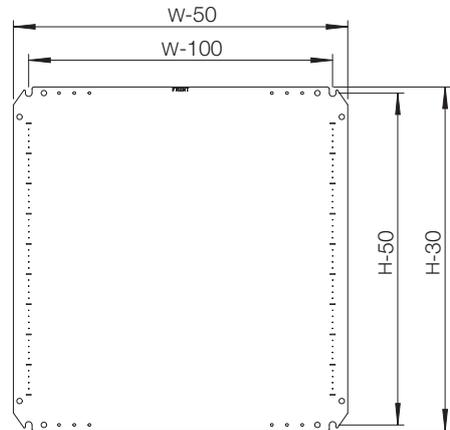

**Wall Mounted
Mild Steel
Double door | MAD**

IP 55 | TYPE 12 | IK 10



Material:

Body: 1.5 mm mild steel. Gland plate: 1.4 mm mild steel. Door: 2 mm mild steel
Mounting plate: 2 mm galvanized steel / 2.5 mm MAD1001030R5 and above.

Body:

Folded and seam welded. Four 8.5 mm diameter holes for wall fixing, pressed out in 20.4 mm diameter × 2 mm depressions, to allow air circulation around the rear part of the enclosure.

Door:

Surface mounted with 130° opening. Concealed removable hinges with captive pin. Inner M6 welded studs to mount door profiles MMDP. Two removable mounting profiles on the right hand door and two on the left hand door. Sealing is ensured by an injected one piece polyurethane gasket.

Lock:

Customized lock with double-bit for easy opening of the door. Double-bit 3 mm insert and 90° movement. Espagnolette three point locking. Other inserts are available as an accessory.

Mounting plate:

The mounting plate is marked vertically at 10 mm intervals, for easy horizontal positioning of equipment. On the top and bottom there are holes to facilitate cable fixing. Fixed onto M8 press welded studs to the rear of the enclosure. All sides, from 800 mm and above, are strengthened by folded edges. By using the AMG accessory, the mounting plate position can be adjusted to any depth.

Gland Plate Opening:

Situated at the far rear of the enclosure, to make cabling onto the mounting plate easier.

Protection:

IP 55 | TYPE 12 | IK 10. For outdoor installation, the use of a rain hood ARF and 100% polyester paint coating is recommended. The corrosion resistance must be taken into consideration.

Finish:

RAL 7035 structured powder coating.

Delivery:

Enclosure with doors and mounting plate (not included for item numbers ending with PER5). Two door mounting profiles on each door. Gland plate(s) with gasket(s), metallic double-bit 3 mm key, and mounting accessories. Earthing facilities.

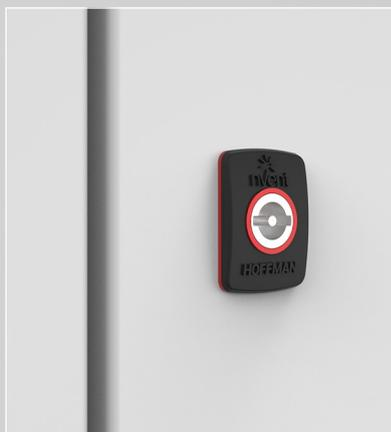

Dimensional table | MAD

IP 55 | TYPE 12 | IK 10

With mounting plate

Enclosure dimensions			Mounting plate dimensions		Usable depth	Gland plate			N° of locks	Item no.
H	W	D	h	w		Size	Type	Openings		
600	800	300	570	750	282	310 × 96	2	2	1*	MAD0608030R5
800	1200	300	770	1150	282	510 × 96	4	2	1*	MAD0801230R5
1000	1000	300	970	950	282	410 × 96	3	2	1*	MAD1001030R5
1200	1000	300	1170	950	282	410 × 96	3	2	1*	MAD1201030R5
1200	1200	300	1170	1150	282	510 × 96	4	2	1*	MAD1201230R5
1400	1000	300	1370	950	282	410 × 96	3	2	1*	MAD1401030R5

Without mounting plate

Enclosure dimensions			Gland plate			N° of locks	Item no.
H	W	D	Size	Type	Openings		
600	800	300	310 × 96	2	2	1*	MAD0608030PER5
800	1200	300	510 × 96	4	2	1*	MAD0801230PER5
1000	1000	300	410 × 96	3	2	1*	MAD1001030PER5
1200	1000	300	410 × 96	3	2	1*	MAD1201030PER5
1200	1200	300	510 × 96	4	2	1*	MAD1201230PER5
1400	1000	300	410 × 96	3	2	1*	MAD1401030PER5

* 3 point espagnolette locking.

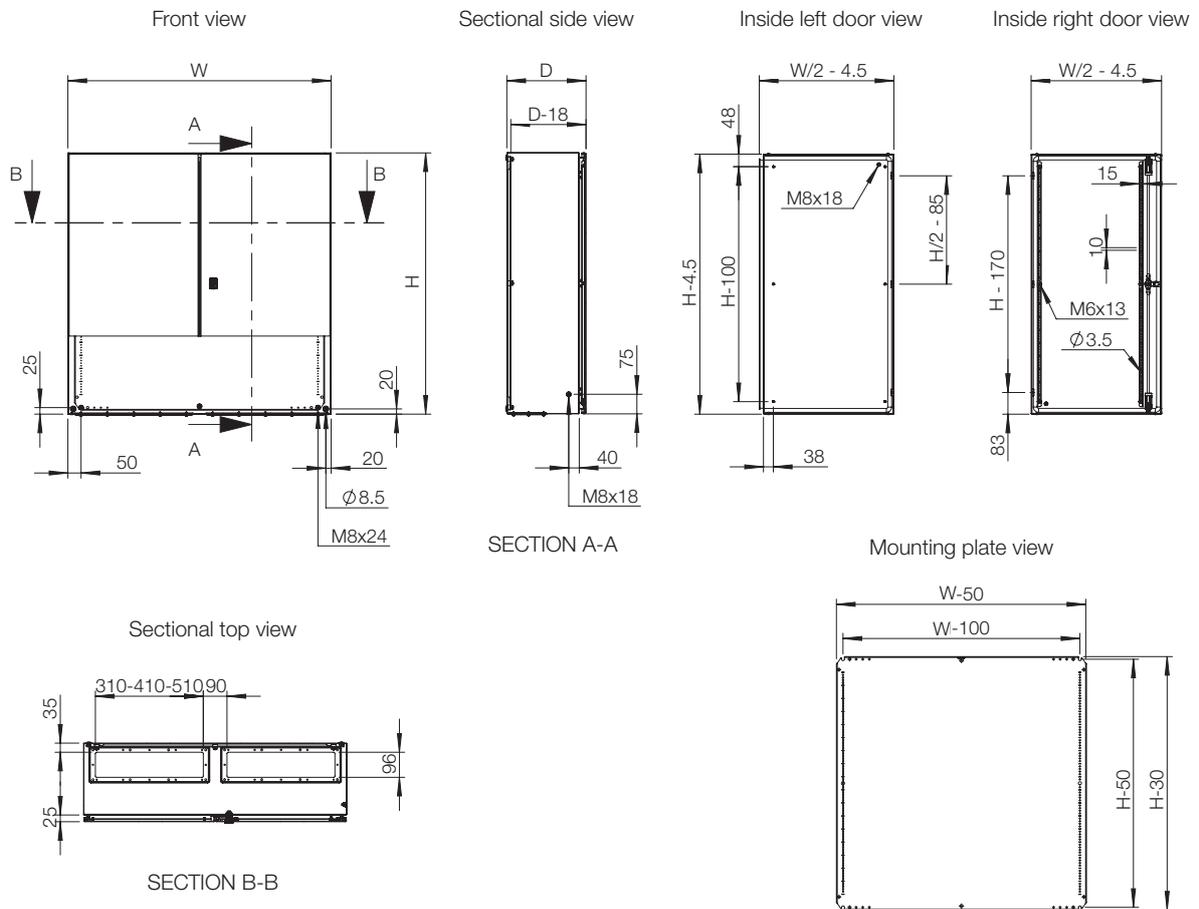

**Wall Mounted
Stainless Steel
Single door | ASR**

IP 66 | TYPE 4X, 12 | IK 10



Material:

AISI 304L / AISI 316L pre-grained stainless steel. Body: 1.5 mm. Door for AISI 304L: 1.5 mm / 2 mm for enclosures with a height or width of 600 mm or greater. Door for AISI 316L: 2 mm. Mounting plate: 2 mm galvanized steel.

Body:

Folded and seam welded.

Door:

Corner formed in one piece. Surface mounted, with 130° opening. Concealed AISI 304 stainless steel hinges with captive pin. Can be mounted to allow left or right hand opening. For AISI 316L, sealing is ensured by an injected one piece silicone gasket. Inner M6 welded studs, to mount door profiles MMDP.

Lock:

Eldon customized zamak double-bit 3 mm lock, with 90° movement and anti-vibration mechanism. 1000 mm high enclosures and above have espagnolette three point locking or 3 locks. Stainless steel lock and other versions are available as accessories.

Mounting plate:

The mounting plate is marked vertically at 10 mm intervals, for easy horizontal positioning of equipment. On the top and bottom there are holes to facilitate cable fixing. Fixed onto M8 press welded studs to the rear of the enclosure. All sides, from 800 mm and above, are strengthened by folded edges. By using the AMG accessory, the mounting plate position can be adjusted to any depth.

Cable access:

No gland plate openings as standard, to maximise sealing and cleanliness.

Protection:

Corresponds with IP 66 | TYPE 4X, 12 | IK 10.

Finish:

400 pre-grained stainless steel.

Delivery:

Enclosure with door, mounting plate, plastic double-bit 3 mm key, and mounting accessories. Metallic key, for height 1000 mm and above.

Additional information:

For outdoor environments, exposed to precipitation, the use of a rain hood is advised. Also in environments known for quick temperature changes, consideration to condensation should be taken. Please see the thermal management section.



Dimensional table | ASR

IP 66 | TYPE 4X, 12 | IK 10

With mounting plate

Enclosure dimensions			Mounting plate dimensions		Usable depth	N° of locks	Item no.
H	W	D	h	w	d		
240	240	150	210	190	132	1	ASR0242415
300	200	150	270	150	132	1	ASR0302015
300	200	150	270	150	132	1	ASR0302015-316
400	300	150	370	250	132	1	ASR0403015
400	300	210	370	250	192	1	ASR0403021
400	300	210	370	250	192	1	ASR0403021-316
400	400	210	370	350	192	1	ASR0404021
400	400	210	370	350	192	1	ASR0404021-316
400	600	210	370	550	192	1	ASR0406021
400	600	210	370	550	192	1	ASR0406021-316
500	400	210	470	350	192	1	ASR0504021
500	400	210	470	350	192	1	ASR0504021-316
500	500	210	470	450	192	1	ASR0505021
500	500	210	470	450	192	1	ASR0505021-316
600	400	210	570	350	192	2	ASR0604021
600	400	210	570	350	192	2	ASR0604021-316
600	600	210	570	550	192	2	ASR0606021
600	600	210	570	550	192	2	ASR0606021-316
600	600	300	570	550	282	2	ASR0606030
600	800	300	570	750	282	2	ASR0608030
800	600	210	770	550	192	2	ASR0806021
800	600	210	770	550	192	2	ASR0806021-316
800	600	300	770	550	282	2	ASR0806030
800	800	300	770	750	282	2	ASR0808030
800	800	300	770	750	282	2	ASR0808030-316
1000	800	300	970	750	282	1*	ASR1008030
1000	800	300	970	750	282	1*	ASR1008030-316
1200	800	300	1170	750	282	1*	ASR1208030
1200	800	300	1170	750	282	1*	ASR1208030-316
1400	800	400	1370	750	382	1*	ASR1408040

* 1000 mm high enclosures and above have espagnolette three point locking or 3 locks.

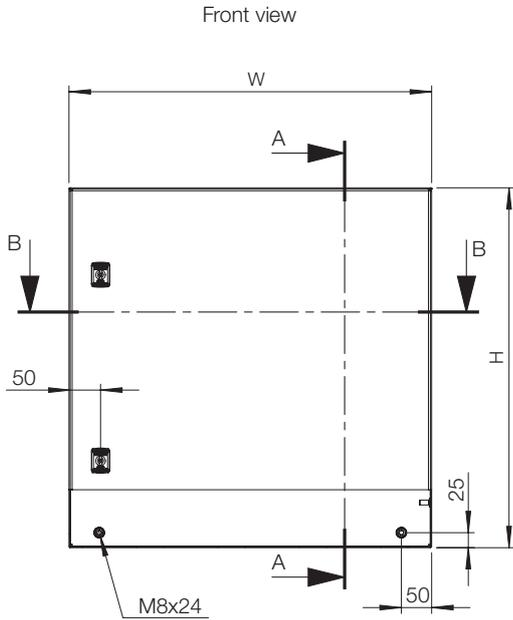

Sectional side view

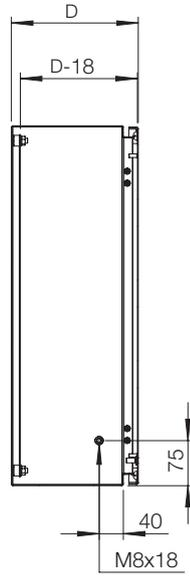

SECTION A-A

Inside door view

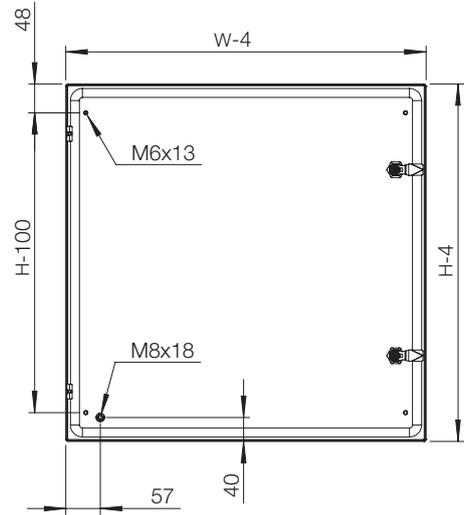

Sectional top view

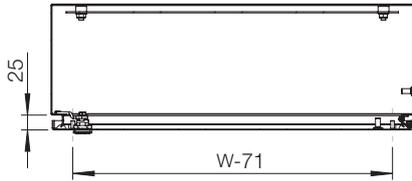

SECTION B-B

Mounting plate view

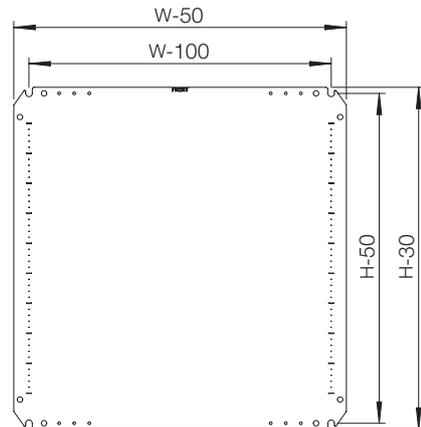

**Wall Mounted
Stainless Steel
Double door | ADR**

IP 55 | TYPE 12 | IK 10



02

Wall Mounted Enclosures

2

Material:

AISI 304L / AISI 316L pre-grained stainless steel. Body: 1.5 mm. Door: 2 mm.
Mounting plate: 2.5 mm galvanized steel.

Body:

Folded and seam welded. For ease of installation, each back corner of the enclosure is laser-marked to precisely indicate where to drill holes and affix AWS wall mounting brackets.

Door:

Corner formed in one piece. Surface mounted, with 130° opening. Concealed AISI 304 stainless steel hinges with captive pin. Inner M6 welded studs to mount door profiles MMDP. For AISI 316L, sealing is ensured by an injected one piece silicone gasket.

Lock:

nVent HOFFMAN customized zamak double-bit 3 mm lock, with 90° movement and anti-vibration mechanism. Espagnolette three point locking. Stainless steel lock and other versions are available as accessories.

Mounting plate:

The mounting plate is marked vertically at 10 mm intervals, for easy horizontal positioning of equipment. On the top and bottom there are holes to facilitate cable fixing. Fixed onto M8 press welded studs to the rear of the enclosure. All sides, from 800 mm and above, are strengthened by folded edges. By using the AMG accessory, the mounting plate position can be adjusted to any depth.

Cable access:

No gland plate openings as standard, to maximise sealing and cleanliness.

Finish:

400 pre-grained stainless steel.

Protection:

Corresponds with IP 55 | TYPE 12 | IK 10.

Delivery:

Enclosure with door, mounting plate, metallic key and mounting accessories.

Additional information:

For outdoor environments exposed to precipitation, the use of a rain hood is advised. Also in environments known for quick temperature changes, consideration to condensation should be taken. Please see the thermal management section.



Dimensional table | ADR

IP 55 | TYPE 12 | IK 10

With mounting plate

Enclosure dimensions			Mounting plate dimensions		Usable depth	N° of locks	Item no.
H	W	D	h	w	d		
1000	1000	300	970	950	282	1*	ADR1001030
1000	1000	300	970	950	282	1*	ADR1001030-316
1000	1200	300	970	1150	282	1*	ADR1001230
1000	1200	300	970	1150	282	1*	ADR1001230-316
1200	1200	400	1170	1150	382	1*	ADR1201240
1200	1200	400	1170	1150	382	1*	ADR1201240-316

* 3 point espagnolette locking.

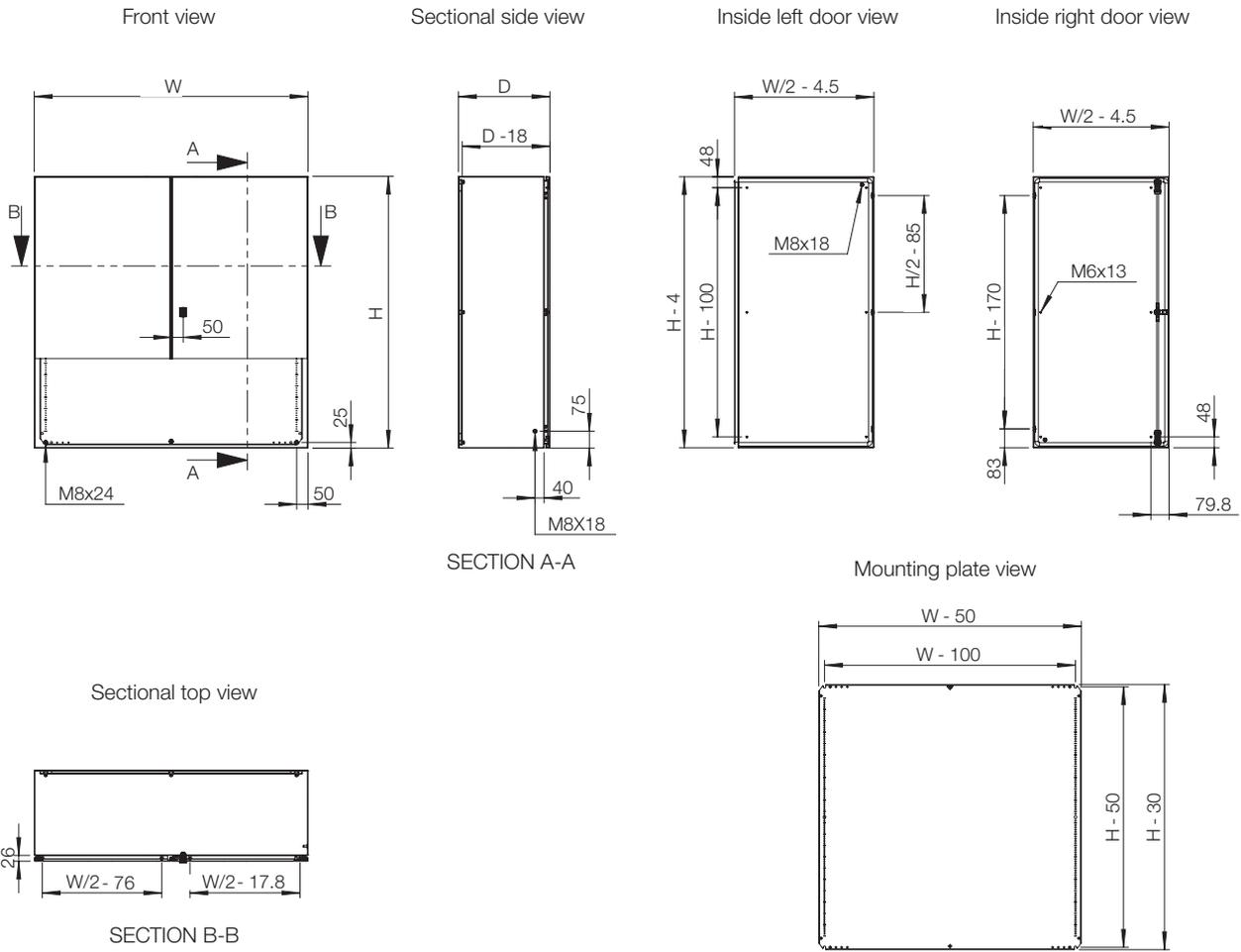

Wall Mounted

Accessories

Mounting plates, AMP

Description: Steel mounting plate for wall mounted enclosures. All sizes from 800 mm and above are strengthened by folded edges. By using the AMG accessory, the mounting plate position can be adjusted to any depth. This accessory is not suitable for the AFS range of enclosures, please refer to the replacement and spare parts catalogue.

Material: Galvanized steel.

Pack quantity: 1 piece.



For enclosure		Mounting plate dimensions		Item no.
H	W	h	w	
200	200	170	150	AMP02020
250	200	220	150	AMP02520
250	250	220	200	AMP02525
300	250	270	200	AMP03025
300	300	270	250	AMP03030
300	600	270	550	AMP03060
300	800	270	750	AMP03080
300	1000	270	950	AMP03100
300	1200	270	1150	AMP03120
350	250	320	200	AMP03525
400	300	370	250	AMP04030
400	400	370	350	AMP04040
400	500	370	450	AMP04050
400	600	370	550	AMP04060
500	300	470	250	AMP05030
500	400	470	350	AMP05040
500	500	470	450	AMP05050
600	400	570	350	AMP06040
600	500	570	450	AMP06050
600	600	570	550	AMP06060
600	800	570	750	AMP06080
700	500	670	450	AMP07050
800	400	770	350	AMP08040
800	600	770	550	AMP08060
800	800	770	750	AMP08080
800	1200	770	1150	AMP08120
1000	600	970	550	AMP10060
1000	800	970	750	AMP10080
1000	1000	970	950	AMP10100
1000	1200	970	950	AMP10120
1200	600	1170	550	AMP12060
1200	800	1170	750	AMP12080
1200	1000	1170	950	AMP12100
1200	1200	1170	1150	AMP12120
1400	1000	1370	950	AMP14100

Not suitable for AFS.

Insulated mounting plates, AMI

Description: Insulated mounting plate for wall mounted enclosures. By using the AMG accessory, the mounting plate position can be adjusted to any depth. This accessory is not suitable for the AFS range of enclosures, please refer to the replacement and spare parts catalogue.

Material: Bakelite.

Pack quantity: 1 piece.

For enclosure		Mounting plate dimensions			Item no.
H	W	h	w		
200	200	170	150	AMI02020	
250	200	220	150	AMI02520	
250	250	220	200	AMI02525	
300	250	270	200	AMI03025	
300	300	270	250	AMI03030	
400	300	370	250	AMI04030	
400	400	370	350	AMI04040	
400	600	370	550	AMI04060	
500	300	470	250	AMI05030	
500	400	470	350	AMI05040	
500	500	470	450	AMI05050	
600	400	570	350	AMI06040	
600	500	570	450	AMI06050	
600	600	570	550	AMI06060	
600	800	570	750	AMI06080	
700	500	670	450	AMI07050	
800	600	770	550	AMI08060	
1000	600	970	550	AMI10060	
1000	800	970	750	AMI10080	
1200	800	1170	750	AMI12080	

Not suitable for AFS.

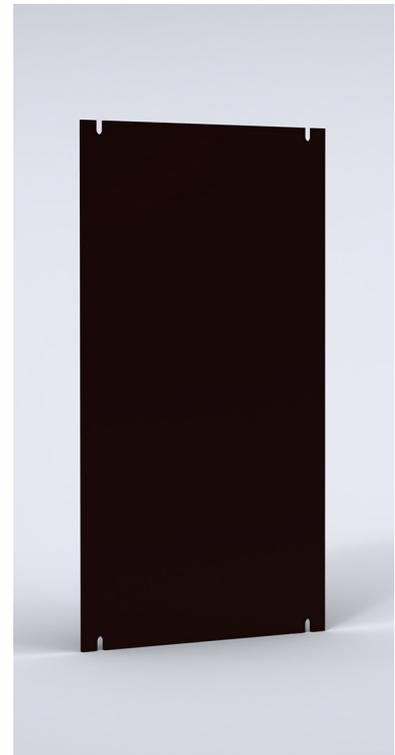

Wall Mounted

Accessories

Telequick mounting plate, AMT

Description: Steel mounting plate simplifies installation and equipment mounting. Rectangular holes 28 x 11 mm to obtain required fixing positions with snap nuts. The nuts can be moved around within the rectangular hole. By using the AMG accessory, the mounting plate position can be adjusted to any depth. This accessory is not suitable for the AFS range of enclosures, please refer to the replacement and spare parts catalogue.

Material: Galvanized steel.

Pack quantity: 1 piece.

For enclosure		Mounting plate dimensions		Item no.
H	W	h	w	
400	300	370	250	AMT04030
400	400	370	350	AMT04040
400	500	370	450	AMT04050
400	600	370	550	AMT04060
500	300	470	250	AMT05030
500	400	470	350	AMT05040
500	500	470	450	AMT05050
600	400	570	350	AMT06040
600	500	570	450	AMT06050
600	600	570	550	AMT06060
600	800	570	750	AMT06080
700	500	670	450	AMT07050
800	400	770	350	AMT08040
800	600	770	550	AMT08060
800	800	770	750	AMT08080
1000	600	970	550	AMT10060
1000	800	970	750	AMT10080
1200	800	1170	750	AMT12080

Not suitable for AFS.



Snap nuts for telequick plates, TN

Description: Nuts to be used in the telequick mounting plates.

Pack quantity: 50 pieces.

Thread	Item no.
M 4	TN04
M 5	TN05
M 6	TN06

Not suitable for AFS.

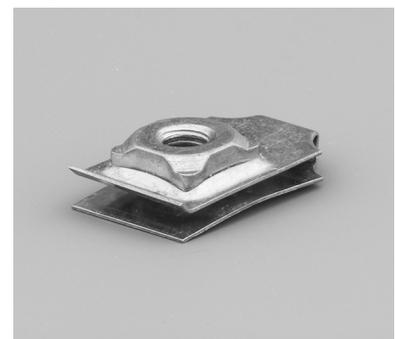

Depth adjustment kit, AMG

- Description:** To provide depth adjustment for different accessories: mounting plate, 19" profiles and inner door. In stainless steel enclosures machining is required.
- Material:** 2 mm galvanized steel.
- Depth adjustment:** Distance to the door D-35 to 65 mm.
- Pack quantity:** 2 pairs with mounting accessories.



For enclosure	
D	Item no.
155	AMG155
210	AMG210
260	AMG260
300	AMG300
400	AMG400

Not suitable for AFS.

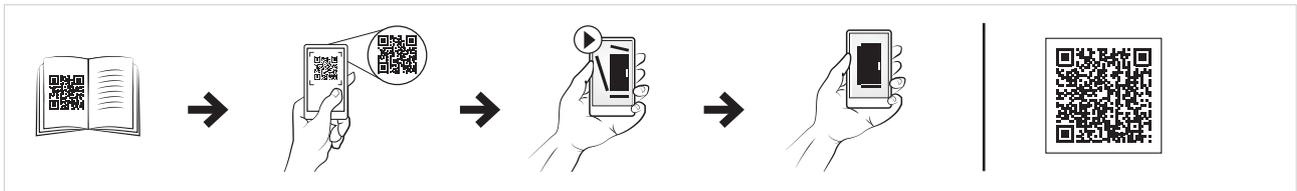

Depth adjustment bolts, AMTE

- Description:** For depth adjustment of the mounting plate. Metric thread M8.
- Material:** Zinc plated steel.

Length	Pack quantity	Item no.
10	50	AMTE8010
20	50	AMTE8020
30	50	AMTE8030
40	20	AMTE8040
50	20	AMTE8050
55	20	AMTE8055
100	20	AMTE8100



Wall Mounted

Accessories

Depth interior profile, DIP

Description: The DIP profile system is a 40 mm wide and 25 mm high profile, which can be mounted on the enclosure depth. It can also be used in combination with CLPF and CLPK profiles. Two rows of holes patterns for cage nut fixing and self-tapping screws are provided. DIP profiles are not compatible with adjustment in depth of the mounting plate.

Material: Zinc plated steel.

Pack quantity: 4 profiles including fixing accessories.



For enclosure		
D	Max. loading	Item no.
210	150 N	DIP210
260	150 N	DIP260
300	150 N	DIP300
400	150 N	DIP400

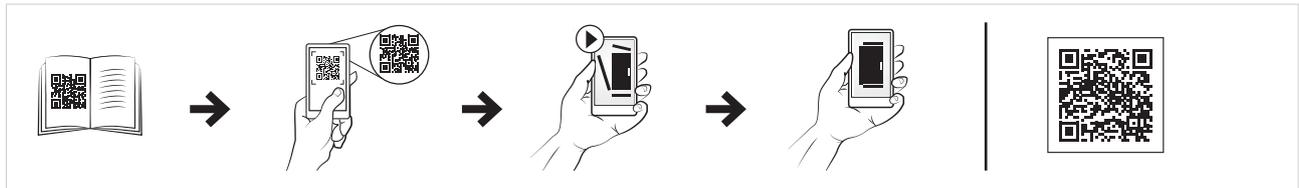

19" profiles, AVP

Description: For 600 mm wide enclosures only. Adjustable depth with the use of the AMG accessory. Usable depth between 19" profiles and external door: 56 mm. Fitted onto the hinge holes located on the front frame of the enclosure. For stainless steel enclosures, machining is required.

Material: 2 mm galvanized steel.

Pack quantity: 1 pair with mounting accessories.

For enclosure		
H	U	Item no.
600	13	AVP0600
800	17	AVP0800
1000	21	AVP1000
1200	26	AVP1200



Not suitable for AFS.

Vertical mounting profiles, AVB

Description: For the mounting of swing frames in full and partial height. The SFBP is mounted directly to the AVB. Equipped with 25 mm hole pattern. For other mounting purposes CNM cage nuts can be used. Fitted onto the hinge holes located on the front frame of the enclosure. For stainless steel enclosures, machining is required.

Material: 2 mm galvanized steel.

Pack quantity: 1 pair with mounting accessories.

For enclosure		Item no.
H		
600		AVB0600
800		AVB0800
1000		AVB1000
1200		AVB1200
1400		AVB1400

Not suitable for AFS.



Modular chassis, AC

Description: Used for easy mounting of DIN-rail components with a maximum height of 68 mm. Distance between rows 125 mm. If required, the standard enclosure door can be replaced with a glazed door. Usable depth between front cover and external door: 35 mm. In stainless steel enclosure machining is required.

Material: DIN-rails PP0735 made of 1.2 mm galvanized steel, vertical profiles 1.5 mm mild steel, and front cover 1.5 mm mild steel.

Finish: RAL 7035 structured powder coating.

Pack quantity: Slotted front panel, two vertical profiles, top and bottom blank panels, one DIN-rail per row, and mounting accessories.

Mounting requirements: To be assembled on MAS and ASR enclosures.

For enclosure				
H	W	N° of modules	N° of rows	Item no.
300	250	16	2	AC03025R5
400	300	33	3	AC04030R5
500	400	48	3	AC05040R5
600	400	64	4	AC06040R5
600	600	108	4	AC06060R5
700	500	110	5	AC07050R5
800	600	162	6	AC08060R5
1000	600	189	7	AC10060R5
1000	800	266	7	AC10080R5



Wall Mounted

Accessories

Enclosure pole fixation, EPF

- Description:** Accessory to fix enclosures onto poles. Maximum load of 900N.
- Material:** Galvanized steel.
- Minimum pole diameter:** 80 mm.
- Maximum pole diameter:** 250 mm.
- Pack quantity:** 2 profiles, 2 circular mounting strips for pole attachment and mounting accessories.



For Enclosure (W)		
MAS, MAD, ASR, ADR, AFS		Item no.
300		EPF0300
400		EPF0400
500		EPF0500
600		EPF0600
800		EPF0800

Front/rear plinths, P

- Description:** Four corner pieces with removable front covers. The side panels PA must be ordered separately. Available heights: 100 and 200 mm. Machining is required.
- Material:** 2.5 mm mild steel for corner pieces and 1.5 mm mild steel for covers.
- Finish:** RAL 7022 structured powder coating.
- Pack quantity:** 4 corner pieces and 2 front covers, with mounting accessories.



Plinth Height	For enclosure		Item no.
	Width		
100	400		P1040
100	500		P1050
100	600		P1060
100	800		P1080
100	1000		P1100
100	1200		P1120
200	400		P2040
200	500		P2050
200	600		P2060
200	800		P2080
200	1000		P2100
200	1200		P2120

Side plinths, PA

Description:	Side covers for plinth P, strengthened by folded edges.
Material:	1.5 mm mild steel.
Finish:	RAL 7022 structured powder coating.
Pack quantity:	2 pieces for height 100 mm and 4 pieces for height 200 mm.

Plinth	For enclosure	
Height	Depth	Item no.
100	260	PA1026
100	300	PA1030
100	400	PA1040
200	260	PA2026
200	300	PA2030
200	400	PA2040



2

Floor stands, PFF

Description:	Floor stands for floor mounting to give a suitable operation height. Available for 300 and 400 mm depth enclosures with $W \geq 400$ mm. 300 or 450 mm high are available. Machining is required.
Material:	2 mm mild steel.
Finish:	RAL 7035 structured powder coating.
Pack quantity:	2 pieces with mounting accessories.

Plinth	For enclosure	
Height	Depth	Item no.
300	300	PFF330R5
450	300	PFF345R5
300	400	PFF430R5
450	400	PFF445R5

Not suitable for AFS.



Wall Mounted

Accessories

Transparent doors, ADT

- Description:** To replace the standard door, it provides a clear view of the components installed inside the enclosure. The lock(s) are interchangeable with all nVent HOFFMAN's standard lock(s).
- Material:** 1.2 mm mild steel / 1.5 mm for enclosures with a height or width of 500 mm or greater / 2 mm for enclosures with a height or width of 800 mm or greater and 3 mm transparent acrylic glass.
- Finish:** RAL 7035 structured powder coating.
- Protection:** Complies with IP55, IK 07.
- Pack quantity:** 1 door.



For enclosure		Viewing area		N° of locks	Item no.
H	W	h	w		
300	250	159	93	1	ADT03025R5
300	300	159	143	1	ADT03030R5
400	300	259	143	1	ADT04030R5
400	400	259	243	1	ADT04040R5
500	300	359	143	1	ADT05030R5
500	400	359	243	1	ADT05040R5
600	400	459	243	2	ADT06040R5
600	500	459	343	2	ADT06050R5
600	600	459	443	2	ADT06060R5
700	500	559	343	2	ADT07050R5
800	600	659	443	2	ADT08060R5
1000	600	859	427	1*	ADT10060R5
1000	800	859	627	1*	ADT10080R5
1200	600	1059	427	1*	ADT12060R5
1200	800	1059	627	1*	ADT12080R5

* 3 point espagnolette locking.
Not suitable for AFS.

Glazed doors, ADC

Description:	To replace the standard door, it provides a clear view of the components installed inside the enclosure. The lock(s) are interchangeable with all nVent HOFFMAN's standard lock(s).
Material:	1.2 mm mild steel / 1.5 mm for enclosures with a height or width of 500 mm or greater / 2 mm for enclosures with a height or width of 800 mm or greater and 4 mm clear safety glass.
Finish:	RAL 7035 structured powder coating.
Protection:	Complies with IP 55 TYPE 12, IK 07.
Pack quantity:	1 door.

For enclosure		Viewing area		N° of locks	Item no.
H	W	h	w		
300	250	159	93	1	ADC03025R5
300	300	159	143	1	ADC03030R5
400	300	259	143	1	ADC04030R5
400	400	259	243	1	ADC04040R5
500	300	359	143	1	ADC05030R5
500	400	359	243	1	ADC05040R5
600	400	459	243	2	ADC06040R5
600	500	459	343	2	ADC06050R5
600	600	459	443	2	ADC06060R5
700	500	559	343	2	ADC07050R5
800	600	659	443	2	ADC08060R5
1000	600	859	427	1*	ADC10060R5
1000	800	859	627	1*	ADC10080R5
1200	600	1059	427	1*	ADC12060R5
1200	800	1059	627	1*	ADC12080R5

* 3 point espagnolette locking.
Not suitable for AFS.



Wall Mounted

Accessories

Wall mounting brackets, AW

Description: Mounting brackets for safe wall fixing. It includes the sealing washers to guarantee the IP rating.

Material: 3 mm zinc plated steel.

Pack quantity: 4 brackets with mounting accessories.

Item no.
AW41

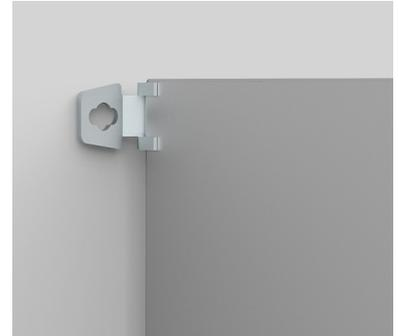

Wall mounting brackets, AWS

Description: Mounting brackets for safe wall fixing. It includes the sealing washers to guarantee the IP rating. In stainless steel machining is required.

Pack quantity: 4 brackets with mounting accessories.

Material	Item no.
3 mm stainless steel 304	AWS41-304
3 mm stainless steel 316	AWS41-316

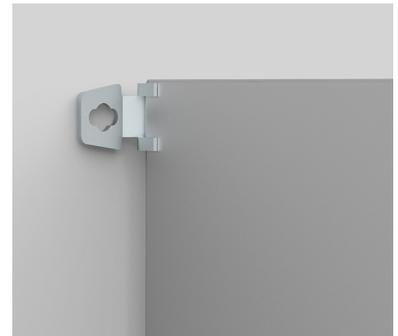

Inner doors, ADI

Description:	For controls, meters, lamps, etc. Hinges can be mounted to allow left or right hand opening. Lock double-bit 3 mm insert; 700 mm high doors and above have 2 locks. Usable depth between inner and external door: 35 mm. Adjustable depth position with AMG accessory. Workable area: H-55, W- 108. 19" version available on request. Machining is required for stainless steel enclosures.
Material:	Door 1.5 mm mild steel, vertical top and bottom profiles 2 mm mild steel.
Finish:	RAL 7035 structured powder coating.
Protection:	IP 2XC.
Pack quantity:	Inner door, two vertical profiles, top and bottom profiles and mounting accessories.



2

For enclosure		Inner door dimensions			
H	W	h	w	N° of locks	Item no.
400	300	345	192	1	ADI04030R5
400	400	345	292	1	ADI04040R5
400	500	345	392	1	ADI04050R5
400	600	345	492	1	ADI04060R5
500	300	445	192	1	ADI05030R5
500	400	445	292	1	ADI05040R5
500	500	445	392	1	ADI05050R5
600	400	545	292	1	ADI06040R5
600	500	545	392	1	ADI06050R5
600	600	545	492	1	ADI06060R5
600	800	545	692	1	ADI06080R5
700	500	645	392	2	ADI07050R5
800	400	745	292	2	ADI08040R5
800	600	745	492	2	ADI08060R5
800	800	745	692	2	ADI08080R5
1000	600	945	492	2	ADI10060R5
1000	800	945	692	2	ADI10080R5
1200	600	1145	492	2	ADI12060R5
1200	800	1145	692	2	ADI12080R5

Not suitable for AFS.

Wall Mounted

Accessories

180° Hinges, MMH

Description: Door hinges that allow the door to open 180°. Machining is not required.

Material: Zamak.

Pack quantity: MMH02 - 2 pcs. MMH03 - 3 pcs.



For enclosure	
H	Item no.
≤ 800mm	MMH02
> 800mm	MMH03

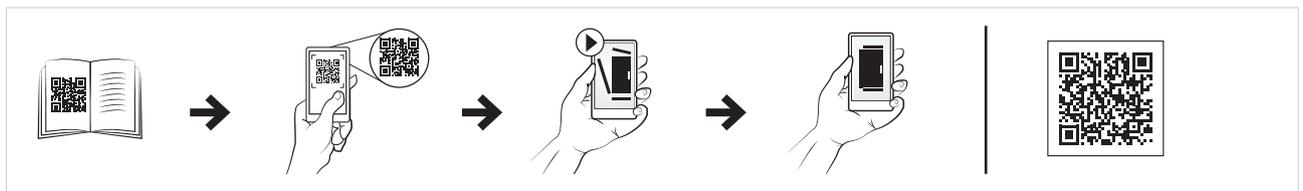

180° Hinges, MMHS

Description: Door hinges that allow the door to open 180°. Machining is not required.

Material: Stainless steel 316.

Pack quantity: MMHS02 - 2 pcs. MMHS03 - 3 pcs.



For enclosure	
H	Item no.
≤ 800mm	MMHS02
> 800mm	MMHS03

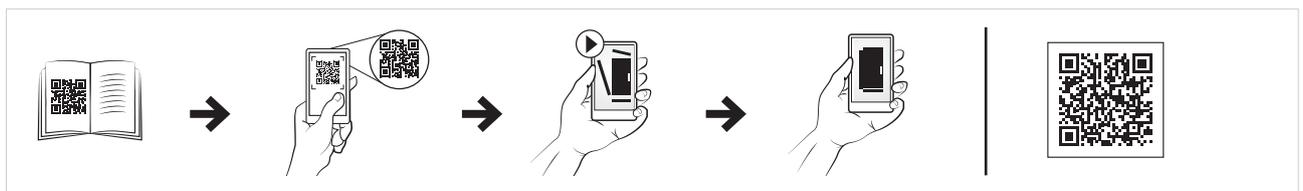

Door stop, ADO

Description: Door stop to fit all wall mounted enclosure dimensions. To secure the door in an open position to the degree that meets user requirements. Door stop can be mounted at the top or bottom of the enclosure. Machining is required. Minimum enclosure width ≥ 300 mm.

Pack quantity: 1 piece with mounting accessories.

Material	Item no.
3 mm thick zinc plated steel	ADO202
2.5 mm stainless steel AISI 316L	ADO202S

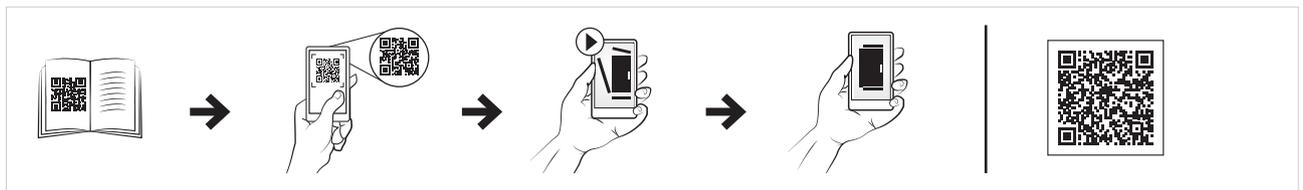

Door switch, ADSW

Description: Door switch to activate any electrical device (lighting, signalling, alarms, etc.) designed for wall mounted enclosures. Cable entry M20. In stainless steel enclosures, machining is required.

Switch capacity: 3 A / 240 V.

Approvals: CE, EAC, cULus listed.

Pack quantity: 1 piece with mounting accessories.

Item no.
ADSW01

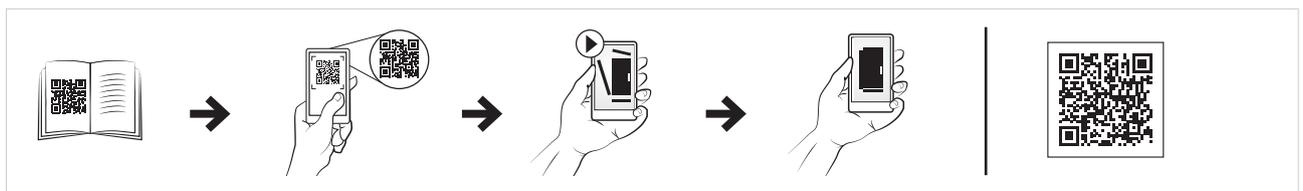

Wall Mounted

Accessories

Door mounting profiles, MMDP

- Description:** To strengthen the door and provide further mounting possibilities. Mounted on the inside of the door onto M6 welded studs. Equipped with a 10 mm hole pattern. These door profiles cannot be used with the AFS enclosure range.
- Material:** 1.2 mm galvanized steel.
- Dimension:** 15 x 14 mm.
- Pack quantity:** 1 pair with mounting accessories.

For enclosure	
H	Item no.
400	MMDP040
500	MMDP050
600	MMDP060
700	MMDP070
800	MMDP080
1000	MMDP100
1200	MMDP120
1400	MMDP140

Not suitable for AFS.



Door horizontal profiles, DHP

- Description:** Horizontal profiles with 25 mm hole pattern of 4.5 mm and 6.5 mm of diameter for the attachment and installation of equipment.
- Material:** 1.5 mm galvanized steel.
- Pack quantity:** 5 pieces with mounting accessories.
- Mounting requirements:** They fit directly onto the MMDP door mounting profiles. They can also be mounted vertically onto two horizontal profiles. For doors with espagnolette locking system, profiles must be cut where indicated.

For enclosure	
W	Item no.
300	DHP030
400	DHP040
500	DHP050
600	DHP060
800	DHP080

Not suitable for AFS.

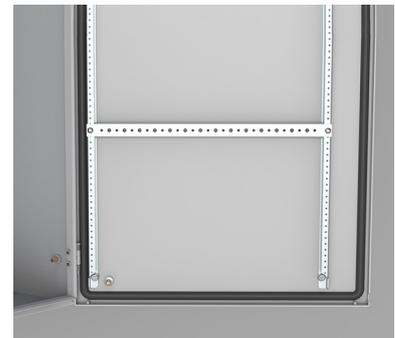

Inserts, ALIS

Description: Inserts to replace the standard double-bit 3 mm insert in the standard ALLS503N lock.

Material: Zamak chrome plated.

Pack quantity: 1 piece.

Description	Item no.
Slotted 2x4 mm	ALIS528

Not suitable for AFS.



Locks, ALL

Description: Alternative locks to replace the standard one.

Pack quantity: 1 piece.

Description	Type	Protection	Compatibility	Item no.
Plastic	DIN 3 mm	IP 66		ALL503N
ADA lock with cylinder	Ronis key n° C21323	IP 65	ADA	ALL506
ADAB lock with cylinder	Ronis key n° C21323	IP 65	ADAB	ALL507
Chrome plated lock with cylinder	Ronis key n° M21323	IP 65		ALL508
Polyamide lock with cylinder	Key 5333	IP 55		ALL509
Lock with cylinder	Ronis key n° C21323	IP 65		ALL510N

Not suitable for AFS.



Double-bit 3 mm stainless steel locks, ALLS

Description: Stainless steel double-bit 3 mm lock.

Pack quantity: 1 piece.

Description	Protection	Item no.
AISI 304 stainless steel	IP 65	ALLS304
AISI 316L stainless steel	IP 66	ALLS316
Chrome plated Zamak	IP 66	ALLS503N



Wall Mounted

Accessories

Padlocking, PLC

Description: The padlocking cover is mounted over the existing standard lock. The standard lock is totally covered and not accessible when padlock is fitted. Maximum padlock bow diameter of 10 mm.

Material: Stainless steel.

Pack quantity: 1 piece.

Item no.
PLC01

Not suitable for AFS.



Handles, ALT

Description: Alternative handles to replace the standard lock.

Pack quantity: 1 piece.

Description	Protection	Item no.
Plastic handle	IP 66	ALT560
Chrome plated T-handle with cylinder lock, key M21323	IP 65	ALT561
Chrome plated handle with cylinder lock, key M21323	IP 65	ALT562
Plastic handle with cylinder lock, Key 5333	IP 65	ALT563

Other locking options available, please contact our sales representative. Not suitable for AFS.



Keys, LSK

Description: Key with nVent HOFFMAN logo. Easy to use design, providing a good grip.

Pack quantity: 1 piece.

Description	Material	Item no.
Double-bit 3 mm	Plastic	LSK502
Double-bit 3 mm	Metalic	LSK503
Double-bit 5 mm	Metalic	LSK505
Square 7 mm	Metalic	LSK523
Square 8 mm	Metalic	LSK524
Triangle 7 mm	Metalic	LSK526
Triangle 8 mm	Metalic	LSK527



Wall mounted combining kit, CK

- Description:** Wall mounting combining kit is to be used for buying two or more wall mounted enclosures together, side by side. This enables customers to create many more enclosure configurations than previously available.
- Material:** EPDM rubber 10 mm thick.
- Pack quantity:** Combining kit provided in a puzzle format, along with mounting accessories.

Item no.
CK01

Not suitable for AFS.

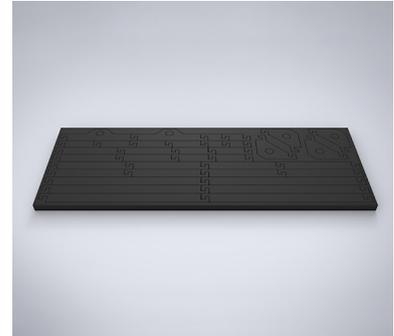

Gland plate combining gaskets, AGC

- Description:** To be used when a wall mounted enclosures combination (MAS/MAD) is needed. Combining gaskets are to be used to buy gland plate openings together.
- Material:** 8 mm polyethylene foam.
- Pack quantity:** 2 pieces, and combination mounting accessories.

For opening	Gland plate type	Item no.
310 x 96	2	AGC02
410 x 96	3	AGC03
510 x 96	4	AGC04



Lifting eyes, AL

- Description:** M12 thread. Complies with DIN 580 lifting requirements. Machining is required.
- Material:** Steel.
- Pack quantity:** 2 eye-bolts, 2 reinforcements and mounting accessories.

Item no.
AL9301

Not suitable for AFS.



Wall Mounted

Accessories

Standard gland plates, AF

Description: Gland plates for the standard gland opening.

Material: 1.4 mm mild steel.

Finish: RAL 7035 structured powder coating.

Pack quantity: 1 piece.

For opening	Gland plate type	Item no.
110 x 56	0S	AF00SR5
210 x 56	1S	AF01SR5
310 x 56	2S	AF02SR5
410 x 56	3S	AF03SR5
210 x 96	1	AF01R5
310 x 96	2	AF02R5
410 x 96	3	AF03R5
510 x 96	4	AF04R5



Gland plate gaskets, AG

Description: For standard gland plate opening.

Material: 4 mm polyethylene foam.

Pack quantity: 1 piece.

For opening	Gland plate type	Item no.
110 x 56	0S	AG00S
210 x 56	1S	AG01S
310 x 56	2S	AG02S
410 x 56	3S	AG03S
210 x 96	1	AG01
310 x 96	2	AG02
410 x 96	3	AG03
510 x 96	4	AG04



Ventilated gland plates, AFR

Description:	Louvered plate, pressed out 5 mm.
Material:	1.4 mm mild steel.
Finish:	RAL 7035 structured powder coating.
Protection:	Complies with IP 23, in bottom or vertical position.
Pack quantity:	1 piece.

For opening	Gland plate type	Item no.
210 x 96	1	AFR01R5
310 x 96	2	AFR02R5
410 x 96	3	AFR03R5
510 x 96	4	AFR04R5



Ventilated gland plates with filter, AFV

Description:	Louvered plate, pressed out 5 mm with filter.
Material:	1.4 mm mild steel.
Finish:	RAL 7035 structured powder coating.
Protection:	Complies with IP 53, in bottom or vertical position.
Pack quantity:	1 piece.

For opening	Gland plate type	Item no.
210 x 96	1	AFV01R5
310 x 96	2	AFV02R5
410 x 96	3	AFV03R5
510 x 96	4	AFV04R5



Adapter gland plates, AFA

Description:	Adapts FL gland plates to the wall mounted, steel enclosures gland opening.
Material:	1.4 mm mild steel.
Finish:	RAL 7035 structured powder coating.
Pack quantity:	1 piece.

For opening	N° of FL openings	Gland plate type	Item no.
210 x 96	1xFL13	1	AFA01R5
310 x 96	1xFL21	2	AFA02R5
410 x 96	1xFL21	3	AFA03R5
510 x 96	2xFL21	4	AFA04R5



Wall Mounted

Accessories

Gland plates with knock-outs, AFK

- Description:** Gland plates with knock-outs according to table.
- Material:** 1.4 mm mild steel.
- Finish:** RAL 7035 structured powder coating.
- Pack quantity:** 1 piece.

For opening	M16	M20	M25	M32	Gland plate type	Item no.
210 x 56	4	3	–	–	1S	AFK11SR5
310 x 56	6	3	1	–	2S	AFK21SR5
410 x 56	9	4	1	–	3S	AFK31SR5
210 x 96	4	5	2	2	1	AFK11R5
210 x 96	12	–	1	1	1	AFK12R5
310 x 96	9	5	4	2	2	AFK21R5
310 x 96	21	–	1	1	2	AFK22R5
410 x 96	18	5	4	2	3	AFK31R5
410 x 96	21	10	–	–	3	AFK32R5
510 x 96	27	5	4	2	4	AFK41R5
510 x 96	18	14	3	1	4	AFK42R5



Plastic cable plates, EHTC

- Description:** Gland plates suitable for leading through cables as well as different types of tubing. To be installed directly to the adapter gland plate AFA. Please see the cable management section.
- Material:** Different types of polymers reinforced with a steel plate. Halogen free and UV resistant.
- Protection:** IP 65.
- Finish:** RAL 7035.
- Pack quantity:** 1 piece with mounting accessories.

For opening	Item no.
FL21	EHTC2125G
FL21	EHTC213G
FL21	EHTC2135G
FL21	EHTC2150G



Rain hood, ARF

- Description:** To be fitted as an outdoor shelter on single mounted enclosures. The roof is slightly sloped and has a dripstrip. Machining is required. It increases the enclosure dimension in H:60 mm, D:20 mm and W:20 mm.
- Material:** 1.5 mm mild steel.
- Finish:** RAL 7035 structured powder coating.
- Pack quantity:** 1 rain hood with mounting accessories.
- Additional information:** If the rain hood is exposed to high levels of UV radiation, the ARF should be coated with 100% polyester paint. This can be ordered as a special accessory. The ARF is not compatible with 180° MMH hinges.



For enclosure		
W	D	Item no.
250	155	ARF02515R5
250	210	ARF02521R5
300	155	ARF03015R5
300	210	ARF03021R5
400	155	ARF04015R5
400	210	ARF04021R5
400	260	ARF04026R5
400	300	ARF04030R5
500	155	ARF05015R5
500	210	ARF05021R5
500	260	ARF05026R5
500	300	ARF05030R5
600	210	ARF06021R5
600	260	ARF06026R5
600	300	ARF06030R5
600	400	ARF06040R5
800	210	ARF08021R5
800	260	ARF08026R5
800	300	ARF08030R5
800	400	ARF08040R5
1000	300	ARF10030R5
1200	300	ARF12030R5

Not suitable for AFS.

Terminal Boxes

Mild Steel

Mild steel terminal box | STB

IP 66 | TYPE 4, 12 | IK 08

Material:

1.2 mm mild steel.

Body:

Folded and seam welded. Four 8.5 mm diameter holes for wall fixing. Four M6 × 13 studs for bottom profiles / mounting plate fixation.

Gasket:

Sealing is ensured by an injected one piece polyurethane gasket.

Earthing:

M8x18 mm earthing studs in body and cover, M8 nuts, earthing washers and earthing labels.

Protection:

IP 66 | TYPE 4, 12 | IK 08.

Finish:

RAL 7035, structured powder coating.

Delivery:

Body, cover, cover screws, fixing screws, cover plugs, and earthing facilities.



IP 66 | TYPE 4, 12 | IK 08

H	Box dimension			Weight (kg)	Item no.
	W	D			
150	150	80		1.15	STB151508
150	150	120		1.35	STB151512
150	300	80		1.90	STB153008
150	300	120		2.25	STB153012
200	200	80		1.70	STB202008
200	200	120		2.00	STB202012
200	300	80		2.35	STB203008
200	300	120		2.75	STB203012
200	400	80		2.90	STB204008
200	400	120		3.35	STB204012
200	500	120		4.10	STB205012
200	600	120		4.75	STB206012
200	800	120		6.30	STB208012
300	300	80		3.15	STB303008
300	300	120		3.55	STB303012
300	400	120		4.50	STB304012
300	500	120		5.40	STB305012
300	600	120		6.40	STB306012
400	400	120		5.85	STB404012
400	600	120		7.80	STB406012
400	800	120		9.90	STB408012



Dimensional drawing | STB

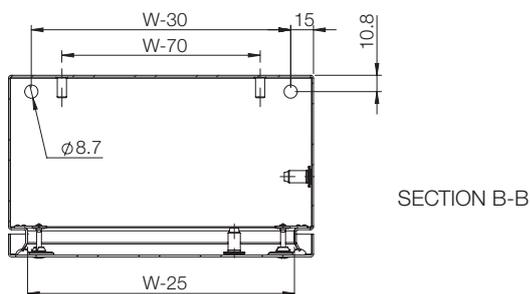
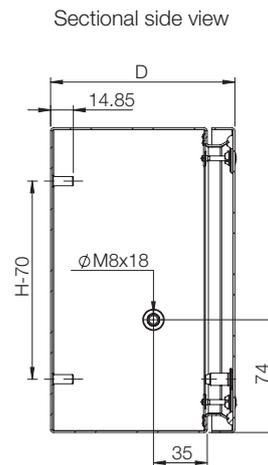
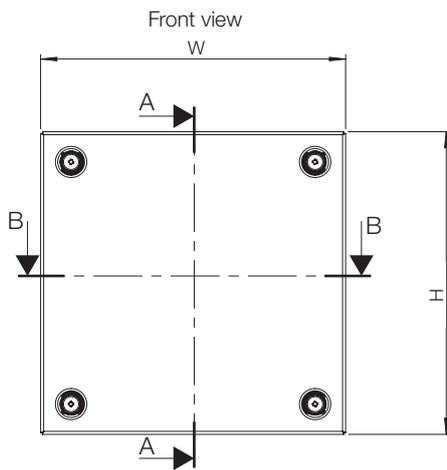

Terminal Boxes

Stainless Steel

Stainless steel terminal box | SSTB

IP 66 | TYPE 4X, 12 | IK 08

Material:

AISI 304L pre-grained stainless steel / AISI 316L (on request).
Body: 1 mm. Cover: 1.5 mm.

Body:

Folded and seam welded. Four M6x13 studs for bottom profile / mounting plate fixation.

Gasket:

For AISI 316L, sealing is ensured by an injected one piece silicone gasket.

Earthing:

M8x18 mm earthing studs in body and cover, M8 nuts, earthing washers and earthing labels.

Protection:

IP 66 | TYPE 4X, 12 | IK 08.

Finish:

400 pre-grained stainless steel.

Delivery:

Body, cover, cover screws, fixing screws, cover plugs and earthing facilities.



IP 66 | TYPE 4X, 12 | IK 08

H	Box dimension		Weight (kg)	Item no.
	W	D		
150	150	80	1.10	SSTB151508
150	150	120	1.30	SSTB151512
150	300	80	1.80	SSTB153008
150	300	120	2.15	SSTB153012
200	200	80	1.65	SSTB202008
200	200	120	1.95	SSTB202012
200	300	80	2.25	SSTB203008
200	300	120	2.55	SSTB203012
200	400	80	2.80	SSTB204008
200	400	120	3.20	SSTB204012
200	500	120	3.90	SSTB205012
200	600	120	4.60	SSTB206012
200	800	120	5.90	SSTB208012
300	300	80	3.05	SSTB303008
300	300	120	3.40	SSTB303012
300	400	120	4.25	SSTB304012
300	500	120	5.10	SSTB305012
300	600	120	6.10	SSTB306012
400	400	120	5.50	SSTB404012
400	600	120	7.65	SSTB406012
400	800	120	9.70	SSTB408012

Dimensional drawing | SSTB

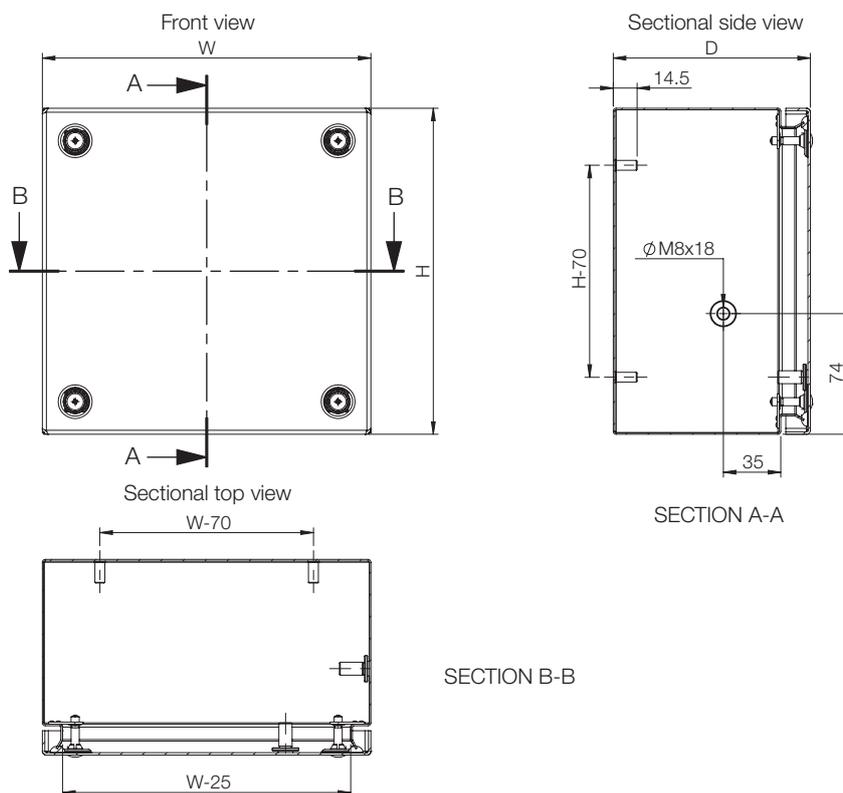

Terminal Boxes

Accessories

Mounting plate, BMP

Description: Steel mounting plate for terminal boxes.

Material: 2 mm galvanized steel.

Pack quantity: 1 piece.

Box dimension		Mounting plate dimensions		Item no.
H	W	h	w	
150	150	125	120	BMP1515
150	300	125	270	BMP1530
200	200	175	170	BMP2020
200	300	175	270	BMP2030
200	400	175	370	BMP2040
200	500	175	470	BMP2050
200	600	180	570	BMP2060
200	800	180	770	BMP2080
300	300	275	270	BMP3030
300	400	275	370	BMP3040
300	500	275	470	BMP3050
300	600	280	570	BMP3060
400	400	375	370	BMP4040
400	600	380	570	BMP4060
400	800	380	770	BMP4080



Spacer bolts for terminal boxes, AMTE

Description: For depth adjustment of the mounting plate. Metric thread M6.

Material: Zinc plated steel.

Length	Pack quantity	Item no.
10	50	AMTE6010
20	50	AMTE6020
30	50	AMTE6030
40	20	AMTE6040
50	20	AMTE6050



Bottom profile, BPP

Description: Bottom profile for DIN rail mounting.

Material: Galvanized steel.

Pack quantity: 2 pieces.

For box	
H/W	Item no.
150	BPP15
200	BPP20
300	BPP30
400	BPP40
500	BPP50
600	BPP60
800	BPP80



DIN rail, BDR

Description: DIN rail 35 mm for terminal boxes.

Material: Galvanized steel.

Pack quantity: 5 pieces.

For box	
H/W	Item no.
150	BDR3515
200	BDR3520
300	BDR3530
400	BDR3540
500	BDR3550
600	BDR3560
800	BDR3580



Terminal Boxes

Accessories

Hinges, STBH

Description: Using this accessory the cover can be hinged. Machining is required.

Material: Zinc plated steel.

Pack quantity: Set of 2 hinges with mounting accessories.

Item no.
STBH02



Hinges, SSTBH

Description: Using this accessory the cover can be hinged. Machining is required.

Material: Stainless steel.

Pack quantity: Set of 2 hinges with mounting accessories.

Item no.
SSTBH02



Our powerful portfolio of brands:

CADDY ERICO HOFFMAN RAYCHEM SCHROFF TRACER



hoffman.nVent.com