

16 15 14 13 12 11 10 9 8 7 6 5 4 3 2 1

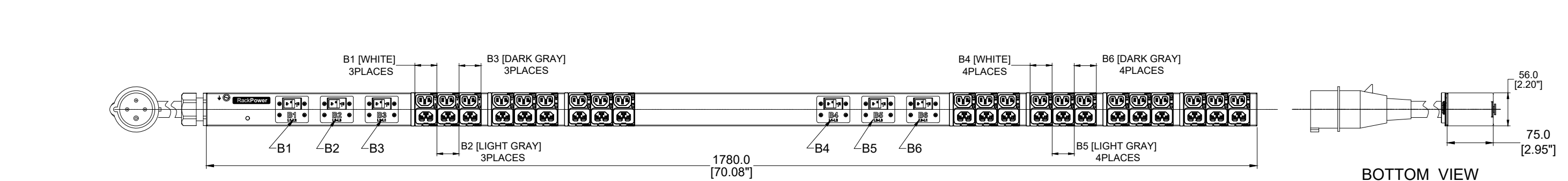
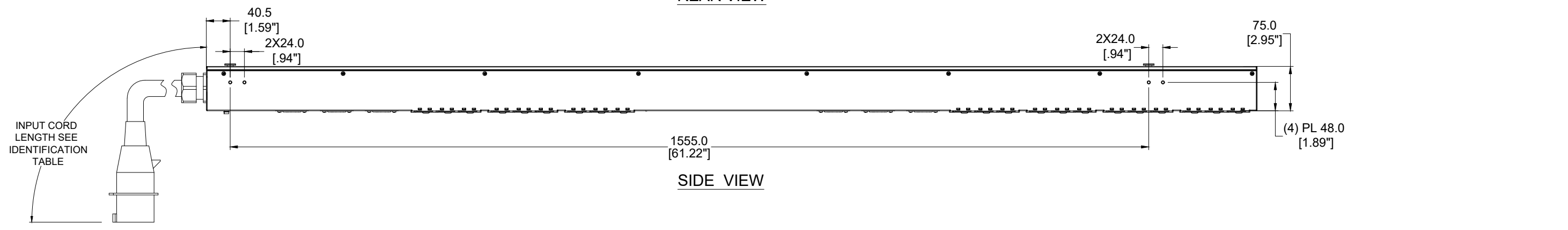
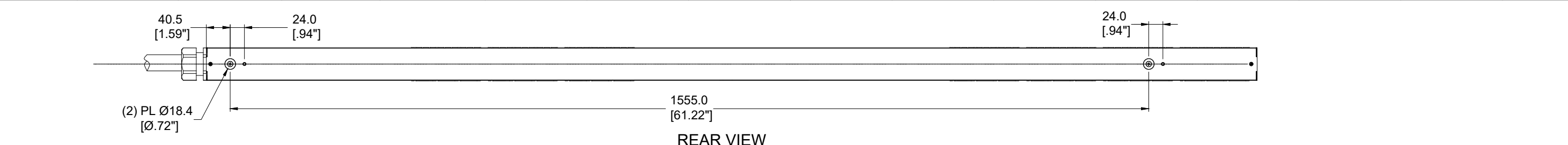

TECHNICAL SPECIFICATIONS	
UNIT TYPE:	BASIC
ORIENTATION:	VERTICAL, 0U FULL
OUTLET QTY & TYPE:	(21)C13/C15, (21)C13/C15/C19
INPUT VOLTAGE:	208VAC
INPUT CURRENT:	60A (48A DERATED)
BREAKER QTY & TYPE:	(6) 20AMP, DOUBLE-POLE
INPUT PHASE:	THREE-PHASE, DELTA
RATED POWER:	17.3 KVA
INPUT PLUG:	SEE NOTE 7
INPUT POWER CORD:	SEE IDENTIFICATION TABLE
FEATURES	
METERING ACCURACY	+/-1% TO ISO/ IEC 62052-21
METERING ATTRIBUTES	VOLTAGE(V), CURRENT(A), APPARENT POWER(kVA), REAL POWER(kW), POWER FACTOR, ENERGY(kWh)
METERED COMPONENTS	N/A
REMOTE OUTLET SWITCHING	N/A
ENVIRONMENTAL CONDITIONS	
OPERATING TEMPERATURE	-5 TO 60 C (23 TO 140 F)
STORAGE TEMPERATURE	-20 TO 60 C (-4 TO 140 F)
HUMIDITY (OPERATING/STORAGE)	5-90% RH / 5-95% RH; NON-CONDENSING
MAX OPERATING ELEVATION, ABOVE MSL	3000M(9840FT)
COMPLIANCE	
SAFETY&ENVIRONMENTAL	RoHS COMPLIANT

IDENTIFICATION TABLE	RB 0952	*	*	*	*
MODEL IS SHOWN IN DEFAULT CONFIGURATION. FOR OPTIONAL CONFIGURATIONS, USE ITEM IDENTIFIER CODE IN PLACE OF EACH ASTERISK. ORDERABLE BASED ON FORMAT: RB0952 **** DO NOT INCLUDE TRAILING ZEROS IN **** SUFFIX	INPUT PLUG	CHASSIS COLOR	CORD OPTION	ORIENTATION	
	(DEFAULT) 460P9 (IP44) =0 460P9 (IP67) =Z	(DEFAULT) BLACK = 0 BLUE = B RED = R WHITE = W GREEN = G YELLOW = Y	(DEFAULT) 1.8m [6'] = 0 1m [3.2'] = 1 2m [6.6'] = 2 3m [10'] = 3	(DEFAULT) TOP FEED = 0 BOTTOM FEED = 2	
OPTIONS LISTED ON THIS ROW ARE NON STANDARD, CONTACT SALES FOR ADDITIONAL INFORMATION		ORANGE = A	0.5m [1.6'] = A 1.5m [4.9'] = B 2.5m [8.2'] = C	1.2m [4'] = G 1.8m [6'] = F	

- NOTES :
- INSTALLATION SHALL COMPLY WITH ALL APPLICABLE NATIONAL, STATE AND LOCAL CODES.
 - PRIMARY DIMENSIONS ARE IN MILLIMETERS. SECONDARY DIMENSIONS ARE IN [INCHES]
 - UNIVERSAL MOUNTING BRACKET IS AN ALTERNATIVE MOUNTING METHOD TO THE TOOLLESS MOUNT FOR 3RD PARTY ENCLOSURES. BRACKET IS PROVIDED WITH THE UNIT.
 - DETAILED INSTALLATION INSTRUCTIONS CAN BE FOUND IN THE QUICK START GUIDE
 - CONNECT EXTERNAL EARTH GROUND TO THE 10-32 SIZE THREADED NUT
 - SEE PRODUCT DOCUMENTATION FOR FURTHER INFORMATION
 - INPUT PLUG CONFIGURATION (SEE IDENTIFICATION TABLE) FOR DUAL-RATED UNITS, NEMA PLUGS ARE NAM RATED ONLY AND CAPTIVE AUS/NZ PLUGS ARE EMEA RATED ONLY

THIS DRAWING AND SPECIFICATIONS HEREIN ARE THE PROPERTY OF CIS GLOBAL AND SHALL NOT BE COPIED, REPRODUCED OR USED IN WHOLE OR IN PART, AS THE BASIS FOR THE MANUFACTURE OR SALE OF ITEMS WITHOUT WRITTEN PERMISSION FROM CIS GLOBAL. THIS DRAWING IS BASED UPON LATEST AVAILABLE INFORMATION AND IS SUBJECT TO CHANGE WITHOUT NOTICE

ECN/ECO	REV.	DESCRIPTION	DATE	APPROVED
ECN-2210-0226	E2	REVISE METER ACCURACY AND ATTRIBUTES CONTENT	2022/10/08	LRF
	E1	INITIAL DRAFT REVIEW	2022/04/14	Leo Liu

TITLE :		UNLESS NOTED, DIMENSIONS ARE IN MILLIMETERS & TOLERANCES ARE:		PART NO.:	
Advantage Series Basic		X ±1 MM	X° ±1°	RB0952WXYZ_DA	
		X.X ±0.5 MM	X.X° ±0.5°	REV. E2	
		X ±0.20 MM		DRAWN BY: Leo Liu 2022/04/14	
		Ø X.X ±0.3 MM		ENGINEER: LJB 2022/10/08	
		Ø X.XX ±0.10 MM		APPROVED BY: Hanson 2022/10/08	
PROJECT: RackPower		BRACKETED DIMENSIONS ARE IN INCHES FOR REFERENCE ONLY		SCALE : N/A	
		⊕ THRID ANGLE PROJECTION		SHEET 1 OF 3	
		INTERPRET PER ASME Y14.5M-1994		SIZE: A3	

16 15 14 13 12 11 10 9 8 7 6 5 4 3 2 1

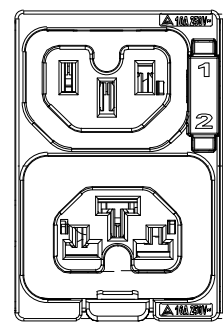
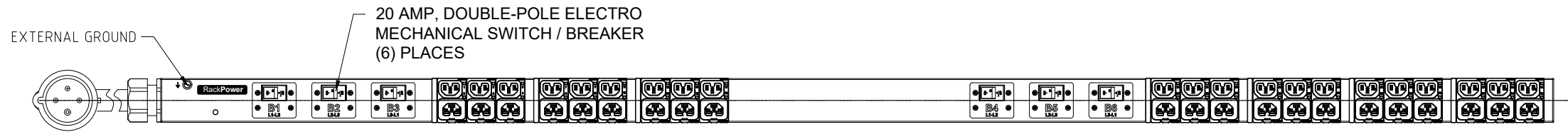

RECEPTACLE

C13/C15 COMBO
10A, 250V MAX
RATED OUTPUT

C13/C15/C19 COMBO
16A, 250V MAX
RATED OUTPUT

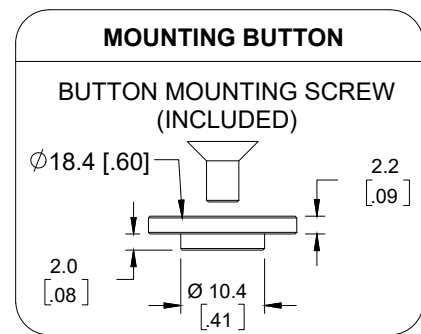
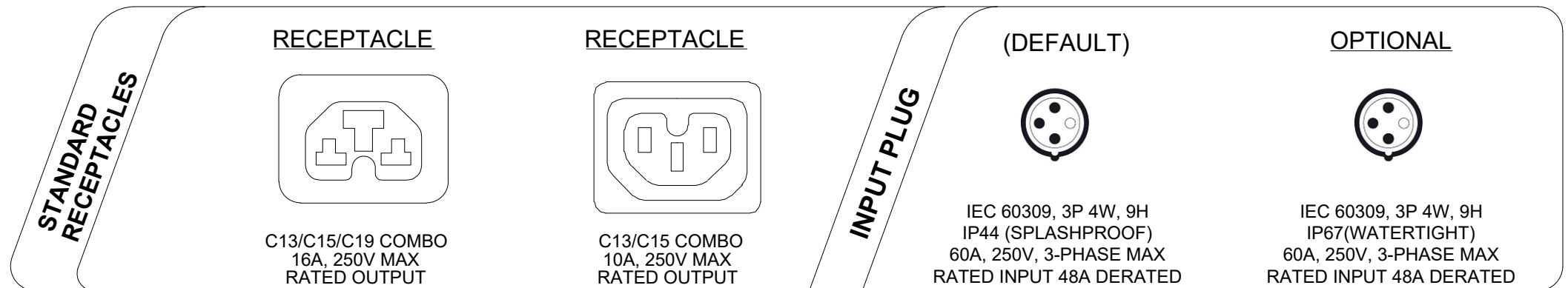

ECN/ECO	REV.	DESCRIPTION	DATE	APPROVED
ECN-2210-0226	E2	REVISE METER ACCURACY AND ATTRIBUTES CONTENT	2022/10/08	LRF
	E1	INITIAL DRAFT REVIEW	2022/04/14	Leo Liu

- NOTES :**
- INSTALLATION SHALL COMPLY WITH ALL APPLICABLE NATIONAL, STATE AND LOCAL CODES.
 - SEE PRODUCT DOCUMENTATION FOR FURTHER INFORMATION

THIS DRAWING AND SPECIFICATIONS HEREIN ARE THE PROPERTY OF CIS GLOBAL AND SHALL NOT BE COPIED, REPRODUCED OR USED IN WHOLE OR IN PART, AS THE BASIS FOR THE MANUFACTURE OR SALE OF ITEMS WITHOUT WRITTEN PERMISSION FROM CIS GLOBAL. THIS DRAWING IS BASED UPON LATEST AVAILABLE INFORMATION AND IS SUBJECT TO CHANGE WITHOUT NOTICE

TITLE :
Advantage Series
Basic

PROJECT :
RackPower

UNLESS NOTED, DIMENSIONS ARE IN MILLIMETERS & TOLERANCES ARE:
 X ±1 MM X" ±1"
 X.X ±0.5 MM X.X" ±0.5"
 X ±0.20 MM
 Ø X.X ±0.3 MM
 Ø X.XX ±0.10 MM

BRACKETED DIMENSIONS ARE IN INCHES FOR REFERENCE ONLY

⊕ THRID ANGLE PROJECTION
INTERPRET PER ASME Y14.5M-1994

PART NO.:
RB0952WXYZ_DA

REV.:
E2

DRAWN BY: Leo Liu 2022/04/14

ENGINEER: LJB 2022/10/08

APPROVED BY: Hanson 2022/10/08

SCALE : N/A

SHEET 2 OF 3

SIZE: A3

nvent | SCHROFF RackPower Distribution Unit
Basic

SKU #: RB0952WXYZ
Model #: EP404048-0061-C
INPUT: 200-240VAC, DELTA, 3PHASE, 50/60Hz, 48A
OUTPUT: C13/C15 COMBO; 200-240VAC, 10A per outlet
C13/C15/C19 COMBO; 200-240VAC, 16A max per outlet
48A Total

Made In XXXXX

SKU#: RB0952WXYZ
Serial Number: XXXXXXXX
PRODUCT CODE: XXXXX

COMPLIANCE LABEL

NOTES:

1. INTERNAL WIRING

- WIRE TYPE: UL AWM 1015,10 & 12 & 18 AWG
- LINE 1/R/X COLOR: Black
- LINE 2/S/Y COLOR: Orange
- LINE 3/T/Z COLOR: Red
- EARTH GROUND COLOR: Green/Yellow

2. FOR FINISHED GOOD PART NUMBER SEE IDENTIFICATION

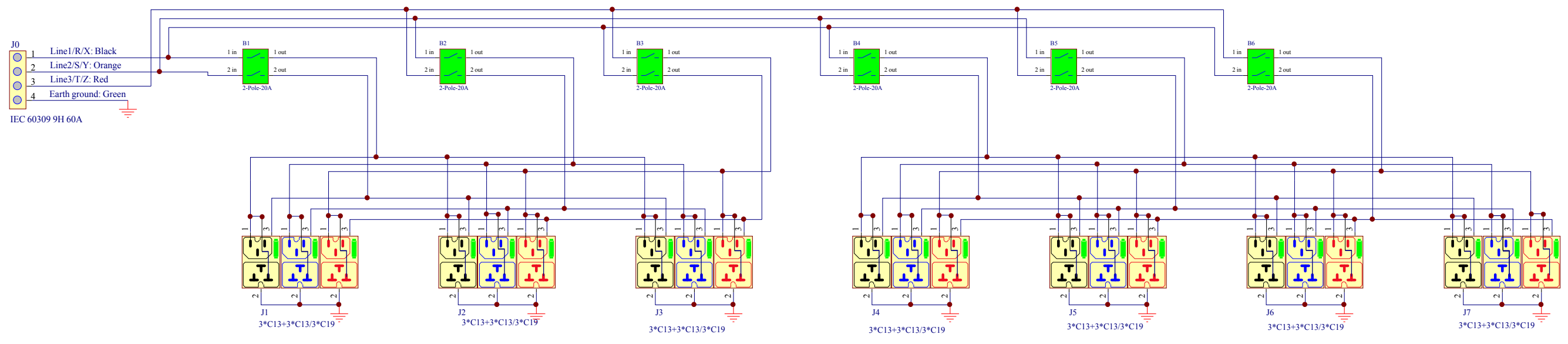

INTERNAL WIRING SCHEMATIC

- NOTES:
1. INSTALLATION SHALL COMPLY WITH ALL APPLICABLE NATIONAL, STATE AND LOCAL CODES.
 2. SEE PRODUCT DOCUMENTATION FOR FURTHER INFORMATION.
 3. THIS DRAWING DEPICTS THE POWER SYSTEM CONNECTIONS AND IS NOT REPRESENTATIVE OF THE PHYSICAL LAYOUT. PLEASE REFER TO MECHANICAL DRAWINGS FOR PHYSICAL LAYOUT.

nvent | SCHROFF

THIS DRAWING AND SPECIFICATIONS HEREIN ARE THE PROPERTY OF CIS GLOBAL AND SHALL NOT BE COPIED, REPRODUCED OR USED IN WHOLE OR IN PART, AS THE BASIS FOR THE MANUFACTURE OR SALE OF ITEMS WITHOUT WRITTEN PERMISSION FROM CIS GLOBAL. THIS DRAWING IS BASED UPON LATEST AVAILABLE INFORMATION AND IS SUBJECT TO CHANGE WITHOUT NOTICE

ECN/ECO	REV.	DESCRIPTION	DATE	APPROVED
ECN-2210-0226	E2	REVISE METER ACCURACY AND ATTRIBUTES CONTENT	2022/10/08	LRF
	E1	INITIAL DRAFT REVIEW	2022/04/14	Leo Liu

REVISIONS

TITLE : Advantage Series Basic

PROJECT : RackPower

UNLESS NOTED, DIMENSIONS ARE IN MILLIMETERS & TOLERANCES ARE:

X	±1 MM	X°	±1°
X.X	±0.5 MM	X.X°	±0.5°
X	±0.20 MM		
∅ X.X	±0.3 MM		
∅ X.XX	±0.10 MM		

BRACKETED DIMENSIONS ARE IN INCHES FOR REFERENCE ONLY

⊕ THRID ANGLE PROJECTION

INTERPRET PER ASME Y14.5M-1994

PART NO: RB0952WXYZ_DA

REV: E2

DRAWN BY: Leo Liu 2022/04/14

ENGINEER: LJB 2022/10/08

APPROVED BY: Hanson 2022/10/08

SCALE : N/A

SHEET 3 OF 3

SIZE: A3