



CONNECT AND PROTECT

OFFSHORE APPLICATIONS

nvent

RAYCHEM



A SOLUTIONS COMPANY

nVent provides complete heat-tracing and heat management solutions to the industrial, commercial and residential markets. Employing thousands of people around the world, nVent is the global heating solutions leader.

WORLDWIDE APPROACH

With decades of heat tracing experience, operations in more than 48 countries and a global presence, nVent can support your project efforts anywhere, anytime.

PRODUCTS AND SERVICES

Whether from the Norwegian Sea to the Barents Sea, or from the North Atlantic Ocean to the Bohai Sea in China, nVent offers process temperature maintenance, pipe freeze protection, de-icing and fire-rated wiring applications for offshore drilling platforms everywhere. nVent has products and services dedicated to offshore oil and gas industry for over 30 years.

CUSTOMIZED SOLUTIONS

nVent provides a variety of offshore heat-tracing and fire & performance wiring solutions to ensure oil & gas quality and the safety of platform shipping. Our top-notch products, state-of-the-art design tools and proven project management experience ensure proper selection of technology, execution strategy and adherence to applicable standards.

Offshore Operation Focus

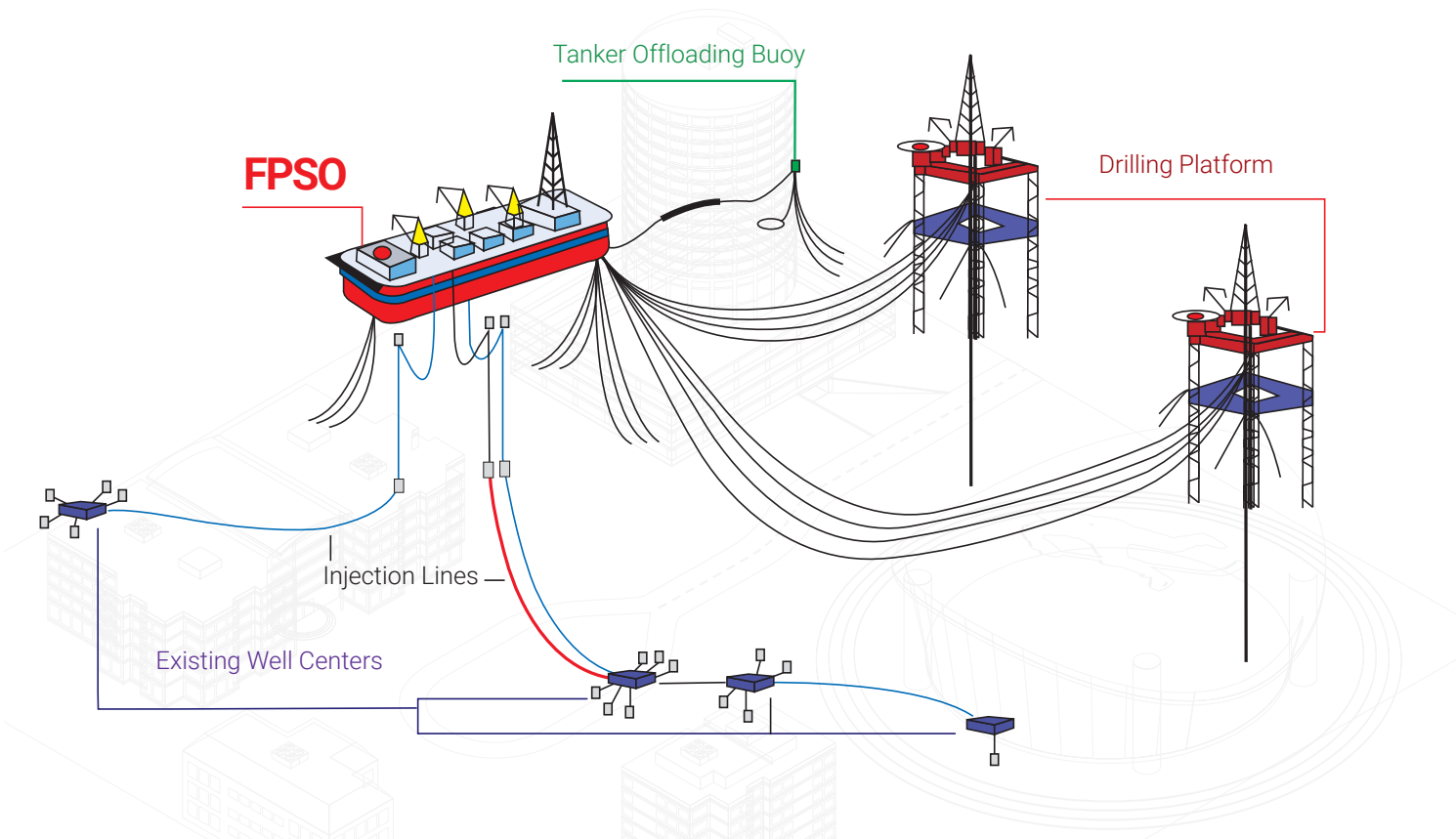

Drilling/production facilities (drilling rig or oil platform) and **Processing/Storing/Transporting facilities** (FPSO, storage tank and subsea pipeline) require heat tracing to keep processes running efficiently. Heat tracing can also be used to lower oil viscosity and solve wax and/or paraffin problems associated with offshore oil wells.



Floating Production, Storage and Offloading Vessel (FPSO)



Fixed Platform

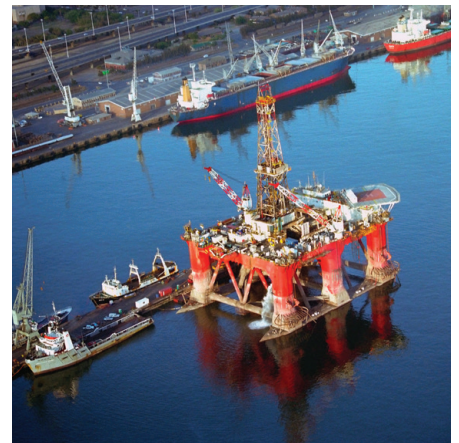

Semi-submersible Rig

Heat-Tracing Applications On Offshore Platform

We Offer Extensive Application Solutions in The Offshore Oil & Gas Industry With Respect to Purpose-Specific Areas, Modules and Facilities.



COMMUNICATION

- De-icing



PRODUCTION TREE AREA

- Process Temperature Maintenance
- Fire & Performance Wiring
- Leak Detection
- Instrument Winterization

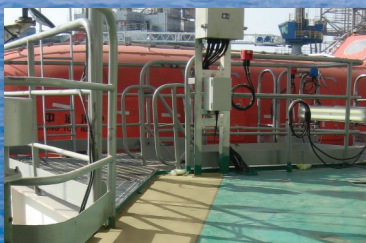

ESCAPE PASSAGES

- Anti-icing

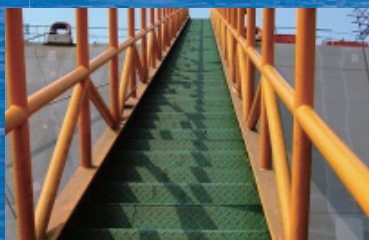

STAIRCASES/HANDRAILS

- De-icing



LIFE BOAT LOADING AREA

- Anti-icing



PROCESSING AREA

- Process Temperature Maintenance
- Instrument Winterization

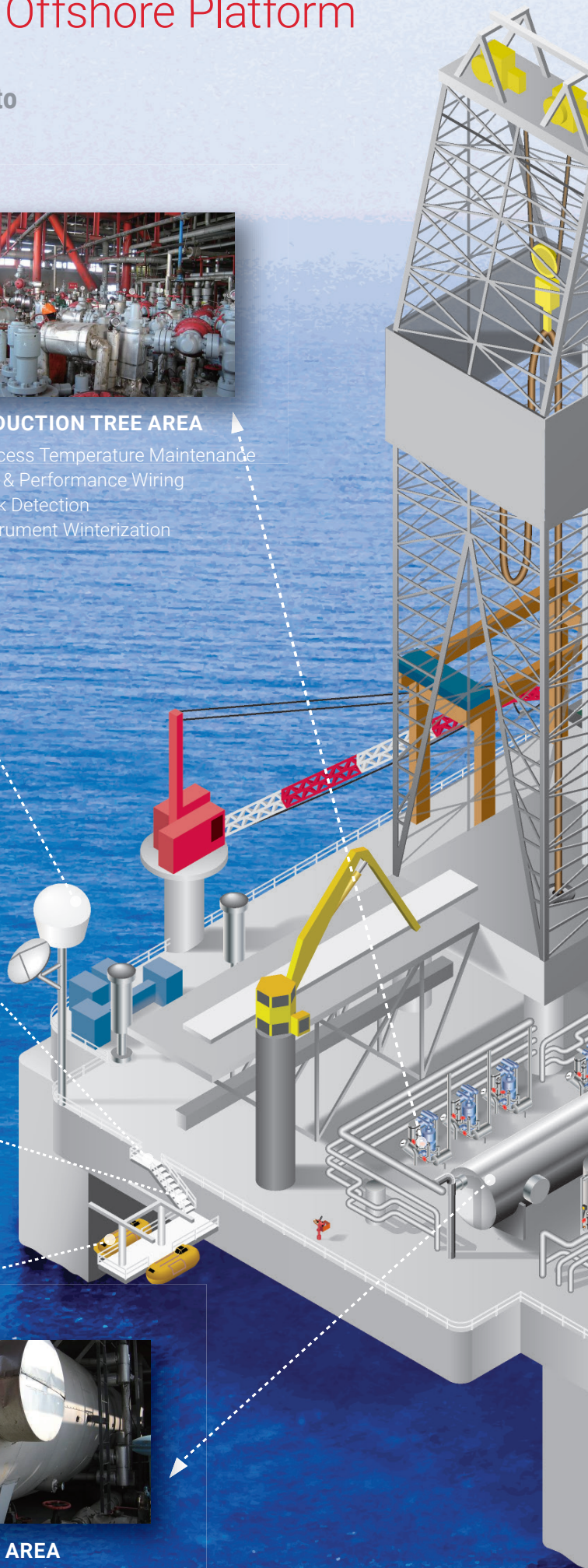

- SAFETY
- PROCESS
- WINTERIZATION
- COMFORT

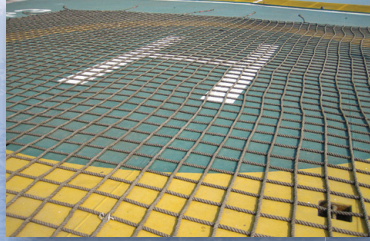

HELIDECK
■ Anti-icing



LIVING QUARTERS
■ Hot Water Temperature Maintenance
■ Floor Heating



HATCHES/DOORS
■ Anti-icing



FIRE HYDRANT
■ Freeze Protection
■ Fire & Performance Wiring



DRILLING & WATER INJECTION AREA
■ Pipe Freeze Protection
■ Instrument Winterization
■ Leak Detection

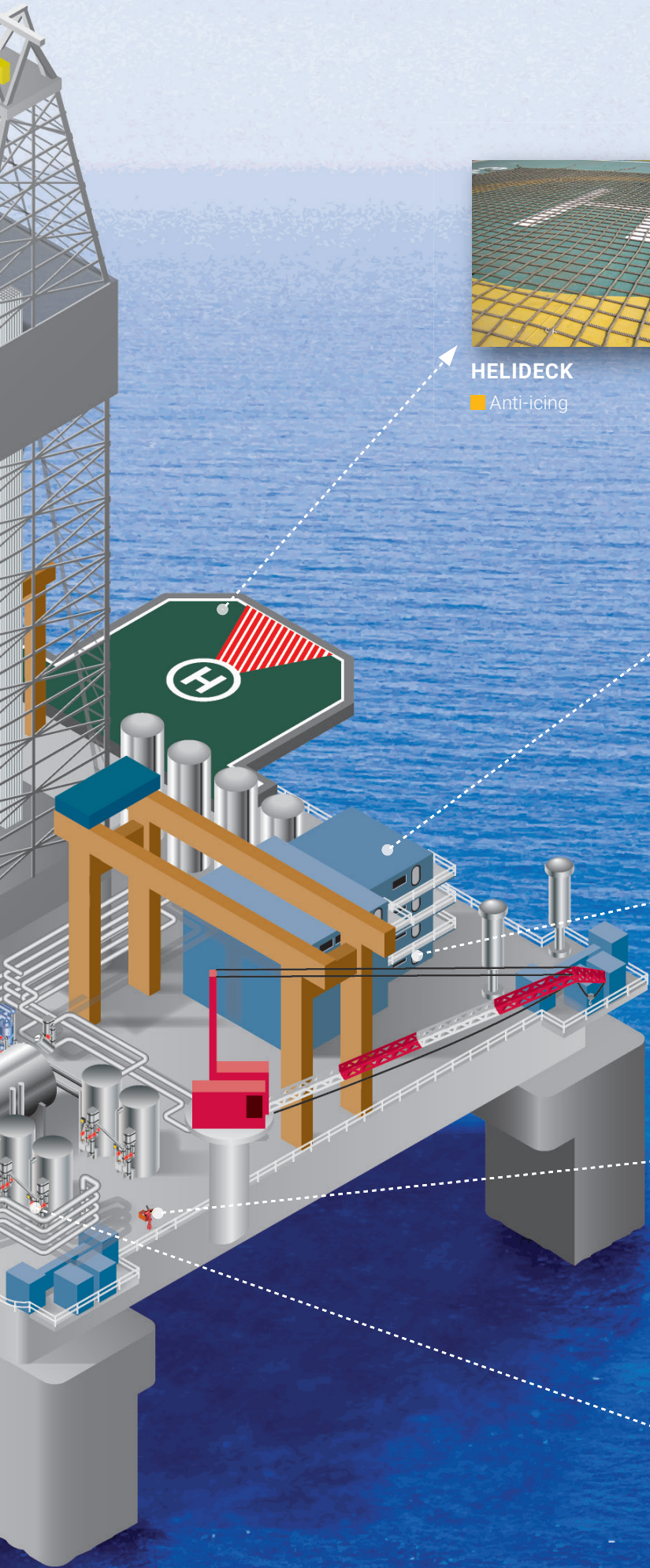

Offshore Oil/Gas Industry Application Mapping

| Scope | | Solutions on ... | Our Offering |
|---------------|---------------------------------|--|--|
| Winterization | Anti-Icing | Escape Passage, Walkway, Staircase, Handrail, Doors And Escape Hatches, | Heat Tracing (Self-Regulating, MI); Control & Monitoring (NGC Family, Thermostat) |
| | De-Icing | Lay Down Area, Helideck, Louver, Life Boat Davit, GPS Antenna | |
| | Instrument Winterization | Canvas Cover For Outdoor Instrument, Transducer, Instrument Tube | |
| | Water Pipe Freeze Protection | Production Water, Fresh Water, Sea Water, Waste Water, Fire Hydrant | |
| Process | Process Temperature Maintenance | Process Pipe, Oil Pipe, Instrument Analyzer | Heat Tracing (Self-Regulating, MI); Control & Monitoring (NGC Family, Thermostat); Tubing Bundle |
| | Long Transfer Line | Subsea Pipeline | STS Tracing System |
| Comfort | Living Comfort | Change Room, Bed Room, Bath Room, Dining Room | Floor Heating, Hot Water Temperature Maintenance (HWAT) |
| | Operation Comfort | Control Room, Steering Room | |
| Safety | Leak Detection | Oil & Water Leak Detection | TraceTek Leak Detection, Industrial Wiring (Alloy 825) |
| | Fire Protection | Flare Stack Wiring, Emergency Lighting, Fire Alarm Circuits, MOV and EBV Wiring | |

Winterization

ANTI-ICING/DE-ICING

Concerns

Icing is a major concern for year round operation in cold climate regions. Platform ice accretion is caused by atmospheric icing and sea-water spray icing.

- Ice attached to the piling structure will increase wave impact on platform.
- Ice attached to the bottom deck will cause unbalanced weight loading of platform. The platform might be tilted due to mechanical resonance.
- Icing on platform surfaces can lead to slip and fall accidents.
- Icing on the helideck may endanger the safety of helicopter.
- Icing on the antenna will impact GPS positioning and telecommunication.

Solutions

Icing can be prevented or eliminated by installing anti-icing and de-icing systems. With safety and reliability features, self-regulating electrical heat-tracing systems are ideal for icing prevention applications. Based on the accurate surface heat loss model, we implement electrical heat tracing throughout the whole platform. The design maintenance temperature of 0°C to +2°C is usually specified even though sea water freezes between -2.8°C to 0°C.

The comprehensive consideration for optimizing heat loss is very important. Take the technical specifications for arctic helideck anti-icing system for example, the total heat loss from the upside and downside of helideck was decreased to 788 watts by virtue of wind barrier and thermal insulation. The electrical heat tracing was attached under the top layer of the aluminum helideck.

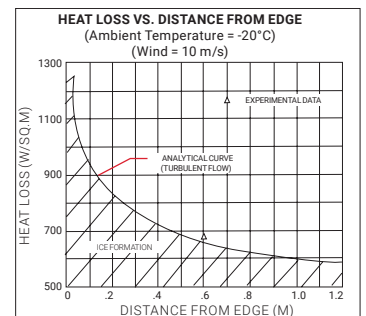
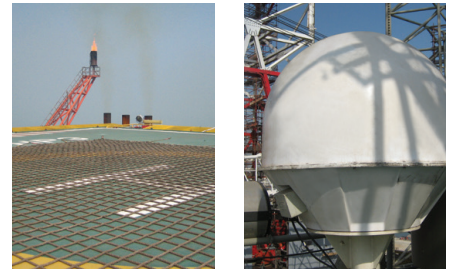

RAYCHEM uses accurate surface heat loss model to ensure accurate heat tracing.

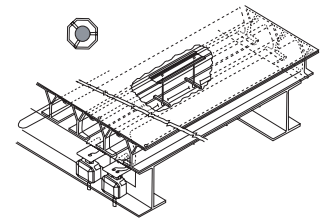

INSTRUMENT WINTERIZATION

Concerns

There are various instrument lines on an offshore process like level, pressure and flow. Due to the small diameter of the instrument tube, fluids can easily freeze in winter. Traditional steam or electrical heat tracing with its various accessories would be complicated and difficult to install due to limited space and small size of the pipe. silicone

Solutions

We can provide pre-traced and pre-insulated tubing bundle systems, for both non-traced and electrical or steam heat-tracing applications. The heating cable, pre-insulated tubes, plus components and controllers deliver a comprehensive and reliable system designed for process temperature maintenance, freeze protection, temperature exposure, and hazardous areas requirements in every application.

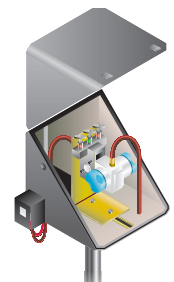

A pre-fabricated tubing bundle and enclosure can facilitate instrument winterization and reduce failure rate.

WATER PIPE FREEZE PROTECTION

Concerns

Water systems in offshore facilities (including potable water, fire water, drill water, injection water, ballast water, bilge water, etc) are vulnerable to freezing in winter. This can cause delays in critical processes. The freeze in winter will cause the pipes to choke and normal process can't be guaranteed.

Solutions

Self-regulating heating cables can be used for freeze protection. By heating to 2°C or above, we can prevent water pipes from freezing. Different types of heating cable are specified based on pipe diameter.



Pipe freeze protection for fire suppression

Process

PROCESS TEMPERATURE MAINTENANCE

Concerns

Offshore oil reservoirs usually contain large volumes of water and smaller volumes of gas. While the mixed fluid (production fluid) is lifted to the platform, the oil, water and gas is required to be separated and transferred in different pipeline. The flow rate of medium could decrease if the temperature is not maintained at certain temperature.

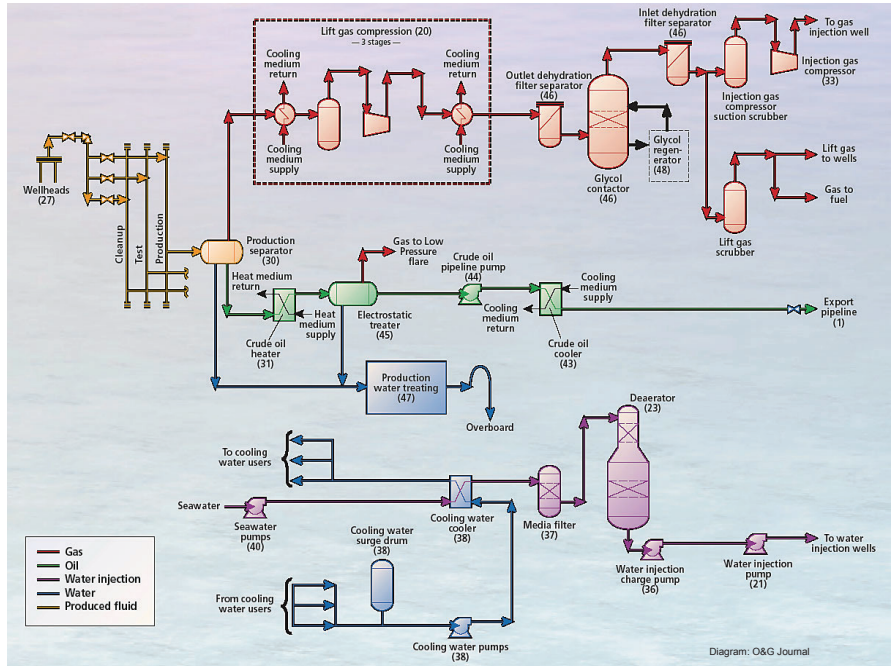

Typical production flow chart (without drilling)

Solutions

To ensure the accurate temperature maintenance for the different oil (crude oil: 40°C, lubricant: 20°C), we offer not only self-regulating heating cables, but also advanced control monitoring systems which will assure the accurate pipe temperature can be maintained.

The control panel operates as power distribution, temperature control and circuit monitoring. The heat tracing circuit data is transferred to the Client/Server software in the supervisory level PC.

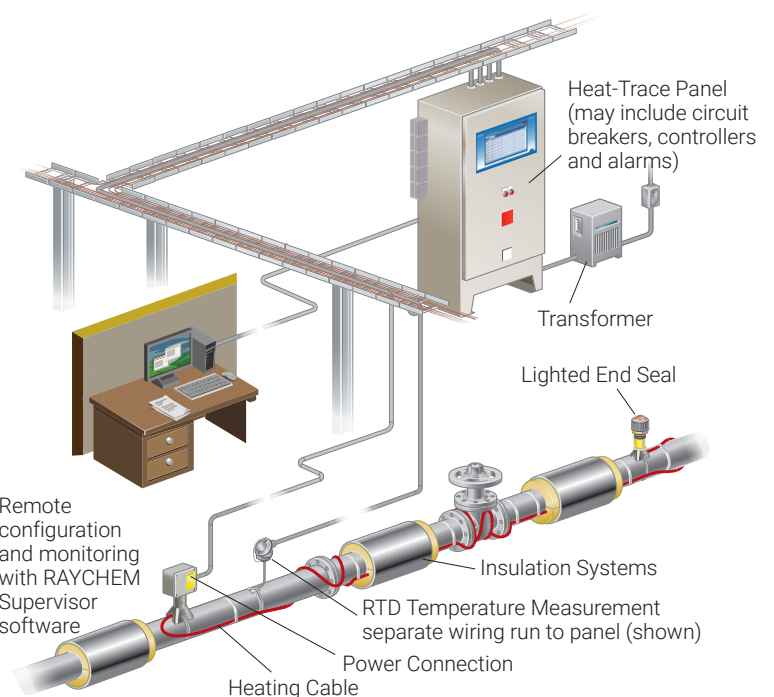
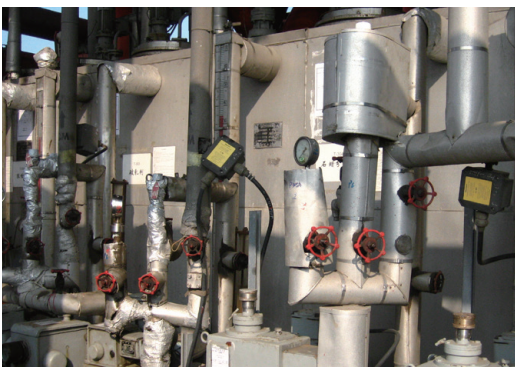

Safety

LEAK DETECTION

Concerns

Leaky oil or natural gas pipes on an offshore platform can contribute to the safety problems or pollution of our oceans. This can lead to penalties for environmental damage and may cause flash fires when occurring in hazardous areas. Natural gas flow lines on production platforms often leak gas condensates along with the gas from the flanges, joint fittings, etc. Undetected gas leaks can be dangerous but TraceTek can detect and locate the associated condensate leak.

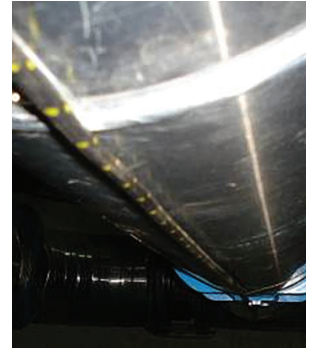

Solutions

TraceTek Leak Detection Systems will detect and locate the leak and send an alarm signal to the central control and monitoring system. This can help prevent small leaks from turning into catastrophic events which can shut down production, cause environmental damage and loss of production, etc.

FIRE PROTECTION FOR CRITICAL CIRCUITS

Concerns

In case of hydrocarbon fire, circuit integrity needs to be maintained to provide power to EBV (short for "Emergency Block Valve") and MOV (short for "Motor Operated Valve") for emergency shutdown. Critical life safety circuits are needed to provide an uninterrupted power supply to emergency escape lighting and smoke extraction systems to ensure proper function during fire. The polymer fire retardant cable will fail immediately in the hydrocarbon rapid rise flash fire which can cause the temperature to rise as high as 1100°C in 5 minutes.



Enclosed furnace test for cable splice



Alloy 825 MI wiring cable with KMASS gland protector can survive in the flash fire

Solutions

Fire-rated cables can help guarantee circuit integrity for all critical equipment circuits including: motor operated valves, fire pumps, fire alarms, emergency lighting and emergency power in case of hydrocarbon flash fire. Pyrotex Alloy 825 sheath MI wiring cable can survive to ensure emergency shutdown of production unit.

The complete Fire Performance Wiring System is comprised of the products below. The system passes the 30 minutes flash fire test as per the UL1709 and UL2196 Standard.

- Mineral insulated (MI) wiring cable
- Fire proof splice
- Fire proof junction box
- Gland protector

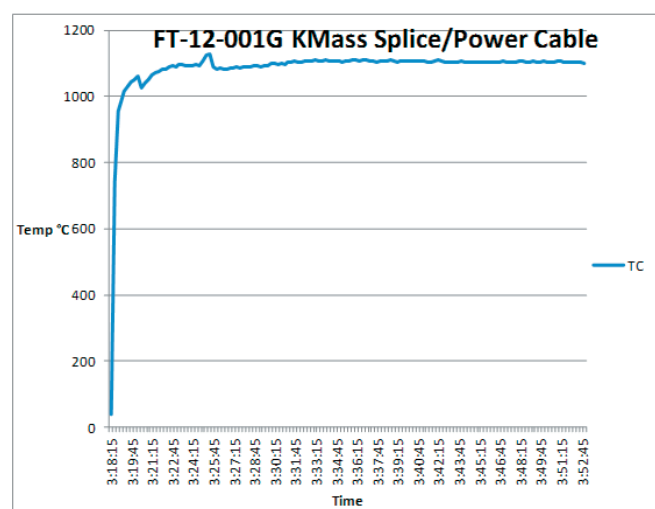

Rapid rise fire Time/Temp profile (5 minutes up to 1093°C) meeting UL1709 Standard

Distinctive Advantages

THE WIDE RANGE OF PRODUCTS AND SOLUTIONS OFFERED BY NVENT CAN SATISFY MANY DIFFERENT REQUIREMENTS ON APPLICATIONS IN THE OFFSHORE OIL AND GAS INDUSTRY.

EXPLOSION PROOF

Offshore oil and gas production is often completed in hazardous areas which require Ex-Proof rated equipment and apparatus. nVent, as a worldwide heat-tracing solution provider, has acquired authoritative approvals required for different geographic locations.



HARSH ENVIRONMENT PROOF

Due to the extreme climatic conditions on an offshore platform, most operational failure is caused by corrosion of equipment. RAYCHEM brand heating cable with a fluoropolymer outer sheath has excellent organic and inorganic chemical resistance. This helps prevent equipment corrosion caused by exposure to salt water. Industrial wiring using Alloy 825 sheath has premium chemical resistance as well as flash fire survival performance.

ENERGY EFFICIENCY

Offshore platforms are similar to self-supporting energy systems in that energy efficiency is quite critical. Based on an accurate surface heat loss model, RAYCHEM self-regulating heating systems avoid excess by supplying the proper amount of heat to pipes and vessels. No excess heat is output.

EASY INSTALLATION

The quick connection kit and cold-applied components enable easy installation on site. Self-regulating heating cable can be overlapped many times with a small bending radius. This will dramatically decrease the installation time especially in supports, flanges and valves.



Prefabricated components for helideck enables quick installation on offshore platform.

ADVANCED CONTROL AND MONITORING

Through integrated control & monitoring systems, all heating circuits can be fully monitored and controlled from one central location. Potential failure can be predicted ahead of time which will reduce downtime and enhance productivity.



Integrated Control & Monitoring: the NGC Family

MARITIME CERTIFICATION

In marine industry, it is mandatory for all facilities to pass maritime certification before getting installed on the platform. nVent's products can fulfill the requirements of marine industry standards and successfully pass or meet the required marine certifications.



SERVICE CAPABILITIES

With nVent, customers will realize a high level of design excellence, ingenuity, quality, integrity and product expertise throughout the project, from concept to commissioning. Our network of service centers provides customers with regional experts. These experts are familiar with specific codes and requirements allowing them to complete your project in a safe and timely manner.



CASE STUDY

- End Users:** China CNOOC Oil Corporation Tianjin Branch
- Applications:** Pipe Freeze Protection
Process Temperature Maintenance
- System:** RAYCHEM Self-regulating Heat-tracing System 178 electrical heat-tracing circuits, 9000 meters BTW, QTVR heating cables
- Year of Installation:** 1999

PROJECT PROFILE

As an offshore oil and gas production platform operating in all weather conditions, QK17-2 is a major part of the entire Boxi offshore oilfield. The oil and gas produced receives a pre-treatment, is delivered to a QK17-2 platform, and is finally transported to land. The temperature around QK17-2 oilfield is from 33.4°C to -13°C.

APPLICATION REQUIREMENTS

Offshore oil platforms require that production remains continuous under harsh environmental forces. The oil viscosity in production processes needs to be very well controlled to ensure smooth transfer. Due to the low temperature in winter, the liquid in pipes of platform equipment tends to freeze if exposed to the freezing point for a long time.

APPLICATIONS

Pipe Freeze Protection:

- Seawater pipe system
- Fresh water pipe system (source water, injection water, living water, fire water)
- Closed drainage system
- Boiler feed pipes
- Dosage and biociding water treatment
- Compressed air anti-condensation
- Well workover mud piping
- Pressure instrument, flow transmitter equipment, etc.

Process Temperature Maintenance:

- Oil production tube
- Oil separating and dehydration process
- Heat exchange and measurement
- Export pump and pipe

USAGE STATUS

RAYCHEM self-regulating heat-tracing products can provide the proper amount of heat needed to maintain process requirements. The excellent corrosion resistance of the fluoropolymer jacket secures high performance, stability and a long life cycle helping QK17-2 to continuously and effectively produce oil and gas.

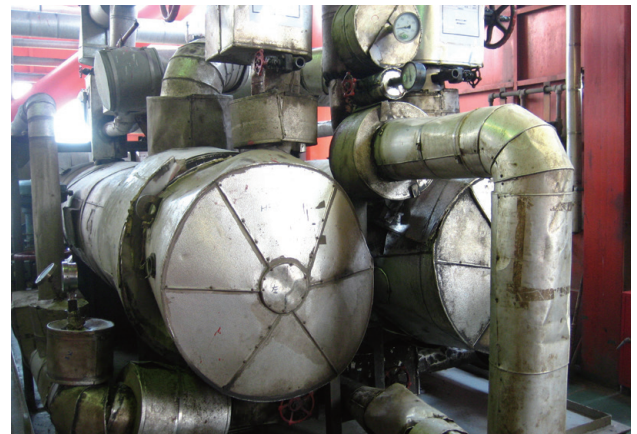

PROJECT REFERENCE LIST

- COSCO GM4000 Semisub Drilling Platform
- SAMSUNG Heavy Industries STENA Drillship
- Asandra CES Sdn Bhd FPSO Ruby Project
- ROC Oil Zhaodong Offshore Platform
- CPOE NO.9 Jackup
- Goliat SEVAN1000 FPSO
- Shell Maui FPSO
- Osaka Gas LNG Carrier

North America

Tel +1.800.545.6258

Fax +1.800.527.5703

thermal.info@nvent.com

Europe, Middle East, Africa

Tel +32.16.213.511

Fax +32.16.213.603

thermal.info@nvent.com

Asia Pacific

Tel +86.21.5426.2937

Fax +86.21.2412.1688

cn.thermal.info@nvent.com

Latin America

Tel +1.713.868.4800

Fax +1.713.868.2333

thermal.info@nvent.com

Our powerful portfolio of brands:

CADDY ERICO HOFFMAN RAYCHEM SCHROFF TRACER



nVent.com