

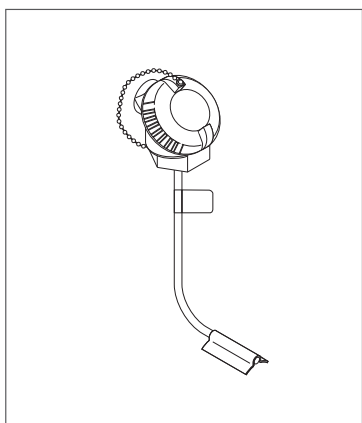

## RAYCHEM

# RTD7AL-SS

## RTD temperature sensor for temperature measurement up to 900°F (482°C) in division 1 locations Installation Instructions



### DESCRIPTION

The nVent RAYCHEM RTD7AL-SS temperature sensor is a three-wire platinum RTD (resistance temperature detector) typically used with monitoring and control systems when accurate temperature control is required. The sensor is explosion proof and approved for Division 1 and 2 hazardous locations. The RTD7AL-SS can be used with a wide variety of RAYCHEM monitoring and control systems.

These installation instructions detail the installation of the RTD7AL-SS in conjunction with existing RAYCHEM component kits.

### TOOLS REQUIRED

- 3.5 mm flat-blade screwdriver

### ADDITIONAL MATERIALS REQUIRED

- Pipe straps
- Conduit with 16–22 AWG shielded instrument cable or equivalent armored cable

### APPROVALS

The RTD7AL-SS is CSA Certified for use in North America by the manufacturer for use in Division 1 and Division 2 hazardous locations as follows:



Class I, Division 1, Groups A, B, C, D  
Class II, Division 1, Groups E, F, G  
Class I, Division 2, Groups A, B, C, D  
Class II, Division 2, Groups E, F, G

### KIT CONTENTS

Qty	Description
-----	-------------

1	RTD Temperature Sensor
---	------------------------

### SPECIFICATIONS

Sensor housing	316 stainless steel
Sensor sheath	316 stainless steel
Range	–100 to 900°F (–73 to 482°C) max
Accuracy	±1°F (0.5°C) at 32°F (0°C)
Resistance	100 ohms at 0°C $\alpha = 0.00385$ ohms/ohm/°C
Connection	3/4 in. NPT conduit hub
Operating Ambient	–40°F to 212°F (–40°C to 100°C) for all gas groups except Group A. –4°F to 212°F (–20°C to 100°C) for gas Group A

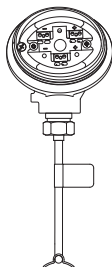
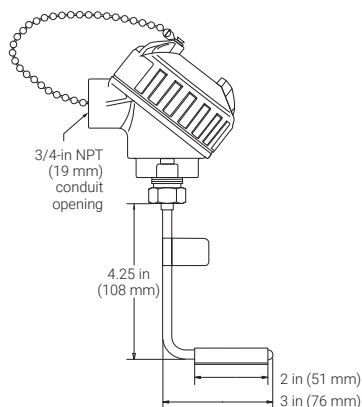

### WARNING:

This component is an electrical device. It must be installed correctly to ensure proper operation and to prevent shock or fire. Read these important warnings and carefully follow all the

installation instructions. Component approvals and performance are based on the use of specified parts only. Do not use substitute parts or vinyl electrical tape to make connections.

## WIRING INFORMATION

The length of RTD extension wires is determined by the wire gauge used.

To reduce the likelihood that electrical noise will affect temperature measurement, keep RTD extension wires as short as possible.

Use shielded instrument cable such as RAYCHEM MONI-RTD-WIRE (22AWG, PVC insulation, -30°F to 140°F, -20°C to 60°C) or Belden 83553 (22 AWG, FEP insulation, -95°F to 395°F, -70°C to 200°C).

Maximum RTD extension wire length		
AWG	Feet	(meters)
16	4500	(1400)
18	2800	(880)
20	1800	(550)
22	1100	(340)

## RTD DIRECT CONNECTION

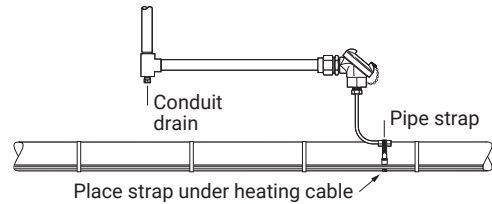

## C1D1 INSTALLATION WITH HEATING CABLE

### Electrical Wiring Notes:

Most electrical codes (such as NEC 725-15) permit Class 1 circuits to occupy the same cable, enclosure, or raceway without regard to whether the individual circuits are alternating current or direct current, providing all conductors are insulated for the maximum voltage of any conductors in the cable, enclosure or raceway.

### Additional Materials Required

- Approved junction box (supplied by others)
- HAK-C-100
- Pipe straps

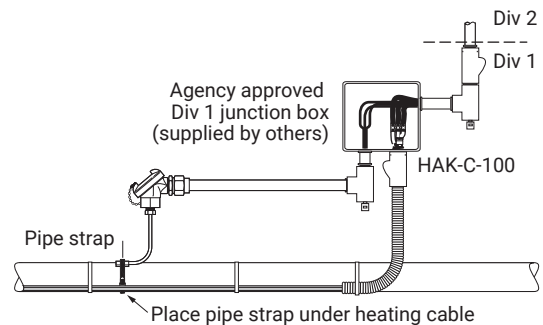

## RTD7AL WIRING

Connect the wires as shown.

**1 Note:** Ground RTD extension wire shield at one end only, preferably at RAYCHEM electronics end.

**2 Note:** RTD housing must be properly grounded using the screw provided.

### Electrical schematic of RTD

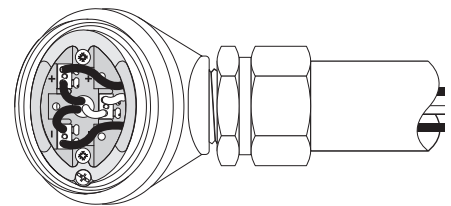
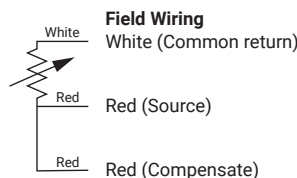

### North America

Tel. +1.800.545.6258  
 Fax +1.800.527.5703  
 thermal.info@nvent.com

### Europe, Middle East, Africa

Tel. +32.16.213.511  
 Fax +32.16.213.604  
 thermal.info@nvent.com

### Asia Pacific

Tel. +86.21.2412.1688  
 Fax +86.21.5426.3167  
 cn.thermal.info@nvent.com

### Latin America

Tel. +1.713.868.4800  
 Fax +1.713.868.2333  
 thermal.info@nvent.com



nVent.com/RAYCHEM