

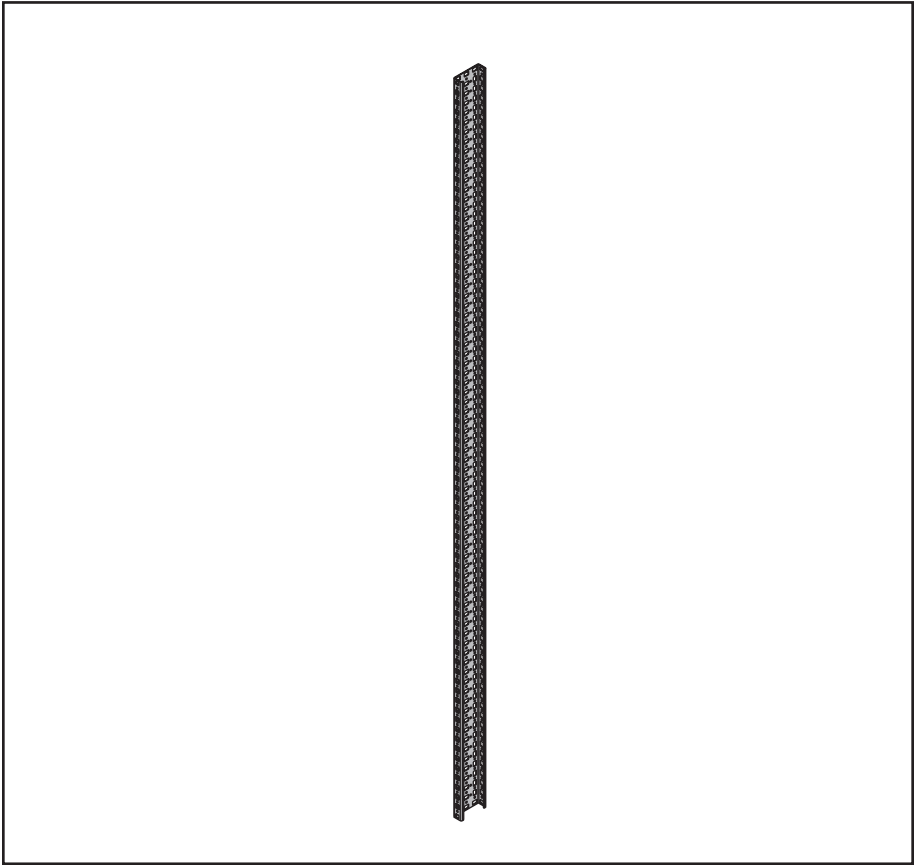

**HOFFMAN**

## PROLINE G2

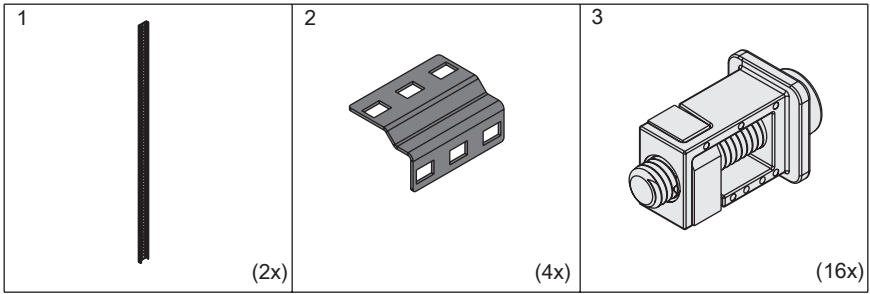



$4.5 \pm 0.5 \text{ N} \cdot \text{M}$   
 $[40 \pm 4.0 \text{ LBF} \cdot \text{IN}]$

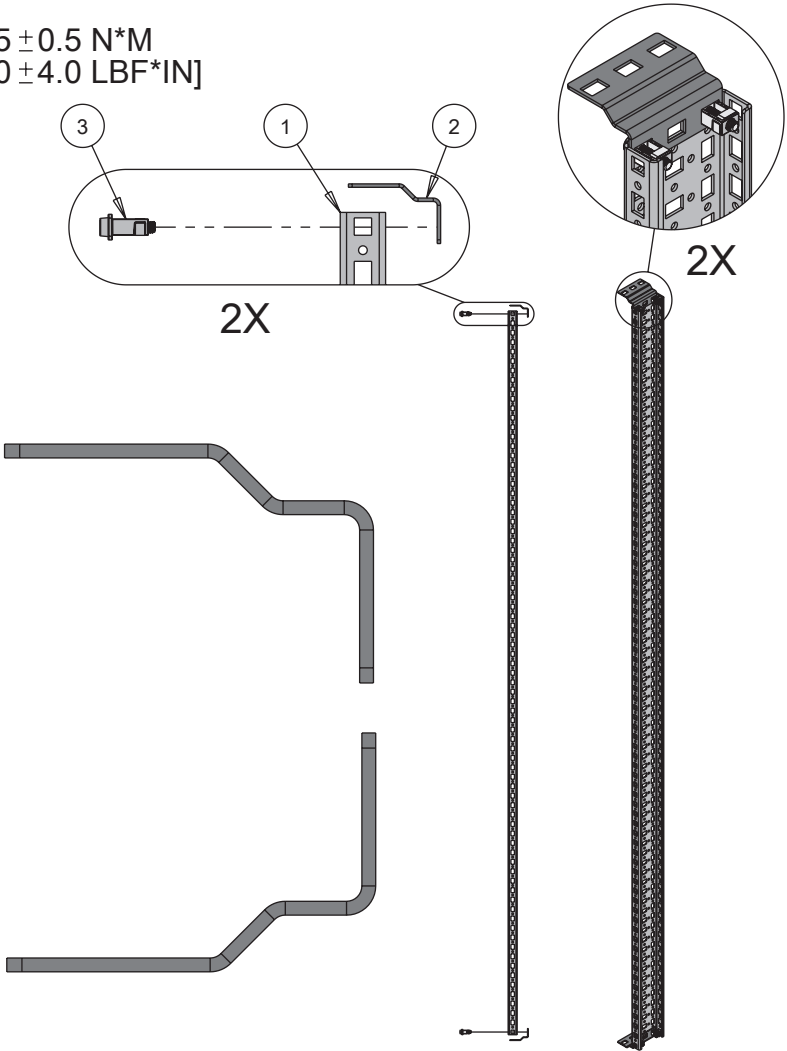

1

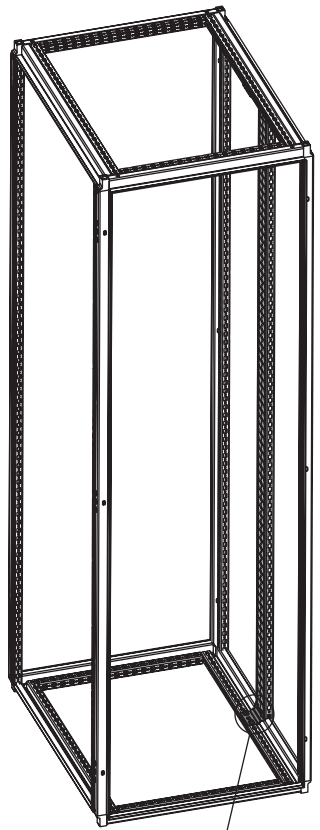
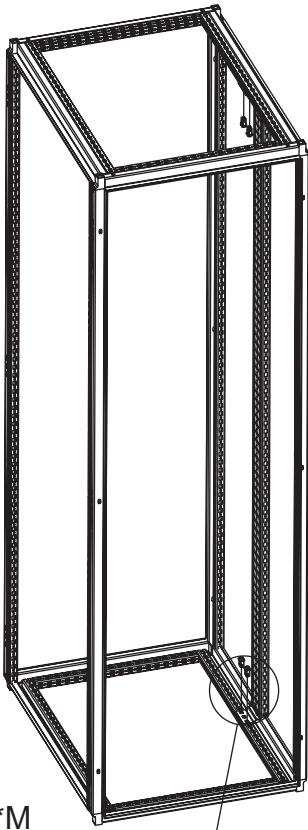

$4.5 \pm 0.5 \text{ N}^*\text{M}$   
 $[40 \pm 4.0 \text{ LBF}^*\text{IN}]$

3

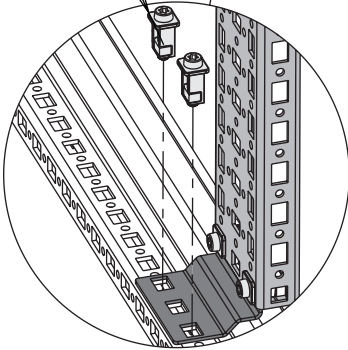

2X

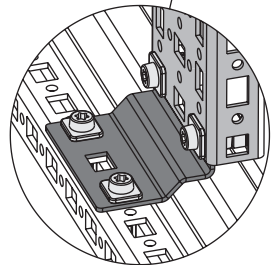

2X

2

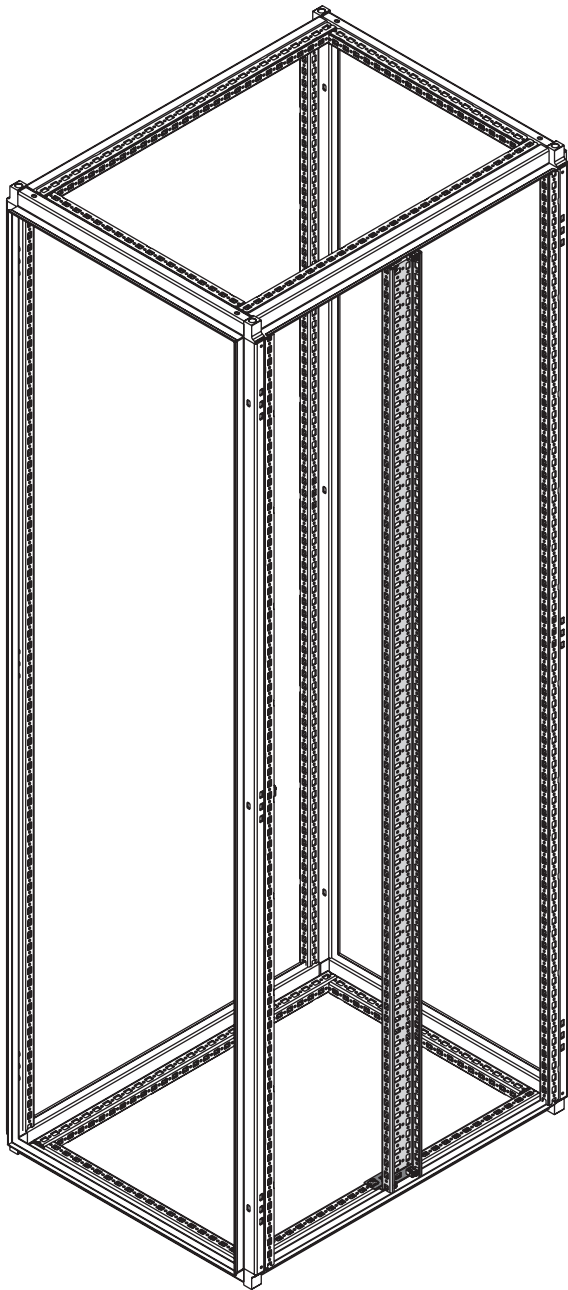

3