

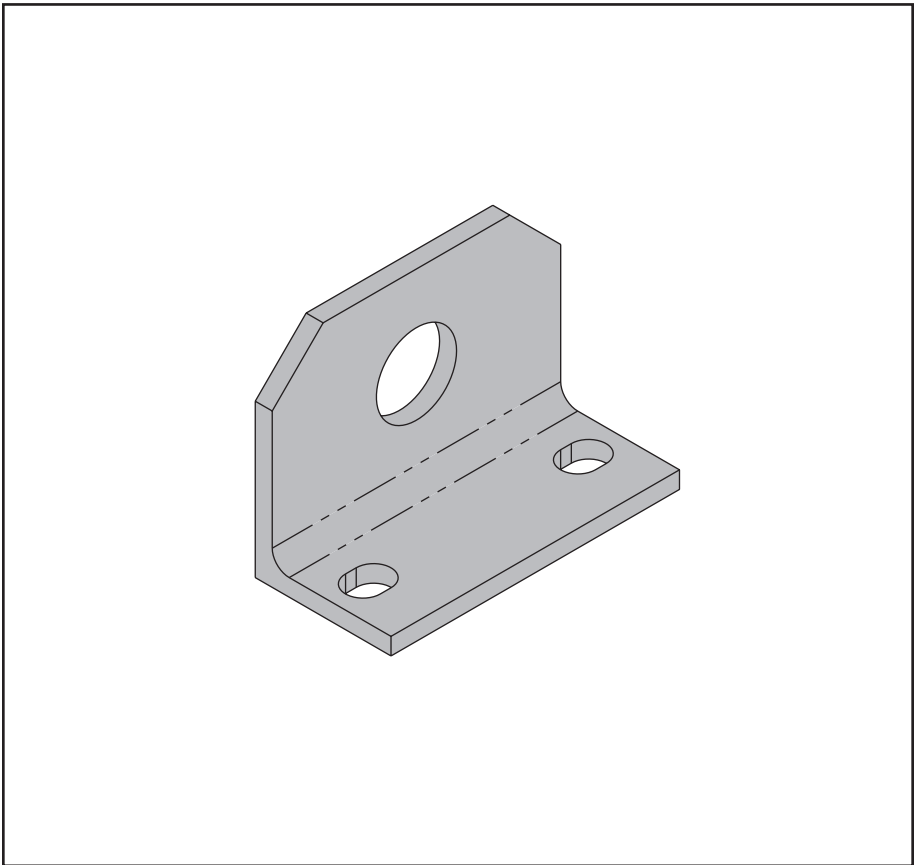

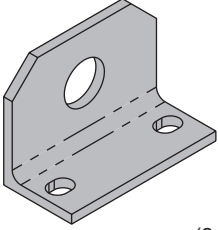



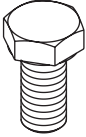

HOFFMAN

PROLINE G2

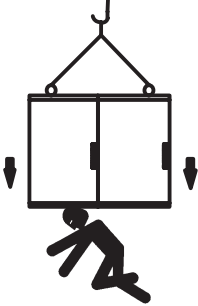

<p>1</p>  <p>(2x)</p>	<p>2</p> <p>M12</p>  <p>(4x)</p>	<p>3</p> <p>M12 X 25</p>  <p>(4x)</p>
---	---	--

 WARNING	
	<p>Loose fasteners can cause cabinet(s) to fall and cause serious injury or death and product damage.</p> <p>Torque fasteners to 30 FT-LBS.</p> <p>Use screws and washers in kits to attach lifting angles at each required lifting position of the cabinet(s) top to help avoid serious bodily injury or death due to loose fasteners.</p>

 CAUTION
<p>Insecurely joined cabinets can come apart during lifting and can fall, causing bodily injury and product damage.</p> <p>Ensure joining kit P2AJF or P2AJFHF is properly installed between each enclosure to avoid product damage and bodily injury.</p>

