

**Benutzeranleitung
Verriegelung Abdeckblech**

**User Manual
Cover plate latch**

**Instructions utilisateur
Verrouillage du capot**

Beschleunigung $\leq 10g$ (IEC 61587-1 DL2)
Acceleration $\leq 10g$ (IEC 61587-1 DL2)
Accélération $\leq 10g$ (IEC 61587-1 DL2)

Beschleunigung $> 25g$ (MIL S 901 D)
Acceleration $> 25g$ (MIL S 901 D)
Accélération $> 25g$ (MIL S 901 D)

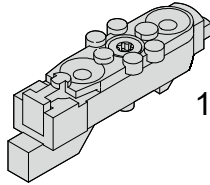

1 (4x)



2 (8x)
M 2,5 x 6
Torx T8

(1g = 9,81m/s²)

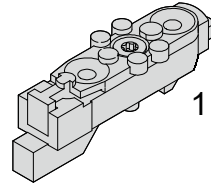

1 (12x)



2 (24x)
M 2,5 x 6
Torx T8

(1g = 9,81m/s²)

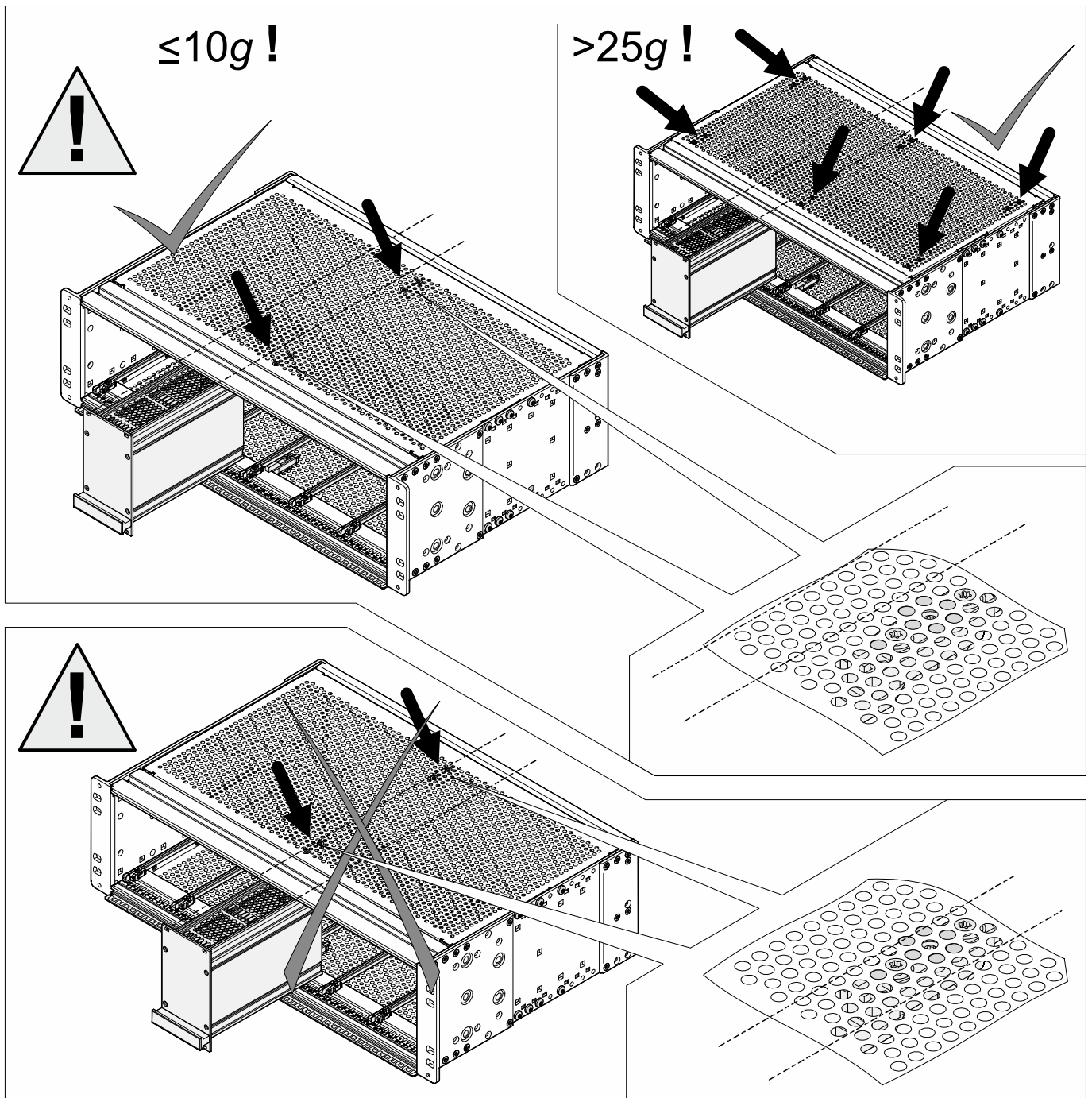

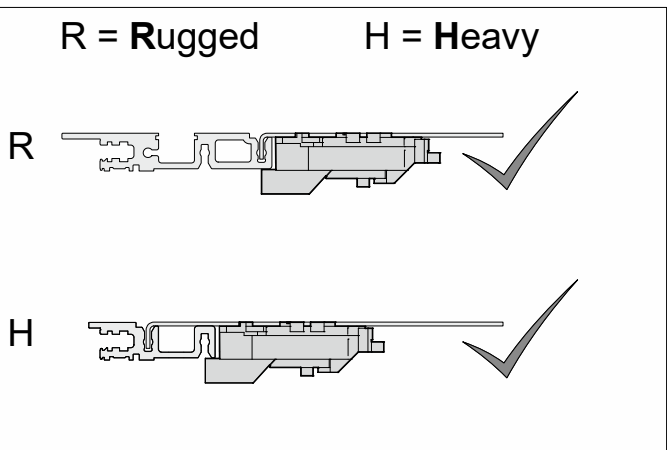
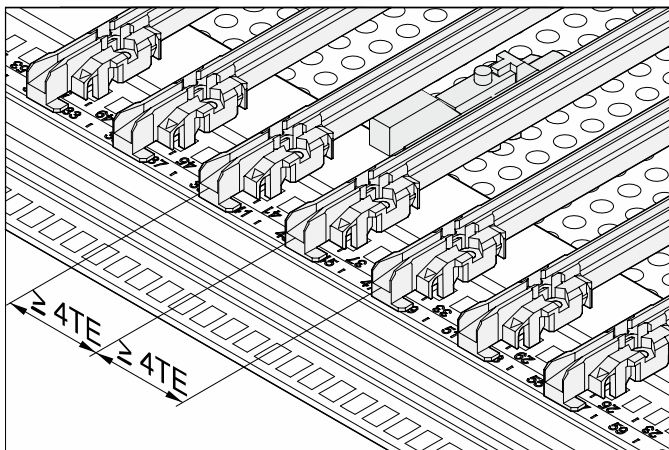
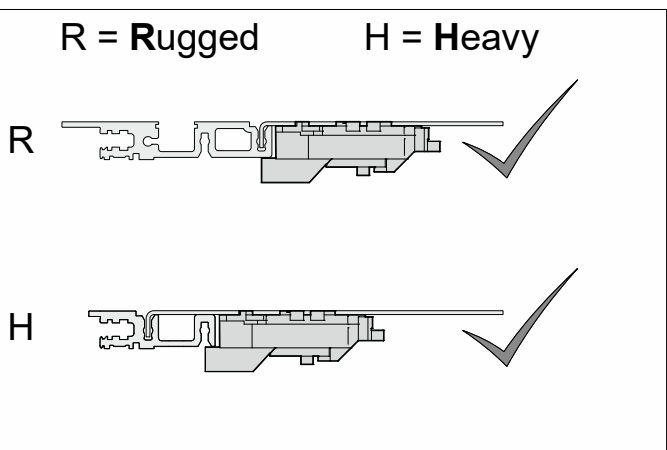
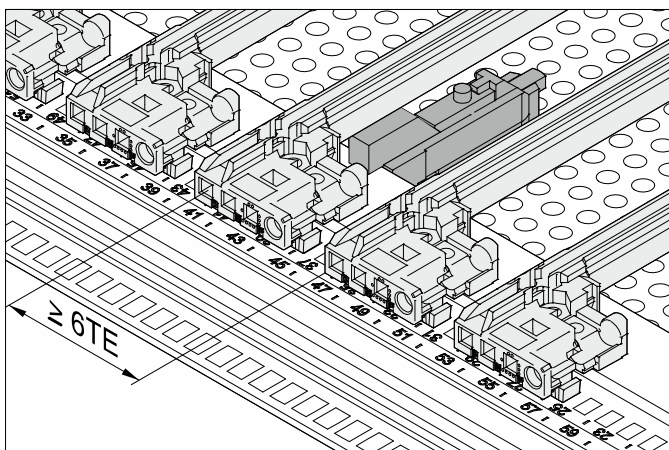
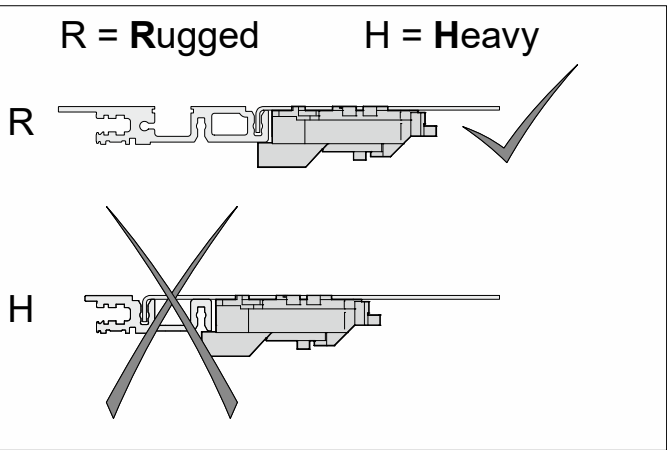
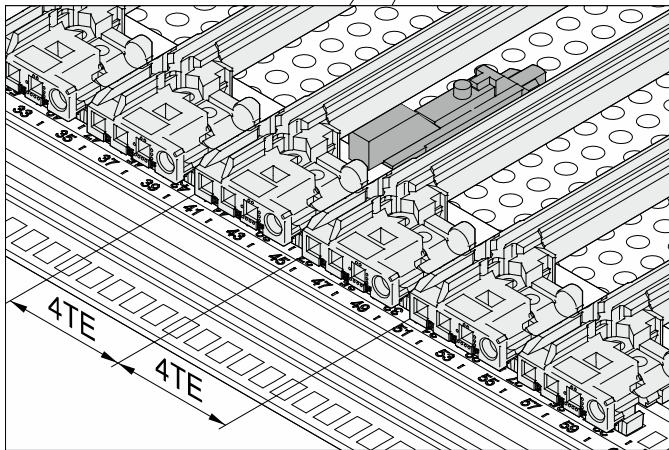
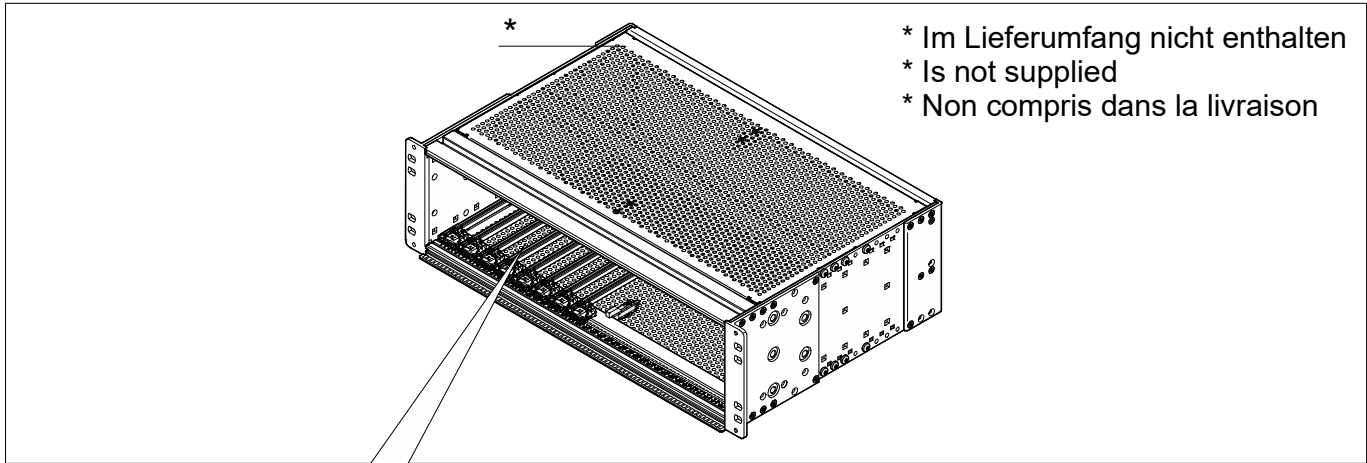

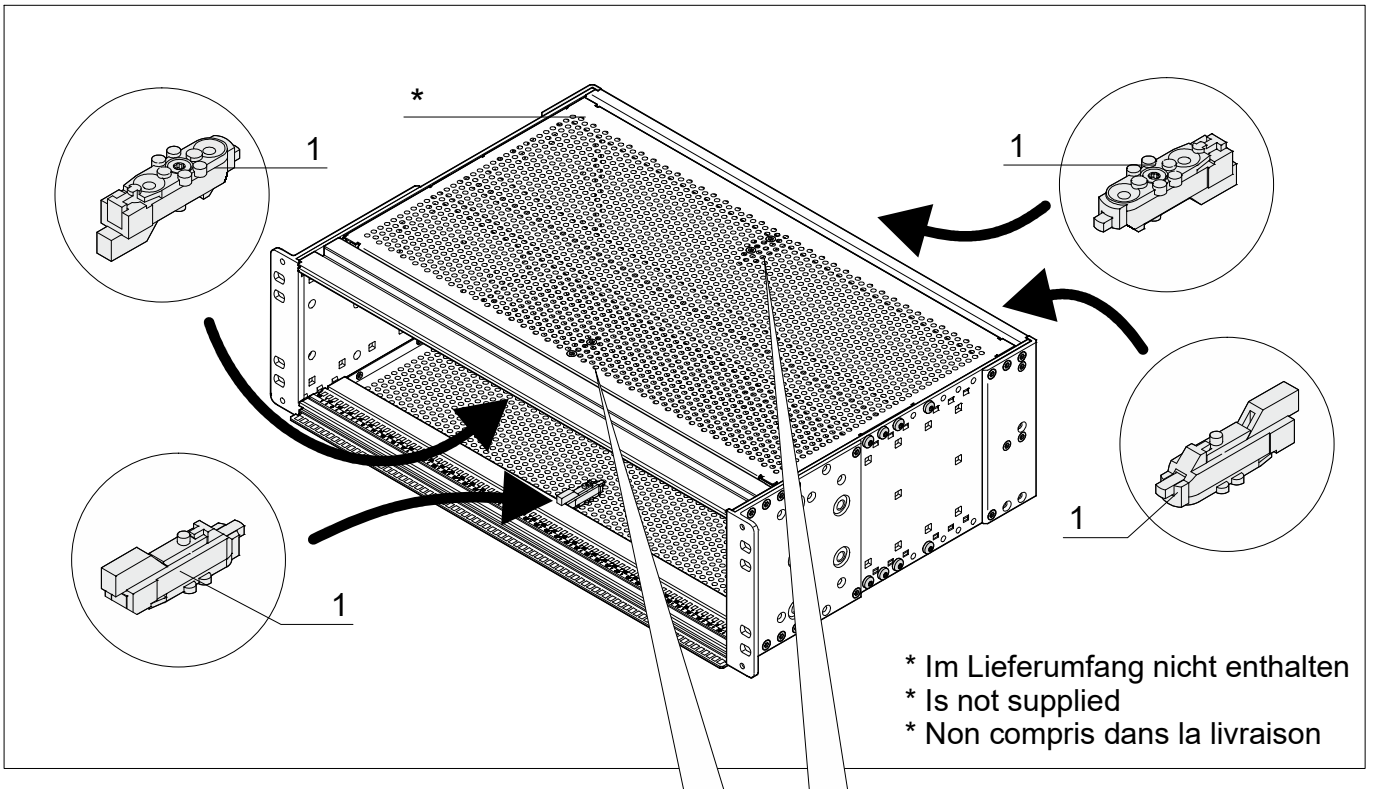

R = Rugged H = Heavy

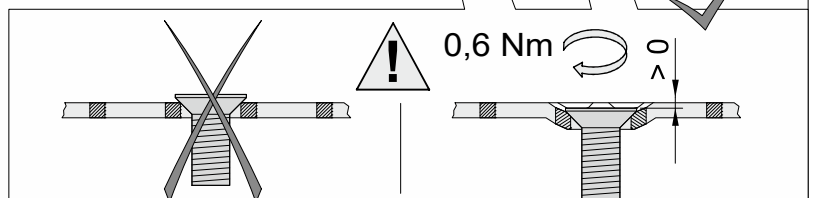
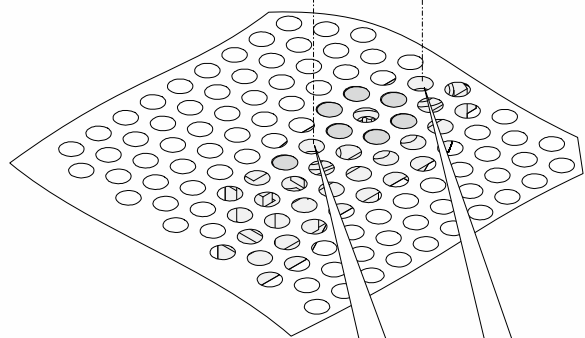
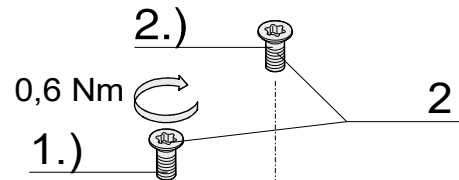
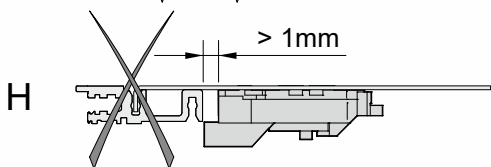
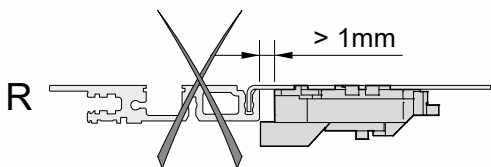
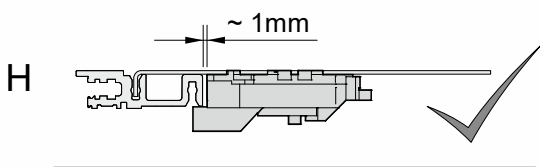
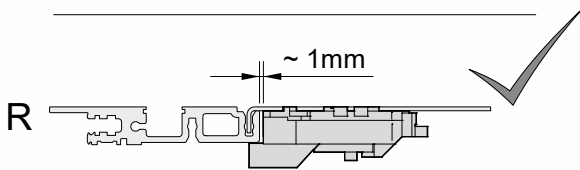
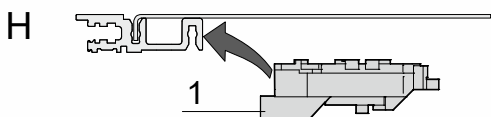
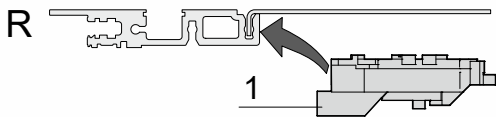

R = Rugged H = Heavy

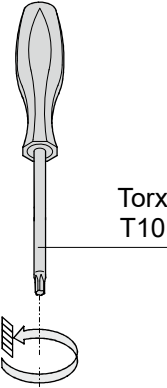
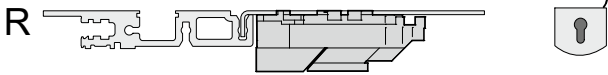
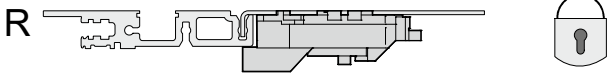

Torx
T10

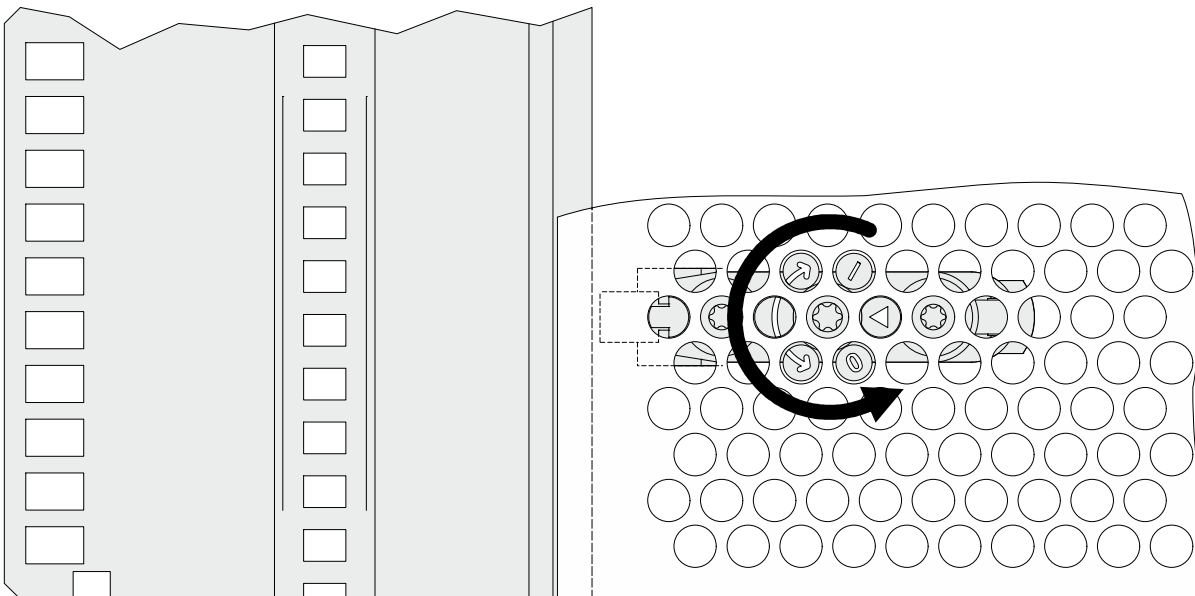
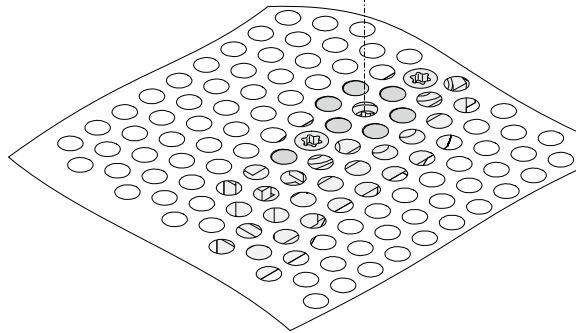

R = Rugged

H = Heavy

R

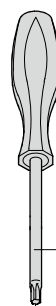
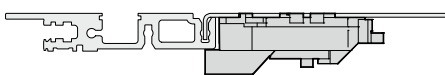

Torx
T10



1,0 Nm

