

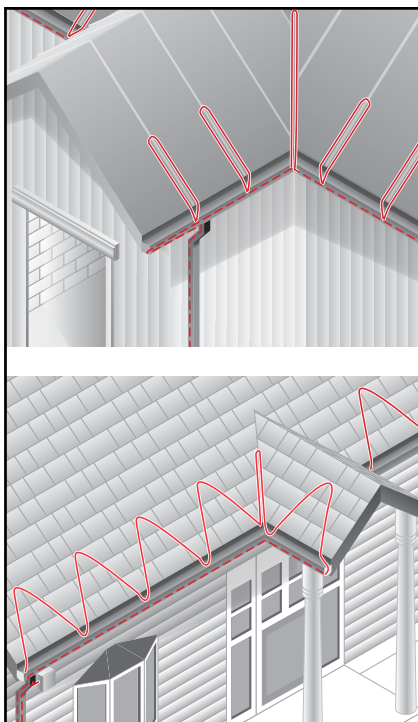

RAYCHEM

IceStop System

Installation and Operation Manual for
Roof and Gutter De-icing Systems



Important Safeguards and Warnings

WARNING: FIRE AND SHOCK HAZARD.

nVent RAYCHEM IceStop must be installed correctly to ensure proper operation and to prevent shock and fire. Read these important warnings and carefully follow all the installation instructions.

- To minimize the risk of fire from sustained electrical arcing if the heating cable is damaged or improperly installed and to comply with nVent requirements, agency certifications, and national electrical codes, ground-fault equipment protection must be used on each heating cable branch circuit. Arcing may not be stopped by conventional circuit breakers.
- Approvals and performance are based on the use of nVent RAYCHEM parts only. Do not substitute parts or use vinyl electrical tape.
- Bus wires will short if they contact each other. Keep bus wires separated.
- Connection kits and cable ends must be kept dry before and during installation.
- The black heating cable core and fibers are conductive and can short. They must be properly insulated and kept dry.
- Damaged bus wires can overheat or short. Do not break bus wire strands when scoring the jacket or core.
- Damaged heating cable or connection kits can cause electrical shock, arcing or fire. Do not attempt to repair or energize damaged cable. Remove damaged sections at once and replace them with a new length using the appropriate nVent RAYCHEM splice kit. Replace damaged connection kits.
- To minimize the risk of fire, heating cable must only be used for de-icing. Heating cable must not be installed inside buildings. All heating cable to junction box or power cable connections must be made external to the building. For connection to the power supply, an appropriately-sized power cable must be used with proper power connection accessories.

Table of Contents

1	General Information	1
	1.1 Use of the Manual	1
	1.2 IceStop Applications	1
	1.3 Safety Guidelines	2
	1.4 Typical Roof and Gutter System	3
	1.5 Approvals	6
	1.6 Warranty	6

2	Pre-Installation Checks	7
	2.1 Check Materials	7
	2.2 Connection Kits and Accessories	8
	2.3 Review the Design	12

3	Heating Cable Installation	13
	3.1 Heating Cable Handling	13
	3.2 Protecting the Heating Cable	14
	3.3 Visual Inspection	14
	3.4 Heating Cable Layout	15

4	Attachment Methods	30
	4.1 Overview	30
	4.2 Roof Attachment Methods	31
	4.3 Attachment Methods for Other Areas	36

5	Control, Monitoring and Power Distribution	40
	5.1 Control Systems	40
	5.2 Power Distribution	45

6	Commissioning and Preventive Maintenance	49
	6.1 System Start-up and Operation	49
	6.2 Insulation Resistance (Megohmmeter) Test	49
	6.3 Continuity Test	52

7	Test Procedures	53
	7.1 Tests	53
	7.2 Insulation Resistance Test – Test 1	54
	7.3 Insulation Resistance (Megohmmeter) Test	55
	7.4 Fault Location Tests	58

8	Troubleshooting Guide	62
----------	------------------------------	-----------

9	Installation and Inspection Records	68
----------	--	-----------

1

General Information

1.1 Use of the Manual

This manual covers the installation of nVent RAYCHEM IceStop roof and gutter de-icing system. The manual covers general heating cable installation procedures and specific installation details and shows available connection kits. The manual also discusses controls, testing, and periodic maintenance.

This manual assumes that the proper roof and gutter de-icing design has been completed according to the Roof and Gutter De-Icing: IceStop System Design Guide (H56070).

Only the applications described in Section 1.2 are approved by nVent for IceStop systems when used with approved nVent RAYCHEM connection kits. The instructions in this manual and the installation instructions included with the connection kits must be followed for the nVent warranty to apply. Contact your nVent representative for other applications and products.

1.2 IceStop Applications

IceStop is a roof and gutter de-icing system that provides drain paths for the following applications:

- Roofs made from standard roofing materials, including shake, shingle, rubber, tar, wood, metal, and plastic.
- Gutters made from standard materials, including metal, plastic, and wood.
- Downspouts made from standard materials, including metal and plastic.

The guide does **not** provide information for using an IceStop system for the following applications:

- Preventing snow movement on roofs—IceStop will not keep snow or ice from falling off the roof. IceStop is designed to remove melt water, not accumulated snow. Snow fences or snow guards should be used to eliminate snow movement.

1

General Information

For the names of manufacturers of snow guards or snow fences, contact your nVent representative, or contact us directly at (800) 545-6258.

- Melting snow on a roof and/or reduction of snow load—IceStop is designed to remove melt water, not accumulated snow.

If your application conditions are different, or if you have any questions, contact:



nVent

7433 Harwin Drive
Houston, TX 77036
USA

Tel: +1.800.545.6258
Fax: +1.800.527.5703
thermal.info@nVent.com
nVent.com/RAYCHEM

1.3 Safety Guidelines

The safety and reliability of any heat-tracing system depends on the quality of the products selected and the manner in which they are installed and maintained. Incorrect design, handling, installation, or maintenance of any of the system connection kits could damage the de-icing system or the roof and may result in inadequate de-icing, electric shock, or fire. To minimize these risks and to ensure that the system performs reliably, read and carefully follow the information, warnings, and instructions in this guide.

- Important instructions are marked  **Important**
- Warnings are marked  **WARNING**

1

General Information

1.4 Typical Roof and Gutter System

Ice dams can cause water ingress into buildings and generate dangerous icicles. An IceStop system can help prevent ice dams and icicles by maintaining a continuous path for melt water to drain from the roof. As long as a heated path from the roof to a safe discharge area is maintained, ice dams will not form. The IceStop system can be used on roofs and valleys and in downspouts and gutters made from all types of standard roofing materials, including metal, plastic, wood, shake/shingle, rubber, and tar.

The IceStop system is intended to provide drain paths. A typical system is shown in Figure 1.

1

General Information

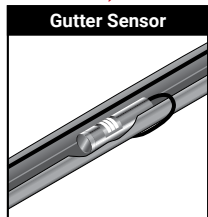
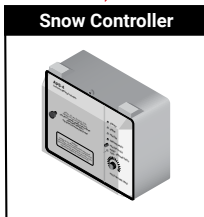
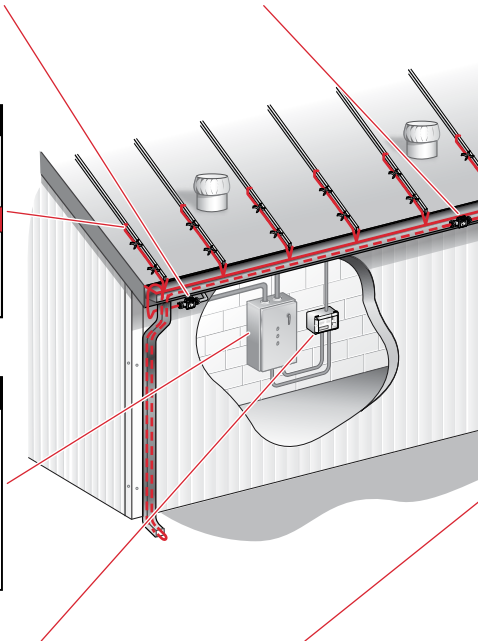
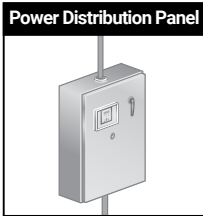
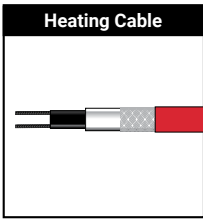
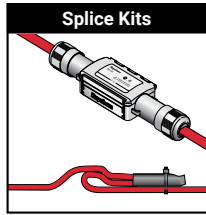
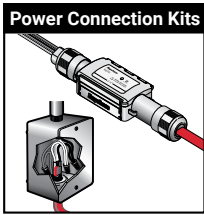

Figure 1: IceStop Roof and Gutter De-icing System

1

General Information

Attachment Kits



Tee Kits

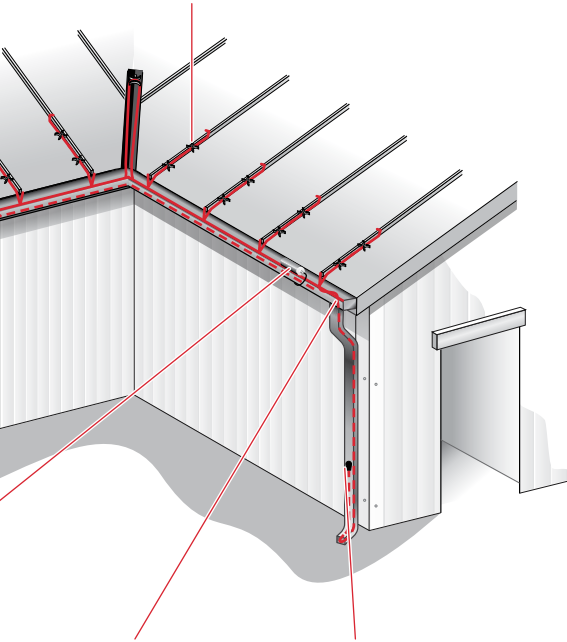
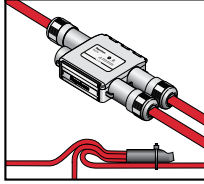

Downspout Hanger Kit



End Seal Kit

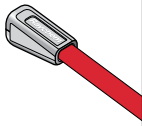

Lighted End Seal

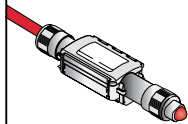

1

General Information

1.5 Approvals

The IceStop roof and gutter de-icing system is UL Listed, CSA Certified, and FM Approved for use in nonhazardous areas. nVent RAYCHEM GM-1XT and GM-2XT are also FM Approved for use in Class I, Division 2 hazardous locations.

1.6 Warranty



nVent limited standard warranty applies to all products. You can access the complete warranty on our website. To qualify for an extended 10-year warranty, register online within 30 days of installation at <https://raychem.nvent.com/en-us/support/warranty-information>

2

Pre-Installation Checks

2.1 Check Materials

If physical damage is found, the entire damaged section must be removed and a new section of heating cable spliced in, using only approved nVent RAYCHEM splice kits. Do not attempt to repair the damaged heating cable section. If the damage cannot be found, the complete circuit should be removed and replaced with new IceStop heating cable.

 **WARNING: Shock or Fire Hazard. Damaged heating cable or connection kits can cause electrical shock, arcing, and fire. Do not attempt to energize damaged heating cable or connection kits. Replace them immediately using a new length of heating cable and the appropriate IceStop accessories.**

 **Important: All heating cable to junction box or power cable connections must be made external to the building. The heating cable must not be installed inside the building. For connection to the power source, correctly sized power source wiring must be used.**

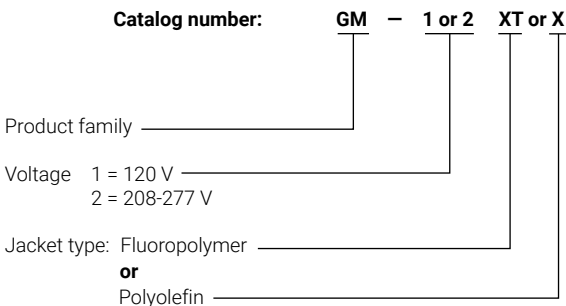

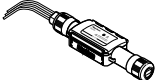
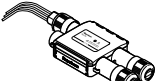
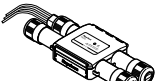
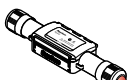
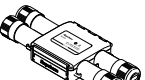

Figure 2: Catalog number

2

Pre-Installation Checks

2.2 Connection Kits and Accessories

TABLE 1: CONNECTION KITS

Catalog number	Description	Heating cable allowance ¹
Power connection		
 RayClic-PC	Quick connect power connection kit to power 1 run of heating cable. Includes 1 end seal. Standard pkg: 1	2 ft (0.6 m)
 RayClic-PS	Quick connect power connection kit to power 2 runs of heating cable. Includes 2 end seals. Standard pkg: 1	2 ft (0.6 m)
 RayClic-PT	Quick connect power connection kit to power 3 runs of heating cable. Includes 3 end seals. Standard pkg: 1	3 ft (1 m)
 RayClic-LE	Alternate lighted end seal Standard pkg: 1	2 ft (0.6 m)
 RayClic-X	Cross connection to connect four heating cables Standard pkg: 1	8 ft (2.4 m)
End seal		
 RayClic-E	Extra end seal Standard pkg: 1	0.3 ft (0.1 m)

 **Important:** With the exception of RayClic-PC, power source wiring for connection to power source not included with power connection kits.

2

Pre-Installation Checks

TABLE 1: CONNECTION KITS

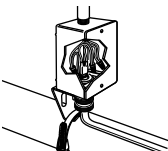
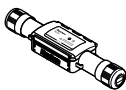
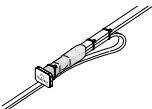
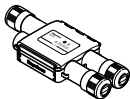
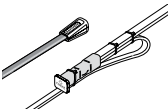
Catalog number	Description	Heating cable allowance ¹
Junction box		
	Junction box ¹ mounted HSP power connection kit. Includes 1 end seal. Standard pkg: 1	2 ft (0.6 m)
FTC-P		
Splice connection		
	Quick connect splice kit Standard pkg: 1	2 ft (0.6 m)
RayClic-S		
	Heat-shrinkable splice kit Standard pkg: 2	2 ft (0.6 m)
FTC-HST-PLUS		
Tee connection		
	Quick connect tee kit Standard pkg: 1	2 ft (0.6 m)
RayClic-T		
	Heat-shrinkable tee kit Standard pkg: 2	3 ft (0.9 m)
FTC-HST-PLUS ²		

¹ Junction box not included.



² One RayClic-E end seal is required for each FTC-HST-PLUS used as a tee kit.

 **Important: With the exception of RayClic-PC, power source wiring for connection to power source not included with power connection kits.**

2

Pre-Installation Checks

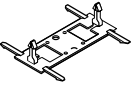
TABLE 2: ATTACHMENT ACCESSORIES

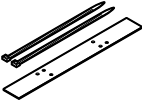
Catalog number	Description	No. of packages required
Mounting bracket		
 RayClic-SB-02	RayClic wall mounting bracket Standard pkg: 1	1 mounting bracket/ RayClic connection kit (except RayClic-E) installed on a wall
 GMK-RC	Mechanical (penetrating) roof clip Standard pkg: 50	1 box per 35' of roof edge when zig-zag layout is used
 GM-RAKE	Hanger bracket Standard pkg: 1	1 hanger per cable in downspout or as required for mechanical protection
CT-CABLE-TIE	UV-resistant cable tie Standard pkg: 100	Varies depending on installation

2

Pre-Installation Checks

Adhesives for Metal Roofs

With the adhesives that are available today, the attachment of clips to metal roofs can be as reliable as screws or nails into a wooden roof. The adhesives that perform the best allow some flexibility in the connection between the clip and the roof surface. Adhesives such as epoxies, which cure to a hard nonflexible form, should not be used. Acid-curing silicones, which are not as strong and could damage the roof, also should not be used.

The adhesives listed below have been evaluated by nVent.

TABLE 3: ADHESIVES FOR METAL ROOFS

Adhesive	Description	Times	Dispensing equipment
Momentive Performance Materials, Inc. RTV167	Neutral-cure silicone adhesive	Tooling 20 min Cure 48 hr	Caulking gun
SpeedBonder H4800	Methacrylate adhesive	Tooling 45–55 min Cure 24 hr	Two-part mixing dispenser
Plexus MA300	Methacrylate adhesive	Tooling 15 min Cure 16 hr	Two-part mixing dispenser
Plexus MA310	Methacrylate adhesive	Tooling 30 min Cure 16 hr	Two-part mixing dispenser



Important: Adhesive is not supplied by nVent. Contact the manufacturers listed for information on local distributors. Follow manufacturer's instructions for surface preparation and installation.

2

Pre-Installation Checks

Tooling time is the maximum amount of time the product is usable after being mixed. Cure time is the waiting time required before installing heating cable.

Momentive Performance Materials, Inc. RTV 167 Silicone Adhesive is a neutral-cure silicone adhesive. Contact: (800) 332-3390.

SpeedBonder H3300 and H4800 are general purpose, two-component, room-temperature curing, 1:1 mix ratio, methacrylate adhesive systems. Contact: (800) 767-8786.

Plexus MA310 and MA300 are two-component methacrylate adhesives designed for structural bonding of thermoplastic, metal, and composite assemblies. Contact: (800) 851-6692.

Please consult with a roofing contractor before purchasing and installing clips with the adhesives. It is extremely important to follow the adhesive manufacturer's instructions carefully, especially with regard to surface preparation.

2.3 Review the Design

Hold a project coordination meeting. Review the design at this meeting and ensure that the cables supplied meet the design requirements.

Plan the location of all junction boxes and supply points. Review the installation steps in Section 3 for the particular application as several trades may be involved in the system installation. Review Section 4 on attachment methods. During the meeting, discuss the role of each trade and the contractor.

3

Heating Cable Installation

3.1 Heating Cable Handling

Paying Out the Cable

Mount the reel on a holder and place it near either end of the roof area to be heated. Use a reel holder that pays out smoothly with little tension. Avoid jerking the cable while pulling.

When paying out the heating cable, AVOID:

- Sharp edges
- Excessive pulling force or jerking
- Kinking or crushing
- Walking on or running over the heating cable with equipment

Connection Kits and Accessories Installation

Start by installing connection kits and accessories in locations indicated on project drawings or as indicated in “Heating Cable Layout” beginning on the following page.

Once all clips and downspout hangers are in place, and adhesives cured if applicable, the heating cable can be installed.

Start at the end seal and work back. Be sure to leave a drip loop at connection kits so that water will not track down the heating cable into the component. Install heating cable using the sample layout shown in “Heating Cable Layout” on page 15.

- Be sure the heating cable provides a continuous path for water to flow off the roof.
- Be sure to leave drip loops where appropriate.
- Do not exceed maximum circuit length determined during design process using the Roof and Gutter De-Icing: IceStop System Design Guide (H56070).
- Be sure to loop and secure heating cable at the bottom of downspouts so that the heating cable is not exposed to mechanical damage.
- Install a UV-resistant cable tie wherever two heating cables are intended to stay together.

3

Heating Cable Installation

- Test installed heating cable for insulation resistance and continuity (see “Procedure” on page 56).

3.2 Protecting the Heating Cable

On many projects, there is a delay between installation of the heating cables and installation of heating system connection kits. If this is the case, take the following precautions to protect the heating cables and components.

- Keep covers on junction boxes to prevent moisture from entering them.
- Mechanically protect the heating cables so that they cannot be damaged by being walked on, run over, painted, sandblasted, burned, welded, or cut.
- Do not allow ends of heating cable to be exposed to moisture.

3.3 Visual Inspection

A visual inspection of the IceStop system should be made after installation is complete. This inspection will ensure:

- Proper installation of the system
- No mechanical damage (cuts, burns, scrapes, etc.) to cable sustained during installation
- Proper heating cable width and height
- Proper heating cable fastening

Further visual inspection of the IceStop system is recommended following any further work performed on building that may cause damage to the system. Further work may include, but is not limited to, roofing, gutter or downspout maintenance or repair, manual snow removal, installation of mechanical, electrical or communications equipment such as antennas, receivers, or air conditioning units. Also, if roof sustains damage of any kind, visual and functional inspection of IceStop system is recommended.

3

Heating Cable Installation

3.4 Heating Cable Layout

Heating cable layout depends primarily on the roof type and roof features. The following sections show typical layouts on standard roof types:

- “Sloped Roof – Standard” on page 16
- “Sloped Roof – Standing Seam” on page 18
- “Flat Roof” on page 20
- “Sloped Roof without Gutters” on page 21
- “Roof Valleys” on page 23
- “Roof/Wall Intersections” on page 24
- “Gutters” on page 25
- “Downspouts” on page 28

 **Important:** For optimum performance, the heating cable should be in contact with snow or ice. Installing the heating cable under the roofing or the roofing materials will reduce the efficiency of the heating system. Please contact nVent for assistance.

Figure 3 and Figure 4 following illustrate several important terms:

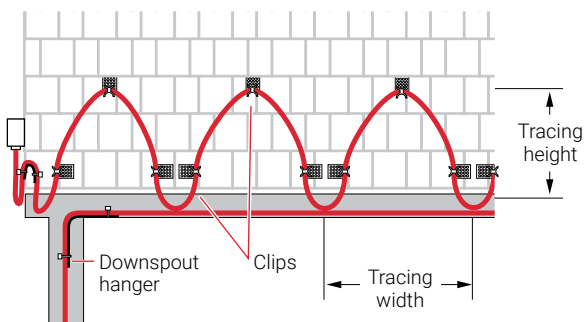

Figure 3: Front view of roof with IceStop system

3

Heating Cable Installation

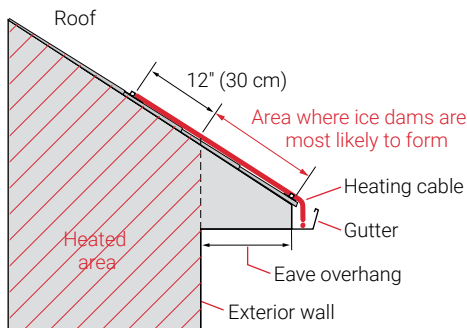

Figure 4: Side view of roof with IceStop system

Sloped Roof – Standard

For sloped roofs, ice dams may form at the roof edge. To maintain a continuous path for melt water runoff, route the heating cable in a zig-zag pattern as shown in Figure 5 and follow the appropriate attachment recommendations in “Attachment Methods”, page 30. Additional heating cable may be needed for other gutters, downspouts, and valleys.

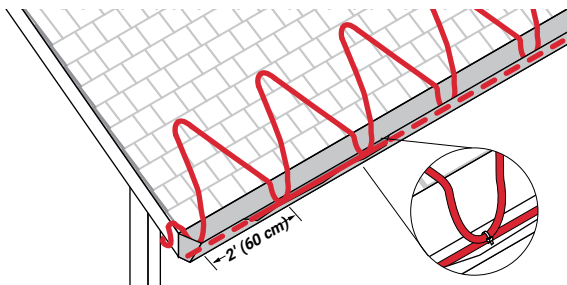

Figure 5: Layout in a zig-zag pattern

- Run heating cable up the roof until it is 12 inches (30 cm) past the exterior wall into the heated area (see Figure 4).
- Install the heating cable on the roof in a zig-zag pattern as shown in Figure 5.

3

Heating Cable Installation

- Be sure that the heating cable extends all the way down to meet with the run of heating cable in the gutter. This will ensure that there is a continuous path where the melted water can flow. Attach the heating cables together with UV-resistant cable ties.
- Table 4 lists the required amount of heating cable required for a standard sloped roof.

TABLE 4: ICESTOP HEATING CABLE LENGTH FOR SLOPED ROOF – STANDARD

Eave overhang distance	Tracing width	Tracing height	Feet of heating cable per foot of roof edge
0 in (0 cm)	24 in (60 cm)	12 in (30 cm)	2.5 ft (0.76 m)
12 in (30 cm)	24 in (60 cm)	24 in (60 cm)	3.2 ft (0.98 m)
24 in (60 cm)	24 in (60 cm)	36 in (90 cm)	4.2 ft (1.28 m)
36 in (90 cm)	24 in (60 cm)	48 in (120 cm)	5.2 ft (1.59 m)

 **Important: Attachment methods are not shown in Figure 5. For attachment methods, proceed to “Attachment Methods”, page 30.**

OTHER CONSIDERATIONS

- Use a snow fence or snow guards (not shown) to prevent snow from sliding. Extend heating cable above the snow fence at least 6 inches (15 cm).
- If there are no gutters, refer to “Heated Drip Edges” on page 38, for information on how to install heating cable for this application.
- It is not always necessary to run heating cables on the roof. If you do not experience ice dams on the roof, installing heating cables only in the gutters and downspouts may be sufficient.

 **Important: Heating cable must not be installed inside buildings. Some application configurations may require appropriately-sized power source wiring and proper connection accessories for connection from power source to service area.**

3

Heating Cable Installation

Sloped Roof – Standing Seam

For sloped standing seam metal roofs, ice dams may form at the roof edge. To maintain a continuous path for melt water to run off, route the heating cable along the seams as shown in Figure 6 and follow the attachment recommendations in “Attachment Methods”, page 30. Additional heating cable may be needed for gutters, downspouts, and valleys and is covered elsewhere in Section 3.

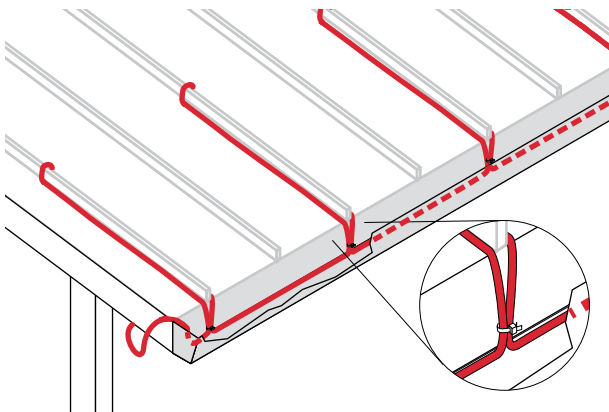

Figure 6: Layout on a standing seam roof

- Run the heating cable up the seam until it is 12 inches (30 cm) past the exterior wall and into a heated area, Figure 4 on page 16.
- Run the heating cable up one side of the seam, loop it over to the other side, and return it to the bottom of the gutter. Continue along the bottom of the gutter to the next seam and repeat the process. If the seams are more than 24 inches (60 cm) apart, trace every seam.

3

Heating Cable Installation

TABLE 5: ICESTOP HEATING CABLE LENGTH FOR SLOPED ROOF – STANDING SEAM

Eave overhang distance	Standing seam spacing	Tracing height	Feet of heating cable per foot of roof edge
12 in (30 cm)	18 in (45 cm)	24 in (60 cm)	2.8 ft (2.8 m)
24 in (60 cm)	18 in (45 cm)	36 in (90 cm)	3.6 ft (3.6 m)
36 in (90 cm)	18 in (45 cm)	48 in (120 cm)	4.3 ft (4.3 m)
12 in (30 cm)	24 in (60 cm)	24 in (60 cm)	2.4 ft (2.4 m)
24 in (60 cm)	24 in (60 cm)	36 in (90 cm)	2.9 ft (2.9 m)
36 in (90 cm)	24 in (60 cm)	48 in (120 cm)	3.6 ft (3.6 m)

- On standard systems, the length of heating cable needed for the roof and gutter can be determined by the formula:
- Heating cable length = [2 x no. of seams traced x (trace height + length from roof top edge to gutter bottom)] + length of gutter/roof edge

Additional heating cable will be needed for connection kits and downspouts.



Important: Attachment methods are not shown in Figure 6. For attachment methods, proceed to “Attachment Methods”, page 30.

OTHER CONSIDERATIONS

- Use a snow fence or snow guards (not shown) to prevent snow from sliding. Extend heating cable above the snow fence at least 6 inches (15 cm).
- If the roofing materials continue down the fascia, contact your local nVent representative or nVent directly for design assistance.
- If there are no gutters, refer to “Heated Drip Edges” on page 38, for information on how to install heating cable for this application.
- It is not always necessary to run heating cables on the roof. If you do not experience ice dams on the roof, installing heating cables only in the gutters and downspouts may be sufficient.

3

Heating Cable Installation

Flat Roof

Ice dams may occur on flat roofs at the edge flashing and at drains. Flat roofs are typically pitched toward drains and these paths often become obstructed by snow and ice. To maintain a continuous path for melt water to run off, route the heating cable as shown in Figure 7 and follow the appropriate attachment recommendations in "Attachment Methods", page 30. Additional heating cable may be needed for downspouts.

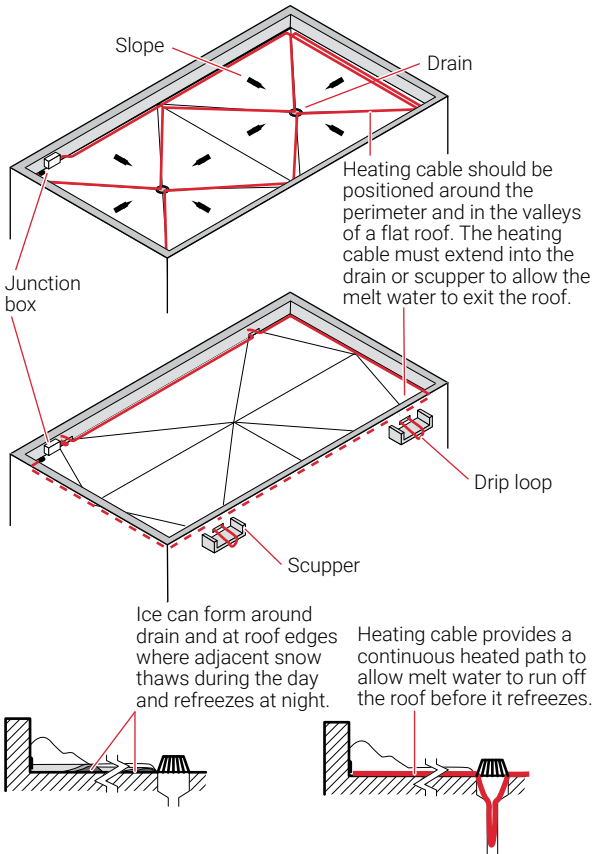

Figure 7: Layout on a flat roof

3

Heating Cable Installation

- Place heating cable around perimeter.
- Trace valleys from perimeter to drain.
- Extend heating cable into internal downspouts at least 12 inches (30 cm) into heated space.
- External downspouts and scuppers must be treated carefully. A path must be provided for the valley/perimeter heating cable to the point of discharge (see Figure 15 on page 28).
- To avoid damage, do not walk on the heating cable.

Sloped Roof Without Gutters

When gutters are not used on a building, ice dams may form at the roof edge. To maintain a continuous path for melt water to run off, a drip loop or heated drip edge may be used. Drip loops and drip edges allow water to drip free of the roof edge.

Route the heating cable as shown in Figure 8 or Figure 9 below and follow the appropriate attachment recommendations in “Attachment Methods”, page 30. Additional heating cable may be needed for valleys.

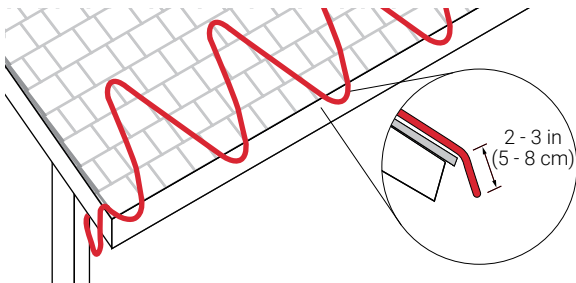

Figure 8: Layout for heated drip loops

3

Heating Cable Installation

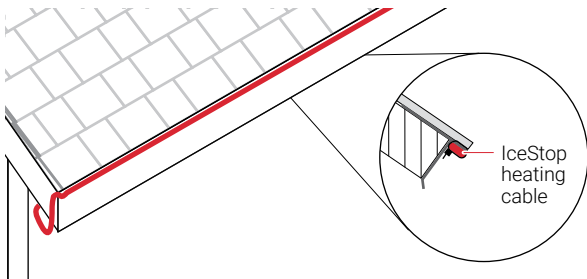



Figure 9: Layout for heated drip edge

 **Important:** Attachment methods are not shown in the above illustrations. For attachment methods, proceed to “Attachment Methods”, page 30.

OTHER CONSIDERATIONS

- Use a snow fence or snow guards to prevent snow from sliding (not shown). Extend heating cable above the snow fence a minimum of 6 inches (15 cm).
- Ice will build up on the surfaces below the drip loop or drip edge if gutters are not used.
- Ice may also build up on the vertical surfaces if there isn't a sufficient overhang or if there is a strong wind. Use of a gutter system will prevent this ice buildup.

3

Heating Cable Installation

Roof Valleys

Ice dams may form at the valley on a roof where two different slopes meet. To maintain a continuous path for melt water, run the heating cable up and down the valley as shown in Figure 10 and follow the appropriate attachment recommendations in “Attachment Methods”, page 30. Additional heating cable may be needed for the roof surface, gutters, and downspouts.

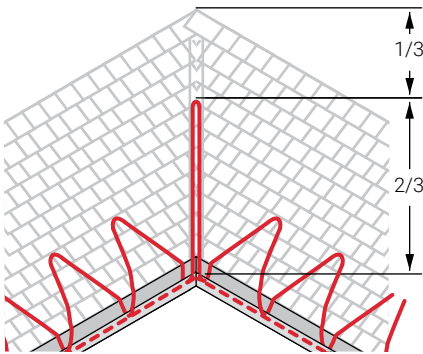

Figure 10: Layout for a roof valley

- Trace two-thirds of the way up each valley with a double run of heating cable (loop up and back once).
- The heating cable must extend into the gutter. If you don't have gutters, the heating cable should extend over the edge 2 to 3 inches (5 to 8 cm) to form a drip loop.
- For attachment methods, proceed to “Attachment Methods”, page 30.

3

Heating Cable Installation

Roof/Wall Intersections

Roof/wall intersections can be treated in the same manner as valleys. Snow has a tendency to collect at this interface. Providing a loop of heating cable two-thirds of the way up the slope will provide a path for the extra melt water in this area to escape.

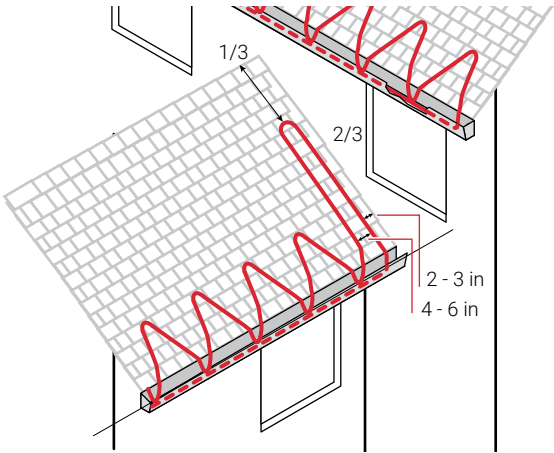

Figure 11: Layout for a roof/wall intersection

- Extend a loop of heating cable two-thirds of the way up the slope adjacent to the wall.
- Position the closest heating cable approximately 2 to 3 inches (5 to 8 cm) from the wall. Position the second heating cable 4 to 6 inches (10 to 16 cm) from the first.

3

Heating Cable Installation

Gutters

Ice may accumulate in gutters and at the roof edge. To maintain a continuous path for melt water to run off, route the heating cable as shown in Figure 12 below. Additional heating cable may be needed for the roof surface, downspouts, and valleys.

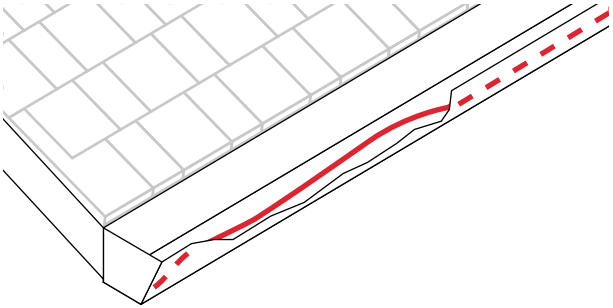

Figure 12: Layout in standard gutters—up to 6 in (16 cm) wide

- Use one run of heating cable in the gutter.
- No attachment to gutter is normally required. If attachment is desired, use a roof clip such as a nVent RAYCHEM GMK-RC clip or CCB.
- Continue heating cable down the inside of the downspout. See “Downspouts” on page 28, for more information.

3

Heating Cable Installation

In wide gutters, snow and ice can bridge over the tunnel created by a single heating cable and prevent melt water from getting into the gutter and downspouts. To maintain a continuous path for melt water to run off, run the heating cable in the gutter as shown in Figure 13 below and follow the appropriate attachment recommendations in "Attachment Methods", page 30. Additional heating cable may be needed for the roof surface, downspouts, and valleys.

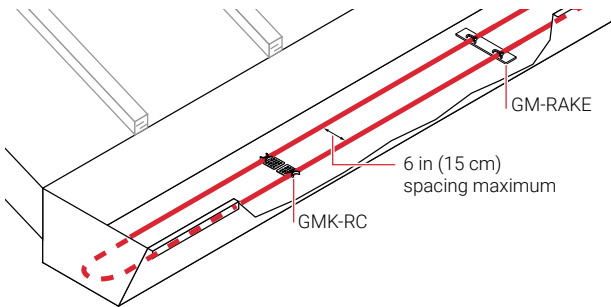

Figure 13: Layout in wide gutters—6 to 12 in wide

Drainage and Trench Drains

Drains and Trenches at or below the grade level can have debris and other organic waste from the storm water. For mechanical protection, the heating cable should be secured using criss-cross cable ties, less than 36 inches apart, on metal bars, nVent RAYCHEM GM-Rake, plastic strapping or wire mesh. The cable could also be secured using nVent RAYCHEM GMK-RC or metal brackets such as CCB or panels such as nVent RAYCHEM RIM as shown below. Approved connection kits such as nVent RAYCHEM RayClic, FTC or WPCK should be used. When transitioning from trench to a junction box use a conduit as shown below. Heating cable should be looped below the frost line in the drain.

⚠ WARNING: Heating cable must not be installed in building, in conduit or under any form of insulation to minimize the risk of fire.

3

Heating Cable Installation

⚠ WARNING: It is prohibited to install heating cable in conduit under any form of insulation.

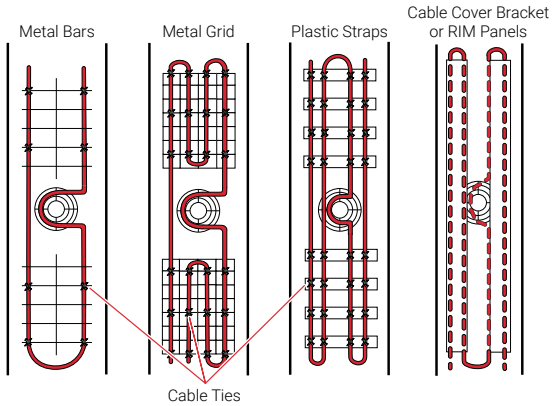

Installation of GM-XT cable in trench drains using metal bars/grids, plastic strapping and Cable Cover Bracket or RIM Panels system

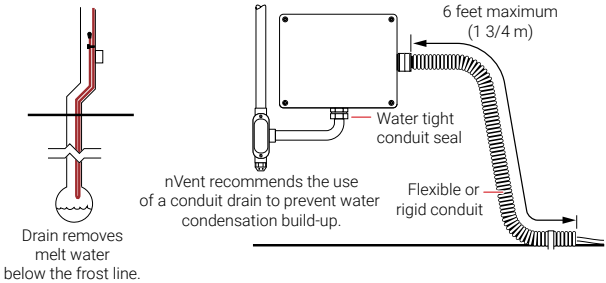

Figure 14: Installation of IceStop cable in trench drains

3

Heating Cable Installation

Downspouts

Ice may form in downspouts and prevent melt water from escaping from the roof. To maintain a continuous path for melt water to run off, run the heating cable inside the downspout to the end as shown in Figure 15 and Figure 16 below. Follow the appropriate attachment recommendations in "Attachment Methods", page 30. Additional heating cable may be needed for the roof surface, gutters, and valleys.

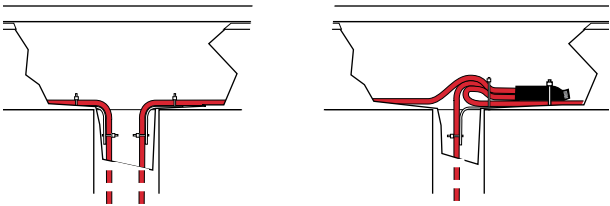

Figure 15: Heating cable at top of downspout

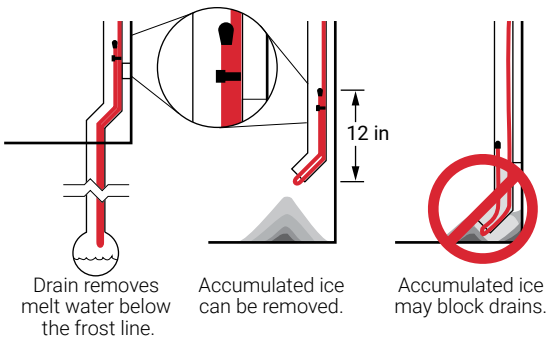

Figure 16: Heating cable at bottom of downspout

3

Heating Cable Installation

- If the downspout ends underground, the heating cable should extend into a heated area or below the frost line.
- For low-water-flow situations, teeing the heating cable so that a single run goes down the downspout is usually sufficient. For high-water-flow situations, where ambient temperatures often fall below -10°F (-23°C), or where it isn't convenient to tee the heating cable, use two runs by running the heating cable down to the bottom and then back to the top.
- Leave drip loops below the downspout at bottom.
- If a single run of heating cable is used, the end seal should be looped back up at least 12 inches (30 cm) inside the downspout.
- If the downspout ends near the ground, water will refreeze on the ground and build up around the downspout, eventually blocking the opening.

OTHER CONSIDERATIONS

To prevent mechanical damage, do not leave the end seal exposed at the end of the downspout.

4

Attachment Methods

4.1 Overview

Heating cable attachment depends primarily upon the roof type. The following table shows the recommended attachment methods for typical roof materials and roof areas.

TABLE 6: ATTACHMENT METHODS FOR TYPICAL ROOFS

Roof material	Recommended attachment method	Alternate attachment method
Shake/shingle	"Mechanical Attachment" on page 31	
Rubber/membrane	"Belt Loop Approach" on page 34	"Adhesive Attachment" on page 32
Metal	"Adhesive Attachment" on page 32	"Mechanical Attachment" on page 31 "Belt Loop Approach" on page 34
Wood	"Mechanical Attachment" on page 31	
Other	Contact nVent for assistance	

Area	Attachment method
Gutters	Recommend using hanger clips glued to gutter if possible for security (see page 36)
Downspouts	Downspout hangers (page 37)
Drip edges	Attached to a flat sheet or standard drip edge, or installed in formed sheet metal (see page 38)
Component locations	Drip loops (page 39)
Roof edges with no gutter	Drip loops (page 39)

4

Attachment Methods

4.2 Roof Attachment Methods

Mechanical Attachment

One of the most common attachment methods is to use a GMK-RC roof clip. It can be used on all surfaces that can be nailed or screwed into.

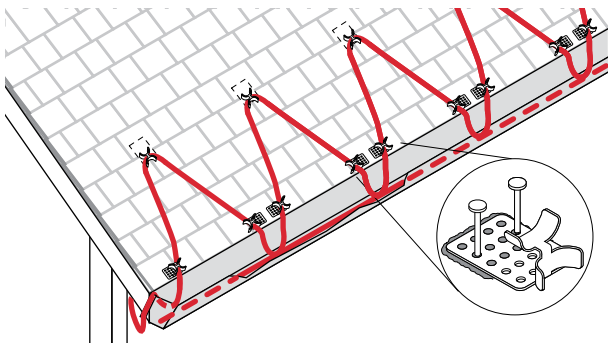

Figure 17: GMK-RC mechanical attachment

- The GMK-RC roof clips are used to secure IceStop heating cable. This multipurpose bracket attaches with screws, nails, or adhesive to many types of roofs and gutters.
- After determining the heating cable layout, fasten the clips to the roof before installing the heating cable. If using nails or screws, apply sufficient water-sealing material around the clips and nails or screws to prevent roof leaks.
- Thread the heating cable into the clips. Use additional clips wherever the heating cable may be subject to abrasion from movement.
- Use pliers to close the clamps, being careful not to crush the heating cable.
- One box of 50 GMK-RC clips is sufficient to attach the heating cable on 35 feet (11 m) of roof edge using a serpentine layout. Your layout may require additional clips.
- For layouts other than the standard serpentine, use one clip for each 5 to 10 feet (1.5 to 3 m) of unsupported heating cable and at every change of heating cable direction.

4

Attachment Methods

- For standard sloped roofs, the loops of heating cable being serpentine on the roof should be attached to the heating cable run in the gutter using UV resistant cable ties.
- For standing seam roofs, the heating cable should be cable-tied together at the bottom of the seam.

Adhesive Attachment

For roofs where penetrating attachments are not desired, use the GMK-RC clip attached by adhesive.

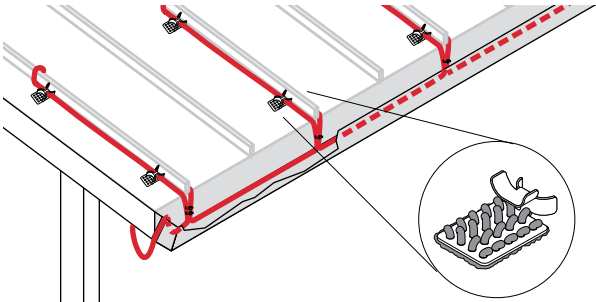

Figure 18: GMK-RC adhesive attachment

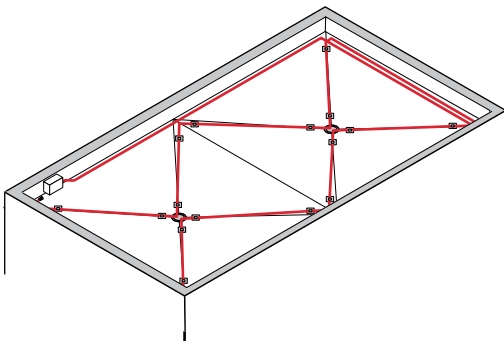

Figure 19: GMK-RC clip on flat roof

4

Attachment Methods

- The GMK-RC roof clips are used to secure IceStop heating cable. The clip attaches with adhesive (not supplied by nVent) to many types of roofs and gutters.
- Several adhesives are recommended by nVent. See Table 3 on page 11 of this manual or contact nVent for alternatives.
- On a standing seam roof, use four clips on each seam being traced. On a flat surface, use one clip for every 5 to 10 feet (1.5 to 3 m) of unsupported heating cable and at every change of direction.
- Follow all recommendations from the adhesive manufacturer with regard to cleaning and preparing the roof surface for the adhesive.
- After determining the heating cable layout, fasten the clips to the roof with the adhesive and allow the adhesive to cure before installing the heating cable.
- Thread the heating cable through the clips. Use additional clips wherever the heating cable may be subject to abrasion from movement.



Important: How well the adhesive holds can be strongly affected by how well the surface to which it will adhere is prepared and by what type of adhesive is used. Be sure to follow the recommendations of the adhesive manufacturer.

4

Attachment Methods

Belt Loop Approach

With the belt loop approach, strips of roofing materials are fastened to the roof using standard means for that particular type of roof. The heating cable is attached with a UV-resistant cable tie to the loop formed by this material.

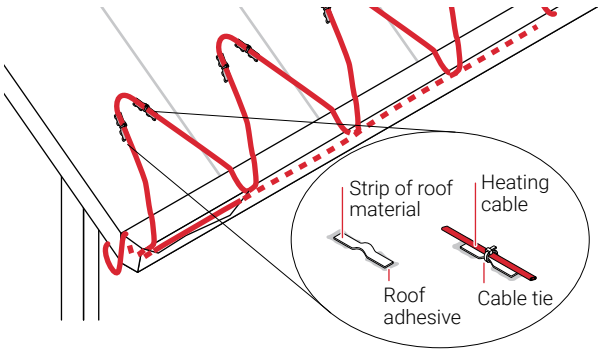

Figure 20: Belt loop approach on a sloped roof

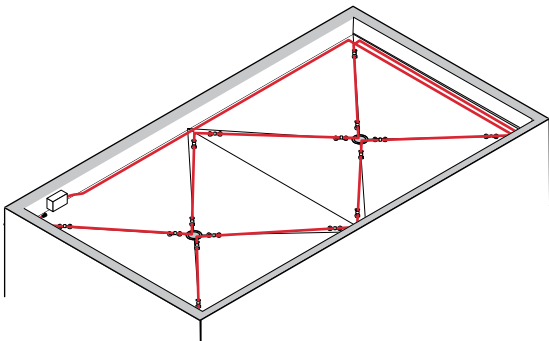

Figure 21: Belt loop approach on a flat roof

- The belt loop method of securing the IceStop heating cable involves using a small piece of roofing material to form a "belt loop."
- Use at least one belt loop for every 5 to 10 feet (1.5 to 3 m) of unsupported heating cable and at every heating cable change of direction.

4

Attachment Methods

- After determining the heating cable layout, fasten each end using standard means for that particular type of roof. Examples of this would be attaching with solder on a copper roof, adhesive on a membrane roof, or tar on an asphalt roof.
- The heating cable is attached with a UV-resistant cable tie to the loop formed by this material.
- Use additional clips wherever the heating cable may be subject to abrasion from movement.

Alternate Attachment Methods

nVent attachment clips were developed as an easy way to provide enough support for the heating cable without crimping, crushing, or otherwise damaging the heating cable and without applying any chemicals or adhesives directly to the heating cable. Other means may be used to attach the heating cable as long as they:

- Do not crush, crimp, cut, or otherwise damage the heating cable. Damage to the heating cable could cause the system to fail, and may result in electric shock or fire.
- Do not apply adhesives or other chemicals directly to the heating cable. Many adhesives will not stick to the outer jacket, which could cause the attachment method to fail, and may result in inadequate drain paths.
- Provide enough strength to support the heating cable on the roof and any load from snow that collects on the system. If the attachment method is not strong enough, the heating cable could come loose and fall off.

One method sometimes used is to attach the heating cable with a UV-resistant cable tie to a bracket, rod, or cable that is installed to support the heating cable. The brackets, rods, or cables are then attached to the roof through whatever means are appropriate for the situation and can support the weight of the heating cable.

4

Attachment Methods

4.3 Attachment Methods for Other Areas

Gutters

The IceStop heating cable is not normally attached to the gutter.

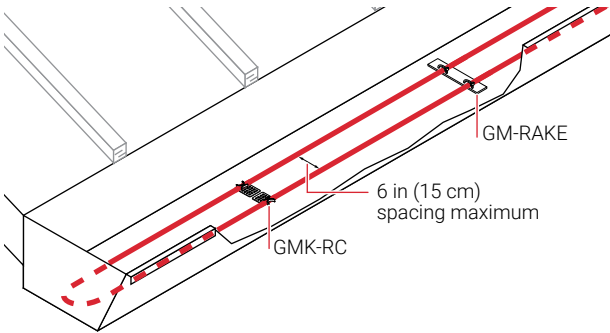

Figure 22: GMK-RC clip on a gutter

- Attachment is not generally required for standard gutters. If attachment is desired, such as in high-wind areas, use GMK-RC adhesive-mounted attachment clips. Several different adhesives are recommended by nVent. See Table 3 on page 11.
- For large gutters (6 to 12 inches wide [15 cm to 30 cm]), use two runs of heating cable separated by GMK-RC roof clips. It is not necessary to attach the clips to the gutter. Use one pair of GMK-RC roof clips for every 10 feet (3 m).

4

Attachment Methods

Downspouts

The IceStop heating cable needs to be attached at the top of each downspout using one GM-RAKE downspout hanger per heating cable. The GM-RAKE downspout hanger clamps around the heating cable.

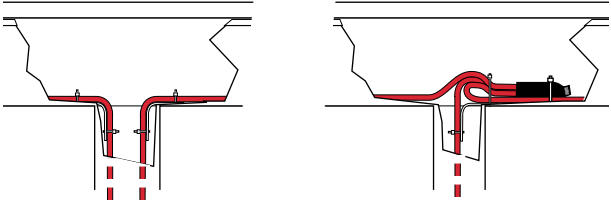

Figure 23: GM-RAKE downspout hangers

- GM-RAKE downspout hangers protect the heating cable from damage from sharp edges and also provide support for the weight of the heating cable.
- Use two GM-RAKE downspout hangers for double-traced downspouts.

4

Attachment Methods

Heated Drip Edges

When installing a heated drip edge, you can attach the heating cable to the roof's drip edge or to a flat sheet of sheet metal with a UV-resistant cable tie, or place the heating cable in a formed (J-channel) piece of sheet metal.

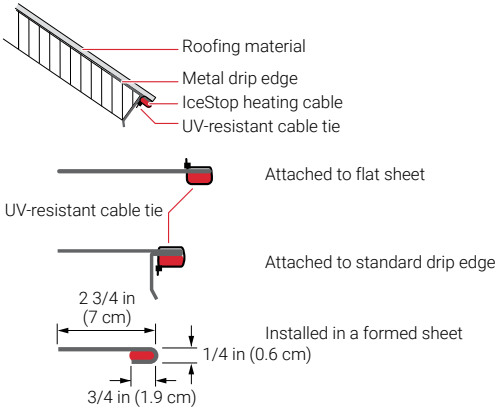

Figure 24: Heated drip edge attachment guidelines

- The illustrations above are guidelines for heating cable attachment in a heated drip edge application. nVent does not manufacture drip edge attachment clips.
- Use 20-gauge or thicker corrosion-resistant sheet metal.
- Contact your nVent representative or nVent directly for specific recommendations.

Drip Loops

Drip loops are used where connection kits are located in the system, and at roof edges where no gutter is installed. The drip loops allow melt water to drip free of the heating cable.

⚠ WARNING: Appropriately-sized power source wiring and proper power connection accessories may be required for power connection from power source to service area. Heating cables must not be installed inside buildings. All heating cable to junction box or power connections must be made external to buildings to minimize the danger of fire.

4

Attachment Methods

ROOF EDGE WITH NO GUTTER

Where no gutter is installed, a drip loop should be installed at the roof edge to allow melt water to drip free of the roof. No special attachment is necessary for heated drip loops. Use the same attachment as appropriate for your roof type; just make sure the heating cable extends 2 to 3 inches (5 to 8 cm) from the roof edge.

CONNECTION KITS

Drip loops are used where the heating cable enters a power connection, tee, or splice, to keep water from tracking into the component. No special attachment is necessary.

 **Important: Correctly sized power source wiring, suitable for the electrical load, must be used to connect the heater cable to the power source wiring where the power source is located within the building. The heating cable must not be installed inside the building.**

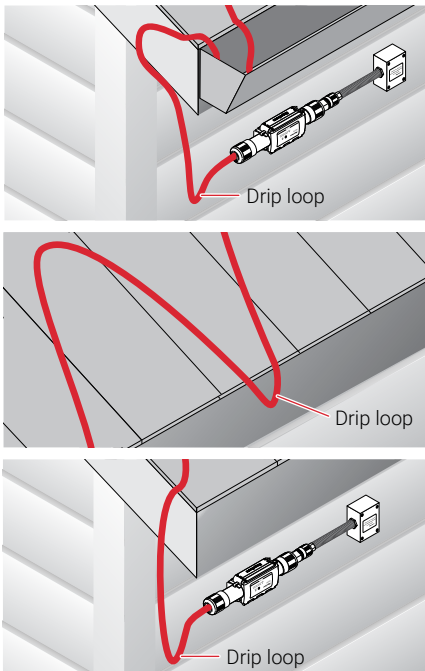

Figure 25: Drip loops

5

Control, Monitoring and Power Distribution

5.1 Control Systems

Three control methods are commonly used with roof de-icing systems:

- Manual control
- Ambient thermostat
- Automatic moisture/temperature controller

All three methods require contactors if any significant length of heating cable is being used. The contactor must be sized to carry the load. Each method offers a trade-off of initial cost versus energy efficiency and ability to provide effective de-icing. If the system is not energized when needed, ice will form. If the system is energized when de-icing is not needed, there will be unnecessary power consumption. Choose the control method that best meets the project performance requirements. Contact your nVent representative for details.

For Class I, Division 2 hazardous locations, use an agency-approved controller or thermostat suitable for the same area use.

Manual Control

A manually controlled system is operated by a switch that controls the system power contactor. This method requires constant supervision to work effectively.

The type of control you select will affect power consumption and ensure the heating cable is on when needed.

Ambient Thermostat

When an ambient sensing thermostat is used, the roof and gutter system will be energized when the ambient temperature is below freezing. This will ensure the heating cable is energized any time the water might freeze.

5

Control, Monitoring and Power Distribution

TABLE 7: CONTROL SYSTEMS

Description

Electronic thermostats and accessories



ECW-GF

Electronic ambient sensing controller with 30-mA ground-fault protection. The controller can be programmed to maintain temperatures up to 200°F (93°C) at voltages from 100 to 277 V and can switch current up to 30 Amperes. The ECW-GF is complete with a 25-ft (7.6-m) temperature sensor and is housed in a Type 4X rated enclosure. The controller features an AC/DC dry alarm contact relay.

An optional ground-fault display panel (ECW-GF-DP) can be added to provide ground-fault or alarm indication in applications where the controller is mounted in inaccessible locations.

5

Control, Monitoring and Power Distribution

TABLE 7: CONTROL SYSTEMS

Snow melting controllers



APS-3C

Automatic snow melting controller housed in a TYPE 3R enclosure provides effective, economical automatic control of all snow melting applications. CSA Certified, c-UL-us Listed, available in 120 V and 208-240 V, 50/60 Hz models, 24-Amp DPDT output relay, adjustable hold-on timer.

Enclosure dimensions: 11-1/2 in x 9-1/8 in x 6-9/16 in (292 mm x 232 mm x 167 mm)



APS-4C

Automatic snow melting controller housed in a TYPE 3R enclosure provides effective, economical automatic control of all snow melting applications. The APS-4C operates up to ten SC-40C satellite contactors for larger loads. CSA Certified, c-UL-us Listed, available in 277 V single-phase, and 208/240, 277/480, and 600 V three-phase models, built-in 3-pole 50-Amp contactor, integral 30-mA ground-fault circuit interrupter, adjustable hold-on timer.

Enclosure dimensions: 11-1/2 in x 9-1/8 in x 6-9/16 in (292 mm x 232 mm x 167 mm)



SC-40C

Satellite contactor power control peripheral for an APS-4C snow melting controller, housed in a TYPE 3R enclosure. CSA Certified, c-UL-us Listed, available in 277 V single-phase, and 208/240, 277/480, and 600 V three-phase models, built-in 3-pole 50-Amp contactor, integral 30-mA ground-fault circuit interrupter.

Enclosure dimensions: 11-1/2 in x 9-1/8 in x 6 in (292 mm x 232 mm x 152 mm)

5

Control, Monitoring and Power Distribution

TABLE 7: CONTROL SYSTEMS

Snow melting and gutter de-icing controllers

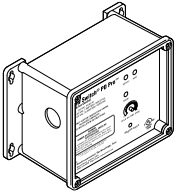

PD-Pro

Automatic gutter de-icing controller in a Type 4X enclosure that interfaces with up to two snow and ice sensors (any combination of Snow Owl, GIT-1, or SIT-6E), sold separately. The controller has an adjustable Hold-On timer that continues heater operation up to 8 hours after the sensors stop detecting snow or ice to ensure snow and ice is completely melted. The Heater Cycle toggle switch allows for manual activation or cancellation of heater operation. Controller is c-UL-us Listed and is available for 120-277 V single-phase supply with 24-Amp relay.

Enclosure dimensions: 5 1/2 in x 8 1/8 in x 4 3/8 in (140 mm x 206 mm x 111 mm)

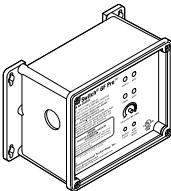

GF-Pro

Automatic gutter de-icing controller with integrated 30-mA Ground-Fault Equipment Protection (GFEP) in a Type 4X enclosure that interfaces with up to two snow and ice sensors (any combination of Snow Owl, GIT-1, or SIT-6E), sold separately. The controller has an adjustable Hold-On timer that continues heater operation up to 8 hours after the sensors stop detecting snow or ice ensure snow and ice is completely melted. The Heater Cycle toggle switch allows for manual activation or cancellation of heater operation. Controller is c-UL-us Listed and is available for 120-277 V single-phase supply with 24-Amp relay.

Enclosure dimensions: 5 1/2 in x 8 1/8 in x 4 3/8 in (140 mm x 206 mm x 111 mm)

Snow melting and gutter de-icing sensors and accessories



Snow Owl

Overhead snow sensor that detects precipitation or blowing snow at ambient temperatures below 38°F (3.3°C). For use with a PD-Pro, GF-Pro, APS-3C or APS-4C automatic snow controller, or an SC-40C satellite contactor.

5

Control, Monitoring and Power Distribution

TABLE 7: CONTROL SYSTEMS



GIT-1

Gutter sensor that detects moisture at ambient temperatures below 38°F (3.3°C). For use with a PD-Pro, GF-Pro, APS-3C or APS-4C automatic snow controller, or a SC-40C satellite contactor.

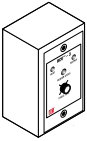

RCU-3

The RCU-3 provides control and status display to the APS-3C controller from a remote location. It has a 2, 4, 6 or 8 hour CYCLE TIME adjustment, independent of APS-3C setting.

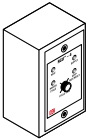

RCU-4

The RCU-4 provides control and status display to the APS-4C controller and SC-40C Satellite Contactor from a remote location. It has a 2, 4, 6 or 8 hour CYCLE TIME adjustment, independent of the APS-4C or SC-40C setting.

Automatic Moisture/Temperature Controller

The most conservative approach from an energy-consumption point of view is an automatic moisture/temperature controller. nVent supplies an automatic moisture/temperature sensor, which consists of an APS control panel, one or more GIT-1 gutter sensors, and one or more nVent RAYCHEM Snow Owl aerial snow sensors. The Roof and Gutter De-Icing: IceStop System Design Guide (H56070) outlines the options for this approach.

The GIT-1 ice sensor should be mounted in gutters near downspouts. It senses the actual environmental conditions, such as temperature and moisture. A GIT-1 sensor is recommended for each critical area that needs to be monitored for icing conditions (such as when one side of a building gets sun in the morning and the other side gets sun in the afternoon, or one side gets the prevailing winds and the other side is protected). A Snow Owl aerial-mounted snow sensor is also recommended. Having both gutter and snow sensors allows for snow to begin melting in the gutters at the onset of any snow or ice condition.

5

Control, Monitoring and Power Distribution

5.2 Power Distribution

Once the heating cable circuits and control have been defined, you must select how to provide power to them. Power to the IceStop heating cables can be provided in several ways: directly through the controller, through external contactors, or through SMPG or HTPG power distribution panels.

 **WARNING:** To minimize the danger of fire from sustained electrical arcing if the heating cable is damaged or improperly installed, and to comply with the requirements of nVent, agency certifications, and national electrical codes, ground-fault equipment protection must be used on each heating cable branch circuit. Arcing may not be stopped by conventional circuit protection.

 **WARNING:** Heating cable must only be used for de-icing. Heating cable must not be installed inside buildings. All heating cable to junction box or power connections must be made external to buildings. Appropriately-sized power source wiring and proper power connection accessories may be required for power connection from power source to service area to minimize the danger of fire.

Single Circuit Control

Heating cable circuits that do not exceed the current rating of the selected control device shown in Table 8 can be switched directly.

Group Control

If the current draw exceeds the switch rating, or if the controller will activate more than one circuit (group control), an external contactor must be used.

5

Control, Monitoring and Power Distribution

Typical Wiring Schematics

Single circuit control

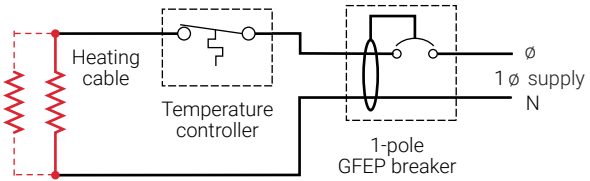

Group control

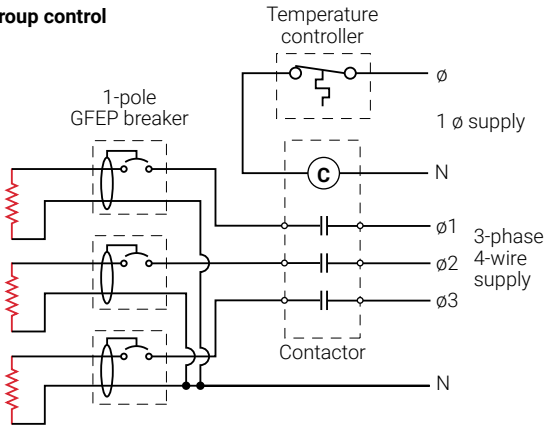

Figure 26: Typical controller wiring—multiple circuits

5

Control, Monitoring and Power Distribution

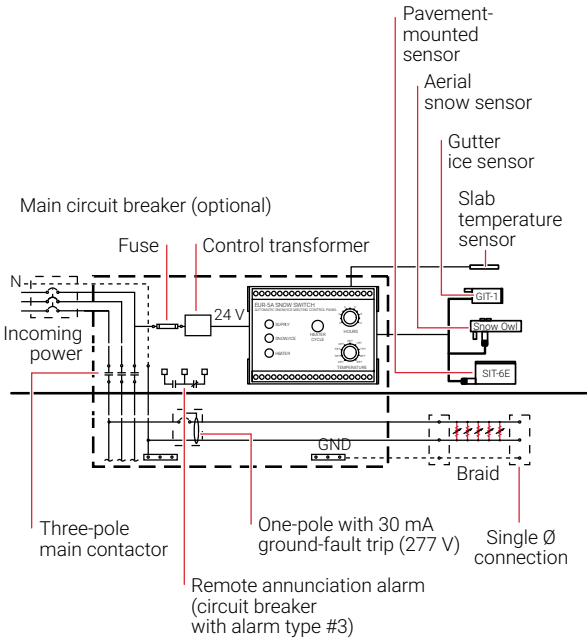

Figure 27: Typical wiring diagram of group control with SMPG1

Control and Feed Wiring

The controls and feed wiring must be in place prior to system startup.

- Use a 30 mA trip level ground-fault equipment protection device for each circuit.
- Power the system with the appropriate voltage.
- Add conduit drains at power connection so water does not accumulate in junction boxes.
- Be sure the contactor being used is appropriate for the load. If the controller is being used directly, be sure that it is rated for the load and that all requirements for disconnects are followed.
- Test control for proper operation (see "Tests" on page 53).

5

Control, Monitoring and Power Distribution

TABLE 8: MAXIMUM CIRCUIT LENGTH IN FEET (METERS)

15 A and 20 A

Heating cable	Start-up temperature	Circuit breaker size		Max. A/ft	Max. A/m
		15 A	20 A		
GM-1X & GM-1XT at 120 V	32°F (0°C)	100 (30)	135 (41)	0.120	0.394
	20°F (-7°C)	95 (29)	125 (38)	0.126	0.414
	0°F (-18°C)	80 (24)	100 (30)	0.150	0.492
GM-2X & GM-2XT at 208 V	32°F (0°C)	190 (58)	250 (76)	0.063	0.207
	20°F (-7°C)	180 (55)	235 (72)	0.067	0.220
	0°F (-18°C)	145 (44)	195 (59)	0.083	0.272
GM-2X & GM-2XT at 240 V	32°F (0°C)	200 (61)	265 (81)	0.060	0.197
	20°F (-7°C)	190 (58)	250 (76)	0.063	0.207
	0°F (-18°C)	155 (47)	205 (62)	0.077	0.253
GM-2X & GM-2XT at 277 V	32°F (0°C)	215 (66)	290 (88)	0.056	0.184
	20°F (-7°C)	200 (61)	265 (81)	0.060	0.197
	0°F (-18°C)	165 (50)	225 (69)	0.073	0.240

30 A and 40 A

Heating cable	Start-up temperature	Circuit breaker size		Max. A/ft	Max. A/m
		30 A	40 A1		
GM-1X & GM-1XT at 120 V	32°F (0°C)	200 (61)	—	0.120	0.394
	20°F (-7°C)	185 (56)	200 (61)	0.126	0.414
	0°F (-18°C)	155 (47)	200 (61)	0.150	0.492
GM-2X & GM-2XT at 208 V	32°F (0°C)	380 (116)	—	0.063	0.207
	20°F (-7°C)	355 (108)	380 (116)	0.067	0.220
	0°F (-18°C)	290 (88)	380 (116)	0.083	0.272
GM-2X & GM-2XT at 240 V	32°F (0°C)	400 (122)	—	0.060	0.197
	20°F (-7°C)	370 (113)	400 (122)	0.063	0.207
	0°F (-18°C)	305 (93)	400 (122)	0.077	0.253
GM-2X & GM-2XT at 277 V	32°F (0°C)	415 (126)	—	0.056	0.184
	20°F (-7°C)	400 (122)	415 (126)	0.060	0.197
	0°F (-18°C)	330 (101)	415 (126)	0.073	0.240

1 Only FTC-P power connection, FTC-HST-PLUS splice/tee, and RayClc-E end kits may be used with 40-amp circuits.

6

Commissioning and Preventive Maintenance

6.1 System Start-up and Operation

Once the system has been installed and tested, it is ready to be powered. A manually-controlled system will have to be turned on at each snow storm and turned off when the roof is cleared of all snow. Thermostatically-controlled systems and dual-sensing systems will turn on and off automatically.

Prior to System Start-Up

- Perform a final visual inspection of all circuits.
- Perform a final insulation resistance test of all circuits.
- Instruct owner/user on system operation and maintenance.
- Be sure that owner/user has all applicable installation instructions and operation manuals.

Indication of Operation

Some possible indicators of a properly operating system are the following:

- The controller may indicate the circuit is powered.
- Visible paths may show through the snow around the heating cable.
- Cable may feel warm to the touch.
- Water drainage may be visible at the gutter or downspout.

6.2 Insulation Resistance (Megohmmeter) Test

The insulation resistance test is critical to ensure the safety and reliability of the heating cable system. This test should be performed as part of the installation of the system, and is useful for troubleshooting an installed system.



WARNING: Shock or Fire Hazard. Disconnect power to all circuits prior to testing.

6

Commissioning and Preventive Maintenance

⚠ WARNING: The heating cable can store a large electrical charge after the insulation resistance test is performed. To prevent personal injury from electrical shock, fully discharge the cable prior to disconnecting the megohmmeter. The megohmmeter may discharge automatically. However, it may be necessary to short the cable leads. Contact your supervisor or the instrument manufacturer to verify the safest practice.

Using a megohmmeter, test insulation resistance at three voltages—500, 1000, and 2500 Vdc. Significant problems may not be detected if the insulation resistance is tested only at 500 or 1000 volts. First, measure the resistance between the heating cable bus wires and the grounding braid; then, if the heating cable is installed on a metal gutter, downspout, and/or metal roof, measure the insulation resistance between the braid and the metal surface.

Procedure

1. Disconnect all power to the heating cable, thermostat, and contactor.
2. Set test voltage at 0 Vdc.
3. Connect the negative lead (-) to the heating cable metallic braid.
4. Connect the positive lead (+) to both heating cable bus wires.

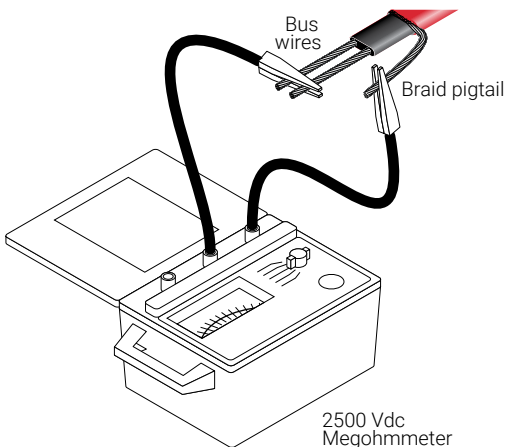

6

Commissioning and Preventive Maintenance

5. Turn on the megohmmeter and set the voltage to 500 Vdc; apply the voltage for 1 minute. Record the resistance.
6. Repeat step 5 at 1000 Vdc and 2500 Vdc.
7. Turn off the megohmmeter.
8. If the megohmmeter does not self-discharge, discharge phase connection to ground with a suitable grounding rod. Disconnect the megohmmeter.
9. If the heating cable is installed on a metal roof, metal gutter, or metal downspout, repeat these steps with the negative lead (-) connected to the grounding braid and the positive lead (+) connected to the metal roof, gutter, and/or downspout.
10. Reconnect the thermostat or contactor and re-energize the circuit.

Insulation Resistance Criteria

A clean, dry, properly installed circuit should measure hundreds of megohms, regardless of the heating cable length or measuring voltage (0–2500 Vdc). The following criteria are provided to assist in determining the acceptability of an installation where optimum conditions may not apply:

- All three insulation resistance values should be greater than 1000 megohms.
- Insulation resistance values for any particular circuit should not vary more than 25 percent as a function of measuring voltage.
- Reading must be steady at measuring voltage.
- If any of the above conditions are not met, consult “Troubleshooting,” Section 8.

6

Commissioning and Preventive Maintenance

6.3 Continuity Test

The continuity test is useful in determining if the heating cable is damaged or was not connected correctly. This test can be performed as part of the troubleshooting procedure.



Important: Some of the heating cable connection kits, such as the end seal kit and power connection, splice, and tee kits, which utilize heat-shrink tubings, are not reenterable and must be replaced after this test is done.



WARNING: Shock or Fire Hazard. Disconnect power to all circuits prior to testing.

1. Disconnect all power to heating cable, thermostat, and contactor.
2. Twist the two bus wires together at one end.
3. Take a resistance reading from bus wire to bus wire at the other end. The reading should be 3 ohms or less. High readings (above 1000 ohms) generally indicate bus wire damage or improperly installed connection kits.
4. If there are any tees on the circuit, each leg of the tee must be tested separately.
5. Be sure to untwist the bus wires and install new connection kits on the circuit prior to re-energizing the circuit.
6. Reconnect the contactor or thermostat and re-energize the circuit.

7

Test Procedures

nVent requires a series of commissioning tests be performed on the IceStop system. These tests are also recommended at regular intervals for preventive maintenance. Results must be recorded and maintained for the life of the system, utilizing the “Installation and Inspection Record” (refer to Section 9). Submit this manual with initial commissioning test results to the owner.

7.1 Tests

A brief description of each test is found below. Detailed test procedures are found in Section 7.

Visual Inspection

Visually inspect the pipe, insulation, and connections to the heating cable for physical damage. Check that no moisture is present, electrical connections are tight and grounded, insulation is dry and sealed, and control and monitoring systems are operational and properly set. Damaged heating cable must be replaced.

Insulation Resistance

Insulation Resistance (IR) testing is used to verify the integrity of the heating cable inner and outer jackets. IR testing is analogous to pressure testing a pipe and detects if a hole exists in the jacket.

Ground-Fault Test

Test all ground-fault breakers per manufacturer’s instructions.

7

Test Procedures

7.2 Insulation Resistance Test – Test 1

Insulation resistance is measured between the heating cable sheath and the tails. nVent recommends that insulation resistance testing (using a megohmmeter) be conducted at 2500 Vdc.

Frequency

Insulation resistance testing is recommended at four stages during the installation process and as part of regularly scheduled maintenance.

- When received
 - After the cables have been installed
 - Prior to initial start-up (commissioning)
 - As part of the regular system inspection
 - After any maintenance or repair work
- * Under adverse weather conditions, or when the tails or terminal connections have evidence of moisture, lower insulation resistances may be encountered. Wipe tails, face of pot, and all terminal connections with a clean dry rag to eliminate moisture and retest.

Test Criteria

The minimum insulation resistance for a clean, dry, properly installed circuit should reflect the values shown above, regardless of the heating cable length.

7

Test Procedures

7.3 Insulation Resistance (Megohmmeter) Test

The insulation resistance test is critical to ensure the safety and reliability of the heating cable system. This test should be performed as part of the installation of the system, and is useful for troubleshooting an installed system.

 **WARNING: Shock or Fire Hazard. Disconnect power to all circuits prior to testing.**

Using a megohmmeter, test insulation resistance at three voltages—500, 1000, and 2500 Vdc.

Significant problems may not be detected if the insulation resistance is tested only at 500 or 1000 volts. First, measure the resistance between the heating cable bus wires and the grounding braid; then, if the heating cable is installed on a metal gutter, downspout, and/or metal roof, measure the insulation resistance between the braid and the metal surface.

7

Test Procedures

Procedure

1. Disconnect all power to the heating cable, thermostat, and contactor.
2. Set test voltage at 0 Vdc.
3. Connect the negative lead (-) to the heating cable metallic braid.
4. Connect the positive lead (+) to both heating cable bus wires.
5. Turn on the megohmmeter and set the voltage to 500 Vdc; apply the voltage for 1 minute. Record the resistance.
6. Repeat step 5 at 1000 Vdc and 2500 Vdc.
7. Turn off the megohmmeter.
8. If the megohmmeter does not self-discharge, discharge phase connection to ground with a suitable grounding rod. Disconnect the megohmmeter.
9. If the heating cable is installed on a metal roof, metal gutter, or metal downspout, repeat these steps with the negative lead (-) connected to the grounding braid and the positive lead (+) connected to the metal roof, gutter, and/or downspout.
10. Reconnect the thermostat or contactor and re-energize the circuit.

Insulation Resistance Criteria

A clean, dry, properly installed circuit should measure thousands of megohms, regardless of the heating cable length or measuring voltage (0–2500 Vdc). The following criteria are provided to assist in determining the acceptability of an installation where optimum conditions may not apply:

- All three insulation resistance values should be greater than 100 megohms.
- Insulation resistance values for any particular circuit should not vary more than 25 percent as a function of measuring voltage.
- Reading must be steady at measuring voltage.

7

Test Procedures

- If any of the above conditions are not met, consult the “Troubleshooting” instructions in Section 8.

Continuity Test

The continuity test is useful in determining if the heating cable is damaged or was not connected correctly. This test can be performed as part of the troubleshooting procedure. **Note:** Some of the heating cable connection kits, such as the end seal kit and power connection, splice, and tee kits, which utilize heat-shrink tubings, are not reusable and will have to be replaced after this test is done.



WARNING: Shock or Fire Hazard. Disconnect power to all circuits prior to testing.

1. Disconnect all power to heating cable, thermostat, and contactor.
2. Twist the two bus wires together at one end.
3. Take a resistance reading from bus wire to bus wire at the other end. The reading should be 3 ohms or less. High readings (above 1000 ohms) generally indicate bus wire damage or improperly installed connection kits.
4. If there are any tees on the circuit, each leg of the tee must be tested separately.
5. Be sure to untwist the bus wires and install new connection kits on the circuit prior to re-energizing the circuit.
6. Reconnect the contactor or thermostat and re-energize the circuit.

7

Test Procedures

7.4 Fault Location Tests

There are three methods used for finding a fault within a section of heating cable.

1. Ratio method
2. Conductance method
3. Capacitance method

Ratio Method

The ratio method uses resistance measurements taken at each end of the heating cable to approximate the location of a bus wire short. A shorted heating cable could result in a tripped circuit breaker. If the resistance can be read on a standard ohm meter this method can also be used to find a fault from a bus wire to the ground braid. This type of short would trip a GFPD and show a failed insulation resistance reading. Measure the bus-to-bus heating cable resistance at each end (measurement A and measurement B) of the suspected section.

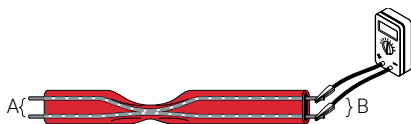

Figure 28: Cable resistance measurement test

The approximate location of the fault, expressed as a percentage of the heating cable length from the front end, is:

$$\text{Fault location: } D = \frac{A}{(A + B)} \times 100$$

Example: A = 1.2 ohms
 B = 1.8 ohms

$$\begin{aligned} \text{Fault location: } D &= 1.2 / (1.2 + 1.8) \times 100 \\ &= 40\% \end{aligned}$$

To locate a low resistance ground fault, measure between bus and braid.

7

Test Procedures

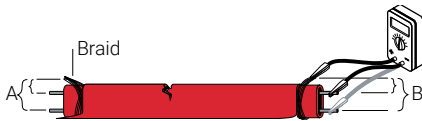

Figure 29: Low resistance ground-fault test

The approximate location of the fault, expressed as a percentage of the heating cable length from the front end, is:

$$\text{Fault location: } D = \frac{A}{(A + B)} \times 100$$

Example: A = 1.2 ohms
 B = 1.8 ohms

$$\begin{aligned} \text{Fault location: } D &= 1.2 / (1.2 + 1.8) \times 100 \\ &= 40\% \end{aligned}$$

The fault is located 40% into the circuit as measured from the front end.

7

Test Procedures

Conductance Method

The conductance method uses the core resistance of the heating cable to approximate the location of a fault when the heating cable has been severed and the bus wires have not been shorted together. A severed cable may result in a cold section of pipe and may not trip the circuit breaker. Measure the bus-to-bus heating cable resistance at each end (measurement A and measurement B) of the suspect section. Since self-regulating cables are a parallel resistance, the ratio calculations must be made using the conductance of the cable.



Figure 30: Cable resistance measurement

The approximate location of the fault, expressed as a percentage of the heating cable length from the front end, is:

$$\text{Fault location: } D = \frac{1/A}{(1/A + 1/B)} \times 100$$

Example: A = 100 ohms
 B = 25 ohms

$$\text{Fault location: } D = (1/100) / (1/100 + 1/25) \times 100 \\ = 20\%$$

The fault is located 20% from the front end of the circuit.

7

Test Procedures

Capacitance Method

This method uses capacitance measurement (nF) to approximate the location of a fault where the heating cable has been severed or a connection kit has not been connected.

Record the capacitance reading from one end of the heating cable. The capacitance reading should be measured between both bus wires twisted together (positive lead) and the braid (negative lead). Multiply the measured capacitance with the heating cable's capacitance factor as listed in the following example:

Example: Capacitance measurement = 42.2 nF

Capacitance factor = 6.0 ft/nF for all IceStop cables

Fault location = 42.2 nF x 6.0 ft/nF
= 253 ft (77 m)

The ratio of one capacitance value taken from one end (A) divided by the sum of both A and B (A + B) and then multiplied by 100 yields the distance from the first end, expressed as a percentage of the total heating cable circuit length.

Fault location: $C = \frac{A}{(A + B)} \times 100$

8

Troubleshooting Guide

Symptom

A. Circuit breaker trips.

Circuit breaker undersized.

Circuit length too long.

Start-up temperature below design temperature.

Defective circuit breaker.

Connections or splices may be shorting out. Physical damage to the heating cable.

Bus wires in contact with each other.

Excessive moisture in connection boxes or splices.

Nick or cut in heating cable or power feed wire with moisture present.

Using 5 mA ground-fault interruptor instead of 30 mA ground-fault protection device.

8

Troubleshooting Guide

Corrective Action

Resize the circuit breakers and feed wiring per **Roof and Gutter De-Icing: IceStop System Design Guide** (H56070).

Replace circuit breaker.

To confirm that heating cable is damaged, test the insulation resistance according to the procedures described in "Test Methods."

Locate and repair incorrect connections or splices.

Locates and remove damaged sections of heating cable.

To locate shorting problems, follow these steps:

1. Visually inspect the power connection, splices, and end seals for proper installation.
 2. Check for visual indications of damage to the cable, especially in any area where there may have been maintenance work.
 3. Look for damage at entrances to downspouts, around eaves, and at transitions from roof and gutter.
 4. If at this point you have not located the problem, you will need to begin isolating sections of the heating cable to find the general area of damage. (For example, cut the circuit in half and, using a megohmmeter, test both halves to find the damaged section.) Then remove the damaged section of heating cable.
-

Cut off the end seal. Re-cut the cable end and install a new end seal.

Dry out and reseal connections and splices. Test with a megohmmeter per installation instructions.

Locate and replace damaged power feed wire.

Replace circuit breaker with 30 mA ground-fault protection device. See GFEPD Selection Guide (H55476) for information on different breakers.

8

Troubleshooting Guide

Symptom

B. Power output is zero or appears low.

Low or no input voltage.

Circuit is shorter than design shows because splices or tees are not connected, or the heating cable has been severed.

Improper connection causes a high-resistance connection.

The control thermostat is wired incorrectly.

C. Heating cable fails insulation resistance test.

Connections or splices may be shorting out. Physical damage to the heating cable.

Excessive moisture in connection boxes or splices.

Nick or cut in heating cable or power feed wire with moisture present.

8

Troubleshooting Guide

Corrective Action

Check voltage and correct.

Check length of cable installed. Check all splices and tees. Check at end seals for continuity as indicated in "Test Methods", Section 7.

Check and fix splices and tees.

Check and rewire controller.

To confirm that heating cable is damaged or connection kits are shorting, test the insulation resistance according to the procedure described in "Test Methods", Section 7.

Locate and repair incorrect connections or splices.

Locate and remove damaged sections of heating cable.

To locate shorting problems, follow these steps:

1. Visually inspect the power connection, splices, and end seals for proper installation.
 2. Check for visual indications of damage to the cable, especially in any area where there may have been maintenance work.
 3. Look for damage at entrances to downspouts, around eaves, and at transitions from roof and gutter.
 4. If at this point you have not located the problem, you will need to begin isolating sections of the heating cable to find the general area of damage. (For example, cut the circuit in half and, using a megohmmeter, test both halves to find the damaged section.) Then remove the damaged section of heating cable.
-

Dry out and reseal connections and splices. Test with a megohmmeter per installation instructions.

Locate and replace damaged heating cable or power feed wire.

8

Troubleshooting Guide

Symptom

D. Heating cable fails insulation resistance test.	Connections or splices may be shorting out. Physical damage to the heating cable.
	Excessive moisture in connection boxes or splices.
	Nick or cut in heating cable or power feed wire with moisture present.
E. Snow is not melting around the heating cable.	Circuit breaker is tripped. Controller not on or not working. Ambient temperature too cold.
F. Downspouts are blocked by ice.	Circuit breaker is tripped. Controller not on or not working. Ambient temperature too cold.
G. The circuit does not draw sufficient power of approximately 12 W/ft (39.36 W/m) at 32°F (0°C) in snow or ice (5 W/ft (16.4 W/m) at 32°F (0°C) in air).	Circuit breaker is tripped. Controller not on or not working. All sections not connected.

8

Troubleshooting Guide

Corrective Action

To confirm that heating cable is damaged or connection kits are shorting, test the insulation resistance according to the procedure described in "Test Methods", Section 7.

Locate and repair incorrect connections or splices.

Locate and remove damaged sections of heating cable.

To locate shorting problems, follow these steps:

1. Visually inspect the power connection, splices, and end seals for proper installation.
 2. Check for visual indications of damage to the cable, especially in any area where there may have been maintenance work.
 3. Look for damage at entrances to downspouts, around eaves, and at transitions from roof and gutter.
 4. If at this point you have not located the problem, you will need to begin isolating sections of the heating cable to find the general area of damage. (For example, cut the circuit in half and, using a megohmmeter, test both halves to find the damaged section.)
Then remove the damaged section of heating cable.
-

Dry out and reseal connections and splices. Test with a megohmmeter per installation instructions.

Locate and replace damaged heating cable or power feed wire.

See Symptom A, "Circuit breaker trips."

Check controller.

See Symptom A, "Circuit breaker trips."

Check controller.

See Symptom A, "Circuit breaker trips."

Check controller.

Repeat continuity test, as detailed in "Continuity Test", "Insulation Resistance (Megohmmeter) Test" on page 55.

9

Installation and Inspection Records

Roof and Gutter De-Icing System Installation Record

INSTALLATION LOCATION

Project name: _____

Reference drawing: _____

Company: _____

Address _____

State/Province: _____

Residential installation environment:

Commercial Industrial Hazardous Area

If installed in a hazardous area, fill in the following additional information:

Area: Ignition temperature _____ °F °C

Group classification _____

INSTALLED BY

Company: _____

Address _____

State/Province: _____

Name _____

VISUAL INSPECTION (check for all heating cables)

The heating cable does not lay unprotected over sharp edges. Yes

Heating cable attachment points are secure. Yes

9

Installation and Inspection Records

Installation date _____

Roof length of installation _____ ft m

City _____

Postal code _____

City _____

Postal Code _____

Phone _____

9

Installation and Inspection Records

ELECTRICAL TESTING

Note: Insulation resistance values should be greater than 1000 megohms.

Perform insulation resistance test at 500, 1000, and 2500 Vdc (bypass controller if applicable)

Megohmmeter manufacturer/model _____

Multimeter manufacturer/model _____

1 Receipt of Material

	Heating cable catalog no./tag no	Insulation resistance (M Ω)	Continuity (Ω)
Cable #1	_____	_____	_____
Cable #2	_____	_____	_____
Cable #3	_____	_____	_____
Cable #4	_____	_____	_____
Cable #5	_____	_____	_____
Cable #6	_____	_____	_____
Cable #7	_____	_____	_____
Cable #8	_____	_____	_____
Cable #9	_____	_____	_____
Cable #10	_____	_____	_____
Cable #11	_____	_____	_____
Cable #12	_____	_____	_____

3 Initial Start-up (Commissioning)



WARNING: Disconnect all power before performing insulation resistance and continuity tests.

	Heating cable catalog no./tag no	Heating cable location	Breaker number
Cable #1	_____	_____	_____
Cable #2	_____	_____	_____
Cable #3	_____	_____	_____
Cable #4	_____	_____	_____
Cable #5	_____	_____	_____
Cable #6	_____	_____	_____
Cable #7	_____	_____	_____
Cable #8	_____	_____	_____
Cable #9	_____	_____	_____
Cable #10	_____	_____	_____
Cable #11	_____	_____	_____
Cable #12	_____	_____	_____

Ground-fault protection (type) _____

Test ground fault _____

Test controller _____

Contractor's signature: _____

Accepted by: _____

Date: _____

9

Installation and Inspection Records

Megohmmeter date of last calibration _____

Ohm setting _____

2 After cable installation

	Heating cable catalog no. /tag no	Insulation resistance (MΩ)
Cable #1	_____	_____
Cable #2	_____	_____
Cable #3	_____	_____
Cable #4	_____	_____
Cable #5	_____	_____
Cable #6	_____	_____
Cable #7	_____	_____
Cable #8	_____	_____
Cable #9	_____	_____
Cable #10	_____	_____
Cable #11	_____	_____
Cable #12	_____	_____

Insulation resistance (MΩ)	Supply voltage (V)	Current (A)
_____	_____	_____
_____	_____	_____
_____	_____	_____
_____	_____	_____
_____	_____	_____
_____	_____	_____
_____	_____	_____
_____	_____	_____
_____	_____	_____
_____	_____	_____
_____	_____	_____

Ground-fault trip setting _____ mA

Witnessed by: _____

Approved by: _____

9

Installation and Inspection Records

Maintenance Log Record

Area location: _____

CIRCUIT INFORMATION

Breaker panel number: _____

VISUAL

Heating system connection kits

Enclosures, junction boxes, contactors sealed _____

Presence of moisture _____

Signs of corrosion _____

Damage to termination _____

ELECTRICAL TESTING

Perform insulation resistance test at 500, 1000, and 2500 Vdc
(bypass controller if applicable)



WARNING: Disconnect all power before performing insulation resistance and continuity tests.

	Heating cable catalog no./tag no	Heating cable location	Breaker number
Cable #1	_____	_____	_____
Cable #2	_____	_____	_____
Cable #3	_____	_____	_____
Cable #4	_____	_____	_____
Cable #5	_____	_____	_____
Cable #6	_____	_____	_____
Cable #7	_____	_____	_____
Cable #8	_____	_____	_____
Cable #9	_____	_____	_____
Cable #10	_____	_____	_____
Cable #11	_____	_____	_____
Cable #12	_____	_____	_____

Ground-fault protection (type) _____

Test ground fault _____

Test controller _____

Comments and actions _____

Prepared by: _____

Approved by: _____

9

Installation and Inspection Records

System _____ Reference drawing(s) _____

Supply voltage _____ Phase _____

Controller and sensor

Signs of corrosion/damage _____

Delay timer set _____

500 Vdc

1000 Vdc

2500 Vdc

_____	_____	_____
_____	_____	_____
_____	_____	_____
_____	_____	_____
_____	_____	_____
_____	_____	_____
_____	_____	_____
_____	_____	_____
_____	_____	_____
_____	_____	_____
_____	_____	_____
_____	_____	_____

Ground-fault trip setting _____ mA

Company _____

Date _____

Company _____

Date _____

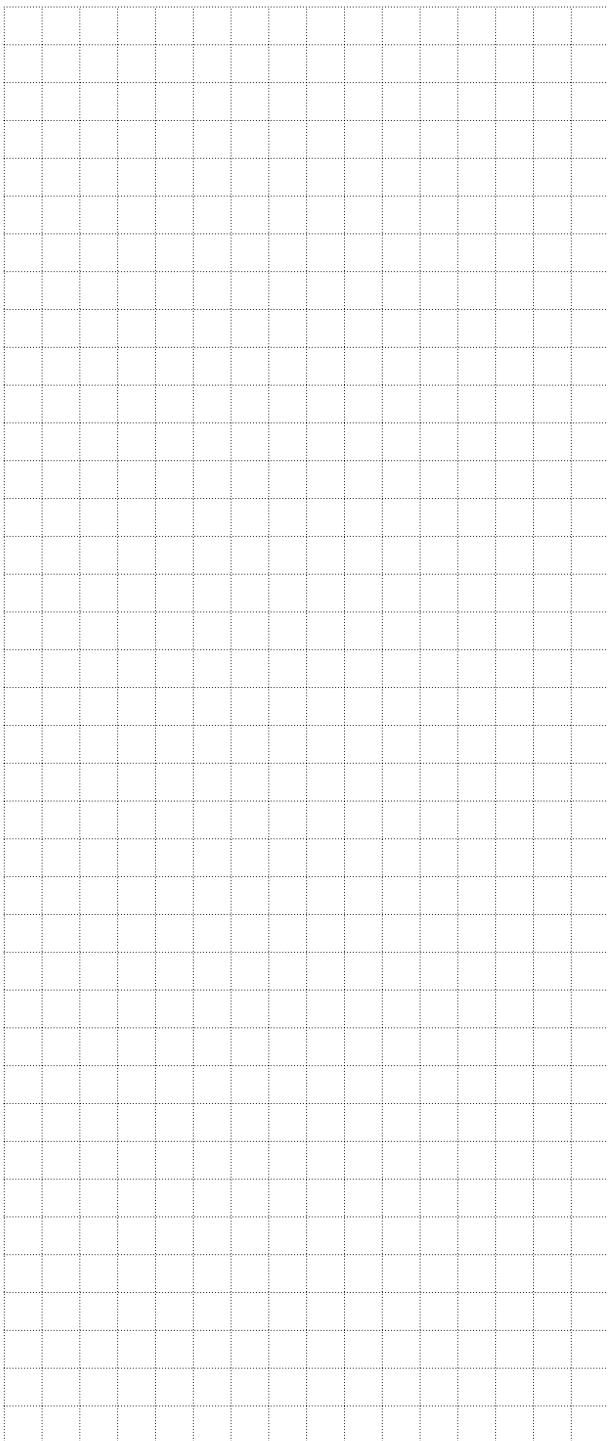

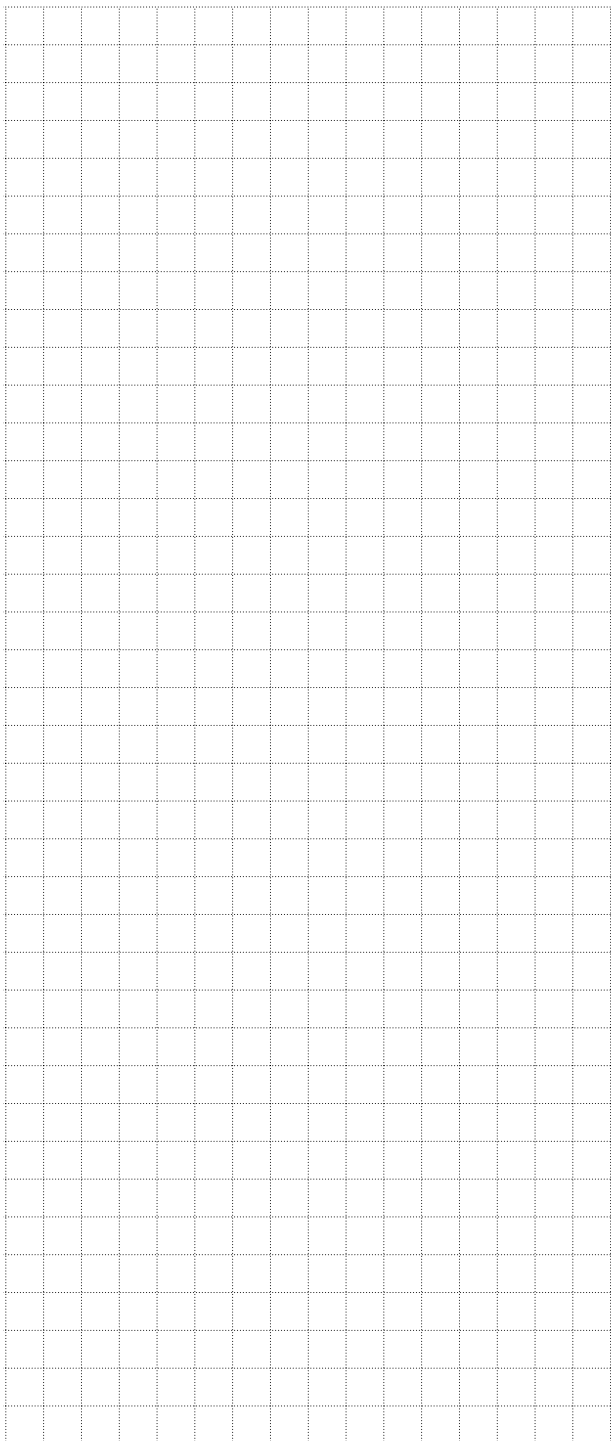

North America

Tel +1.800.545.6258

Fax +1.800.527.5703

thermal.info@nvent.com



nVent.com/RAYCHEM

©2021 nVent. All nVent marks and logos are owned or licensed by nVent Services GmbH or its affiliates. All other trademarks are the property of their respective owners. nVent reserves the right to change specifications without notice.

RAYCHEM-IM-H58067-IceStopRGDI-EN-2106