

CSBSTU

Standard Universal Sway Brace or Restraint Device Sway Brace Fitting

*Part Number	Pipe Size	
	NPS (in)	mm
CSBSTU0100(XX)	1	25
CSBSTU0125(XX)	1-1/4	32
CSBSTU0150(XX)	1-1/2	40
CSBSTU0200(XX)	2	50
CSBSTU0250(XX)	2-1/2	65
CSBSTU0300(XX)	3	80
CSBSTU0400(XX)	4	100
CSBSTU0500(XX)	5	125
CSBSTU0600(XX)	6	150
CSBSTU0800(XX)	8	200
CSBSTU1000(XX)	10	250

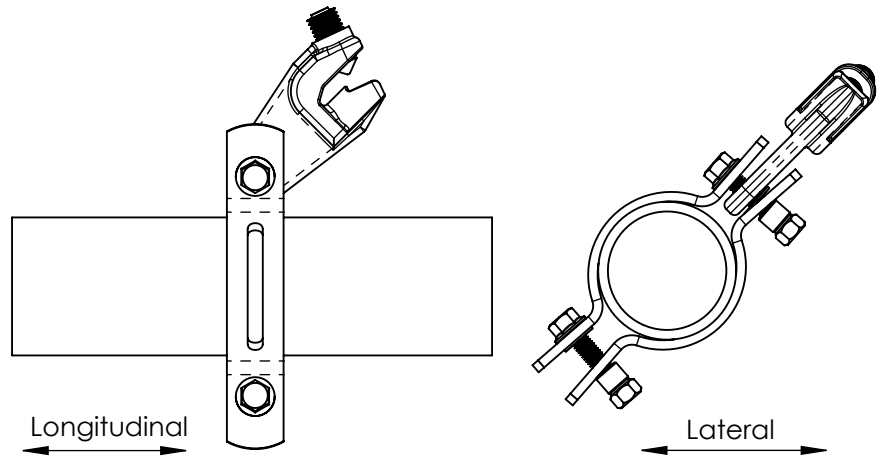

All Brace and Service Pipes shown, Not Included

*(XX) = Finish Specifier

Sway Brace assemblies are intended to be installed in accordance with NFPA-13 and the manufacturer's installation instructions.

The required type, number, and size of fasteners used for the structure attachment fitting shall be in accordance with NFPA-13.

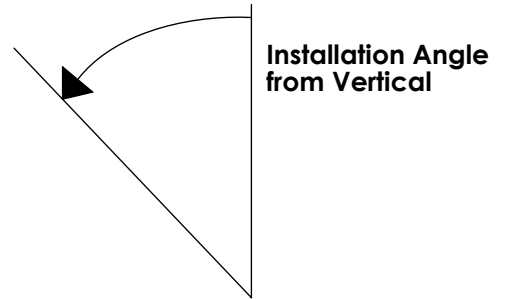

WARNING:

1. nVent products shall be installed and used only as indicated in nVent product instruction sheets and training materials. Instruction sheets are available at www.nVent.com and from your nVent customer service representative.
2. nVent products must never be used for a purpose other than the purpose for which they were designed or in a manner that exceeds specified load ratings.
3. All instructions must be **completely** followed to ensure proper and safe installation and performance.
4. Improper installation, misuse, misapplication or other failure to completely follow nVent's instructions and warnings may cause product malfunction, property damage, serious bodily injury and/or death, and void your warranty.
5. Products that are manufactured using spring steel components shall be used only in a non-corrosive indoor environment.
6. All pipe supports, hangers, intermediate components and structural attachments must **ONLY** be used as described herein and are **NEVER** to be used for any other purpose.

NOTE: All load ratings are for static conditions and do not account for dynamic loading such as wind, water or seismic loads, unless otherwise noted.

The customer is responsible for:

- a. Conformance to all governing codes.
- b. The integrity of structures to which the products are attached, including their capability of safely accepting the loads imposed, as evaluated by a qualified engineer.
- c. Using appropriate industry standard hardware as noted above.

SAFETY INSTRUCTIONS:

All governing codes and regulations and those required by the job site must be observed. Always use appropriate safety equipment such as eye protection, hard hat, and gloves as appropriate to the application.

nVent, nVent CADDY, nVent ERICO Cadweld, nVent ERICO Critec, nVent ERICO, nVent ERIFLEX, and nVent LENTON are owned by nVent or its global affiliates. All other trademarks are the property of their respective owners. nVent reserves the right to change specifications without prior notice.

TECHNICAL SUPPORT:
www.nVent.com

CFS403_P

1 OF 4

© 2008-2021 nVent All Rights Reserved

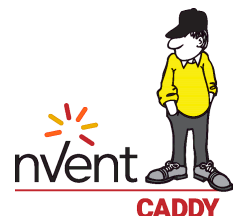

UL Loads (Listed for Restraints) - Lateral and Longitudinal		
Part Number	Sch 10 Service Pipe	Sch 40 Service Pipe
CSBSTU0100(XX)	655 lb (2,914 N)	655 lb (2,914 N)
CSBSTU0125(XX)	655 lb (2,914 N)	655 lb (2,914 N)
CSBSTU0150(XX)	655 lb (2,914 N)	655 lb (2,914 N)
CSBSTU0200(XX)	655 lb (2,914 N)	655 lb (2,914 N)

Notes:

- UL Listed for use with Schedule 10 and Schedule 40 Service Pipe, for use with 1 to 2 NPS Schedule 40 brace pipe or 1/4" angle iron.

UL Loads (Listed for Sway Braces) - Lateral and Longitudinal				
Part Number	Lateral		Longitudinal	
	Sch 10 Service Pipe	Sch 40 Service Pipe	Sch 10 Service Pipe	Sch 40 Service Pipe
CSBSTU0200(XX)	1,200 lb (5,338 N)	1,200 lb (5,338 N)	N/A	N/A
CSBSTU0250(XX)	2,045 lb (9,097 N)	2,045 lb (9,097 N)	1,375 lb (6,116 N)	1,375 lb (6,116 N)
CSBSTU0300(XX)	1,600 lb (7,117 N)	1,600 lb (7,117 N)	700 lb (3,114 N)	700 lb (3,114 N)
CSBSTU0400(XX)	2,045 lb (9,097 N)	2,045 lb (9,097 N)	1,375 lb (6,116 N)	1,375 lb (6,116 N)
CSBSTU0500(XX)	2,045 lb (9,097 N)	2,045 lb (9,097 N)	1,375 lb (6,116 N)	1,375 lb (6,116 N)
CSBSTU0600(XX)	1,100 lb (4,893 N)	1,100 lb (4,893 N)	1,100 lb (4,893 N)	1,100 lb (4,893 N)
CSBSTU0800(XX)	2,045 lb (9,097 N)	2,045 lb (9,097 N)	1,375 lb (6,116 N)	1,375 lb (6,116 N)
CSBSTU1000(XX)	2,045 lb (9,097 N)	2,045 lb (9,097 N)	1,885 lb (8,385 N)	1,885 lb (8,385 N)

Notes:

- UL Listed for use with Schedule 10 and Schedule 40 Service Pipe, for use with 1 to 2 NPS Schedule 40 brace pipe.

UL Loads (Listed for Sway Braces) - Lateral and Longitudinal				
Part Number	Lateral		Longitudinal	
	KS D 3507 Service Pipe	KS D 3562 Service Pipe	KS D 3507 Service Pipe	KS D 3562 Service Pipe
CSBSTU0800(XX)	2,045 lb (9,097 N)	2,045 lb (9,097 N)	1,375 lb (6,116 N)	1,375 lb (6,116 N)
CSBSTU1000(XX)	2,045 lb (9,097 N)	2,045 lb (9,097 N)	1,885 lb (8,385 N)	1,885 lb (8,385 N)

Notes:

- UL Listed for use with KS D 3507 and KS D 3562 Service Pipe, for use with 25A to 32A KS D 3562 brace pipe.

Part Number	Orientation to Sprinkler Pipe	Service Pipe Size		Pipe Schedule	FM Horizontal Load Rating lbs (N)			
					Installation Angle			
		Inch	mm		30° - 44°	45° - 59°	60° - 74°	75° - 90°
CSBSTU0100(XX)	Lateral	1	25	LW, 10, 40	860 (3,825)	1,220 (5,425)	1,500 (6,670)	1,670 (7,430)
CSBSTU0125(XX)		1-1/4	32					
CSBSTU0150(XX)		1-1/2	40					
CSBSTU0200(XX)	Lateral	2	50	LW, 10, 40	1,530 (6,805)	2,160 (9,610)	2,650 (11,790)	2,960 (13,165)
CSBSTU0250(XX)		2-1/2	65					
CSBSTU0300(XX)		3	85					
CSBSTU0400(XX)	Lateral	4	100	LW, 10, 40	1,570 (6,985)	2,220 (9,875)	2,720 (12,100)	3,030 (13,480)
CSBSTU0500(XX)		5	125					
CSBSTU0600(XX)	Lateral	6	150	LW, 10, 40	1,980 (8,805)	2,810 (12,500)	3,440 (15,300)	3,840 (17,080)
CSBSTU0800(XX)	Lateral	8	200	0.188, 40	2,040 (9,075)	2,890 (12,855)	3,540 (15,745)	3,950 (17,570)
CSBSTU1000(XX)		10	250					
CSBSTU0100(XX)	Longitudinal	1	25	LW, 10, 40	970 (4,315)	720 (3,200)	860 (3,825)	960 (4,270)
CSBSTU0125(XX)		1-1/4	32					
CSBSTU0150(XX)		1-1/2	40					
CSBSTU0200(XX)	Longitudinal	2	50	LW, 10, 40	870 (3,870)	690 (3,070)	830 (3,690)	930 (4,136)
CSBSTU0250(XX)		2-1/2	65					
CSBSTU0300(XX)		3	85					
CSBSTU0400(XX)	Longitudinal	4	100	LW, 10, 40	1,550 (6,895)	1,390 (6,185)	1,680 (7,475)	1,870 (8,320)
CSBSTU0500(XX)		5	125					
CSBSTU0600(XX)	Longitudinal	6	150	LW, 10, 40	1,470 (6,540)	1,170 (5,205)	1,410 (6,270)	1,570 (6,985)
CSBSTU0800(XX)	Longitudinal	8	200	0.188, 40	1,200 (5,340)	1,700 (7,560)	2,090 (9,295)	2,330 (10,365)
CSBSTU1000(XX)		10	250					

Notes:

- FM approved when used with 1", 1-1/4" or 2" (DN25, DN32, DN40, DN50) NPS Schedule 40, GB/T 3091, EN 10255 (Heavy), AS 1074 (Heavy) or JIS G3454 brace pipe.
- Load ratings for Schedule 40 above may also be applied to AS 1074 (Heavy), GB/T 3091, EN 10255 (Heavy) and JIS G3454 pipe.
- Load ratings for Schedule 10 above may also be applied to AS 1074 (Medium), GB/T 3091, EN 10255 (Medium or Heavy), JIS G3452, FM approved Thinwall, and Schedule 40 pipes unless otherwise indicated.
- Load ratings for LW above refers to FM Approved Lightwall Pipe, commonly referred to as "Schedule 7". These ratings may also be applied to A1074 Lightwall, EN 10255 L, EN 10220, and GB/T 8163 pipe unless otherwise specified.
- Load ratings for "0.188 wall" above may be applied to any thicker walled pipe unless otherwise specified.

#1

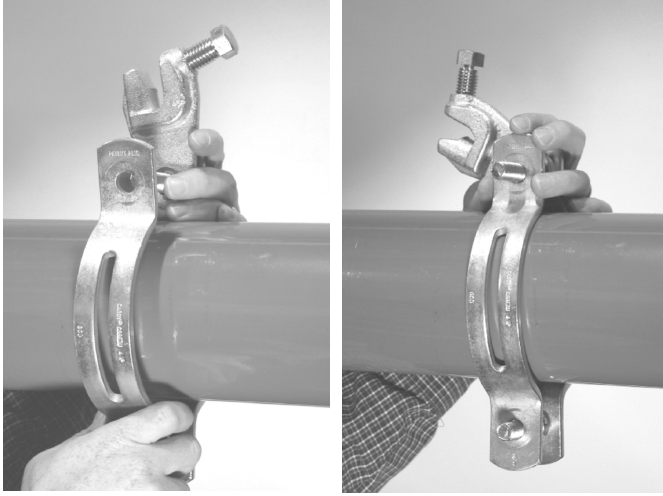

Position stamped components around service pipe

#2

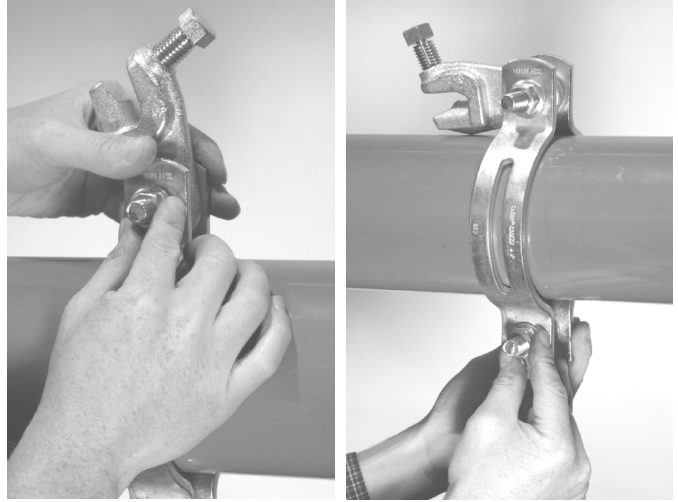

Finger tighten nuts and rotate assembly to desired orientation

#3

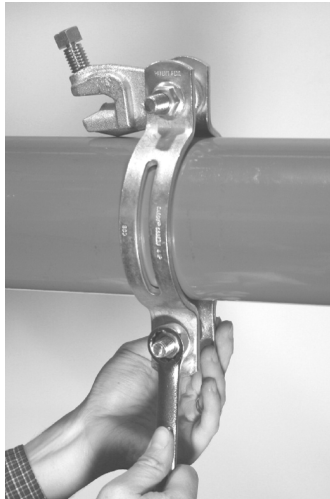

*Part Number	Torque	
	ft-lbs.	N-m
CSBSTU0100(XX)	25	34
CSBSTU0125(XX)		
CSBSTU0150(XX)		
CSBSTU0200(XX)	50	68
CSBSTU0250(XX)		
CSBSTU0300(XX)		
CSBSTU0400(XX)		
CSBSTU0500(XX)	65	88
CSBSTU0600(XX)		
CSBSTU0800(XX)		
CSBSTU1000(XX)		

First tighten bolt that passes through brace clamp until the shear head on nut snaps off. Then proceed to tighten the other bolt on the CSBSTU until the shear head on nut snaps off.

#4

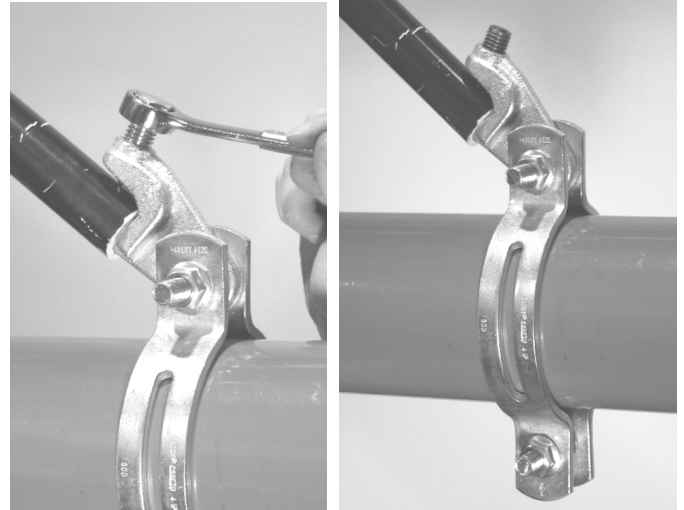

Insert brace into brace clamp as far as possible. Tighten shear head set screw until head snaps off

*(XX) Finish Specifier

All Brace and Service Pipes shown, Not Included

CSBSTU is a Sway Brace Fitting. It is intended to be combined with a nVent CADDY brand Structural Attachment Fitting and "Bracing Pipe" to form a complete bracing assembly.

Sway Braces are intended to be installed in accordance with NFPA-13 and the manufacturer's assembly and instructions.