

# nVent CADDY Speed Link Spools and Spool Kits

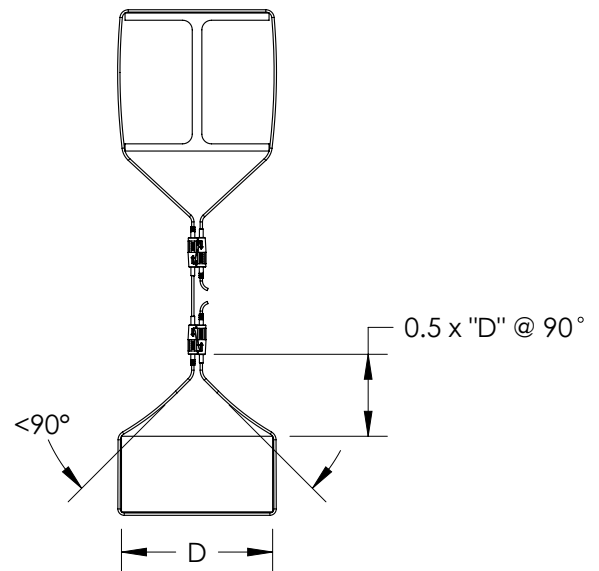
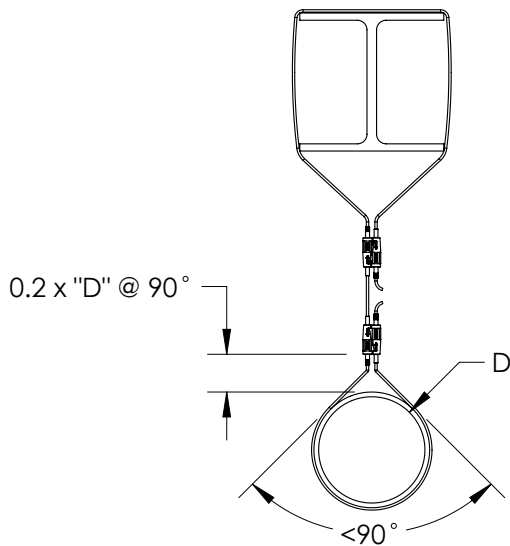
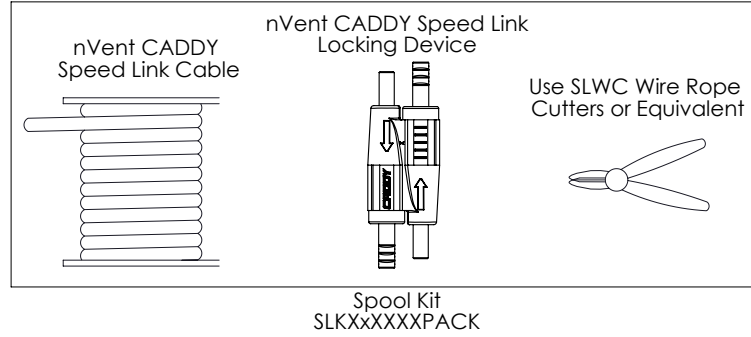
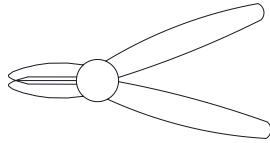
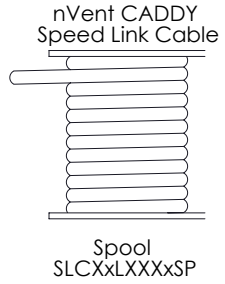
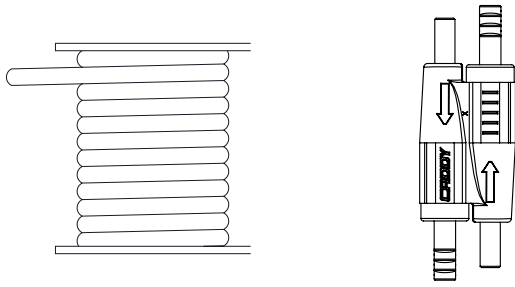

**WARNING:**

1. nVent products shall be installed and used only as indicated in nVent product instruction sheets and training materials. Instruction sheets are available at [www.nVent.com](http://www.nVent.com) and from your nVent customer service representative.
2. nVent products must never be used for a purpose other than the purpose for which they were designed or in a manner that exceeds specified load ratings.
3. All instructions must be **completely** followed to ensure proper and safe installation and performance.
4. Improper installation, misuse, misapplication or other failure to completely follow nVent's instructions and warnings may cause product malfunction, property damage, serious bodily injury and/or death, and void your warranty.
5. Products that are manufactured using spring steel components shall be used only in a non-corrosive indoor environment.
6. All pipe supports, hangers, intermediate components and structural attachments must **ONLY** be used as described herein and are **NEVER** to be used for any other purpose.

NOTE: All load ratings are for static conditions and do not account for dynamic loading such as wind, water or seismic loads, unless otherwise noted.

The customer is responsible for:

- a. Conformance to all governing codes.
- b. The integrity of structures to which the products are attached, including their capability of safely accepting the loads imposed, as evaluated by a qualified engineer.
- c. Using appropriate industry standard hardware as noted above.

**SAFETY INSTRUCTIONS:**

All governing codes and regulations and those required by the job site must be observed. Always use appropriate safety equipment such as eye protection, hard hat, and gloves as appropriate to the application.

nVent, nVent CADDY, nVent ERICO Cadweld, nVent ERICO Critec, nVent ERICO, nVent ERIFLEX, and nVent LENTON are owned by nVent or its global affiliates. All other trademarks are the property of their respective owners. nVent reserves the right to change specifications without prior notice.

TECHNICAL SUPPORT:  
[www.nVent.com](http://www.nVent.com)

CFS583\_A

1 OF 2

© 2018 nVent All Rights Reserved

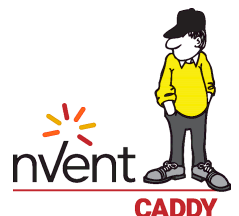

## SLK Standard Application

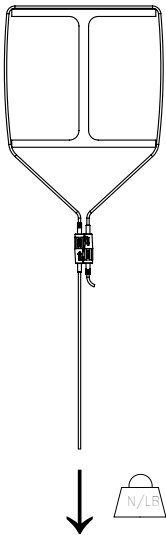

Device	Cable	Working Load	
		N	LB
SLK2	1.5mm	195	44
SLK2	2.0mm	440	100
SLK3	3.0mm	890	200

## SLK Infinite Loop Application

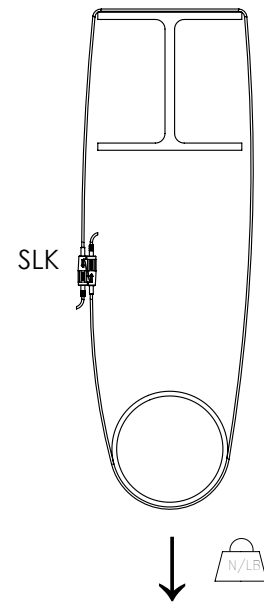

Device	Cable	Working Load	
		N	LB
SLK2	1.5mm	400	90
SLK2	2.0mm	700	160
SLK3	3.0mm	1550	350

## SLS/SLK Combination

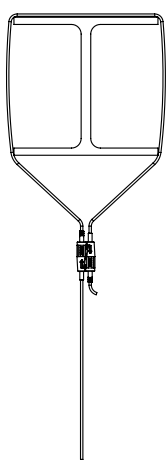

Step 1

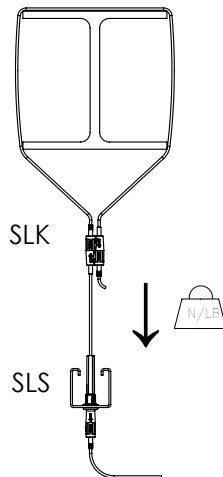

Step 2

Device	Cable	Working Load	
		N	LB
SLS2	1.5mm	180	40
	2.0mm	265	60
SLS3	2.0mm	265	60
	3.0mm	670	150