

CONNECT AND PROTECT

Why Couplers?

nvent

LENTON

Why a Mechanical Splice is Best in Reinforced Concrete

AN APPROACH TO SPLICES

BASIC ASPECTS

The traditional method of connecting reinforcement has been by over lapping two parallel bars.

The overlap load transfer mechanism takes advantage of the "bond" that exists between the steel and the concrete. The load in one bar is transferred to the concrete and then from the concrete to the ongoing bar.

The "bond" is largely influenced by the deformations (transverse ribs) on the surface of the reinforcing bar.

Fig. 1 shows a traditional lap and some means used to reduce the lap length "L" by the use of bent reinforcement. However these means are expensive and cannot be used in all cases.

Fig. 2 shows how the overlap transfer mechanism generates additional forces in the concrete. These forces tend to push the bars apart and the concrete cover must be strong enough to sustain this "bursting" force. Should the bursting force become too large then "spalling" of the concrete cover will occur and the splice fails. Most design codes require additional transverse reinforcement especially for splices of larger sizes of reinforcing bars.

Fig. 3 shows the principle of the load transfer. The steel bars may be either in axial tension or axial compression. The diagram illustrates the distribution of tensile stresses in the concrete normal to the axis of the bars.

As a consequence many parameters must be considered in the design of a correctly engineered overlap splice.

These include:

- **Grade of steel.** The higher the yield stress the greater the lap length required.
- **Surface condition of the bar.** Plain or indented bars need a greater lap length than ribbed bars.
- **Size of bars.** The larger the bar the longer the lap.
- **Grade of concrete.** The lower the concrete strength the longer the lap length required.
- **Position of the splice with respect to concreting. Bond efficiency is dependent on:**
 - bar orientation (horizontal - vertical - inclined)
 - bar position (top - bottom)
 - bar spacing
- **Design loads.** The lap length required for bars in tension is much longer than for the same size bars in compression. A lap designed for compression load will not perform as a full tension splice. In the event of misuse or abuse of a structure, lap splices may increase the risks.

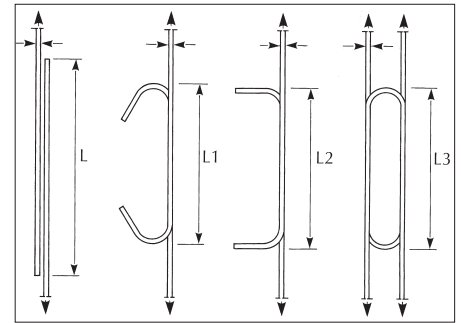

Fig. 1 - Forms of lap splices.

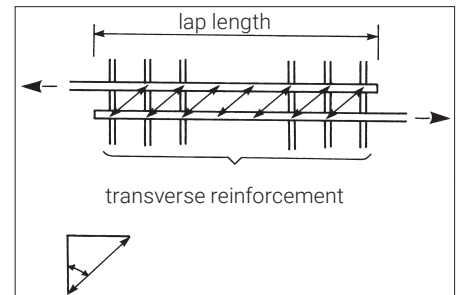

Fig. 2 - Mechanism of lap splice with transverse bars.

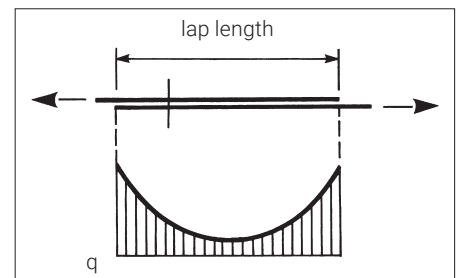

Fig. 3 - Distribution of transverse forces in concrete.

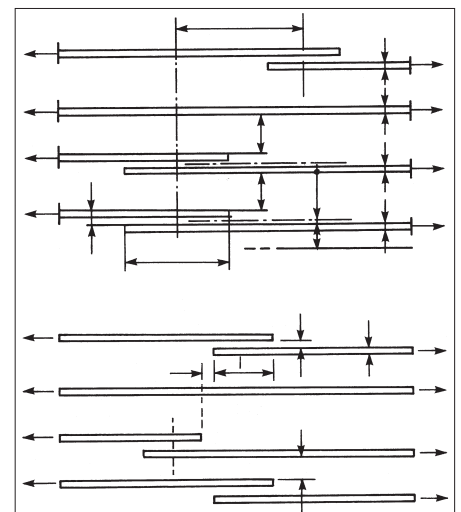

Fig. 4 - Design and execution of lap splices.

Why a Mechanical Splice is Best in Reinforced Concrete

Due to these parameters some rules for design and execution of lap splices must be obeyed (see fig. 4):

- joints must be staggered
- only a limited number may be joined in one section.
- additional transverse reinforcement is necessary for larger sizes.
- in the area of overlap connections a double number of bars are present, which can restrict the flow of larger aggregates and cause difficulties in the efficient vibration of the concrete.

In conclusion: the traditional overlap splice has few advantages and many many disadvantages, but if it is intended to substitute another type of splice in place of the overlap then the chosen splice must at least equal the performance of an overlap splice and should eliminate the disadvantages and design restrictions.

The ideal splice would be one that displayed no change in the properties of the reinforcing bar itself. This highly desirable situation is not attainable even if only due to the "scatter" of physical properties allowed.

The optimum technical solution for splices should address the following features in respect of splice performance:

1. Full load transfer of the specified strength of the bar under tension or compression loading.
2. Restriction of permanent slip (non-linear elongation) across the splice.
3. Limitation of increase of cross section.
4. Resistance to cyclic loading.
5. Performance under impact loading.
6. Resistance against effects of fire.
7. Adequate ductility at low temperatures.
8. Performance under repeated high speed loading.
9. Electrical conductivity to avoid damage from lightning or electrical short circuit.
10. Limitation of length of splice.

In most national codes only some of the above features are addressed - primarily items 1 and 2 and several forms of splices are available to satisfy these limited requirements. In the following sections some guidance on choice is presented.

Fig. 5-8 shows various applications where mechanical splices are used to great technical and economic advantage - simplified design and execution - improved robustness and durability - reduced cost.

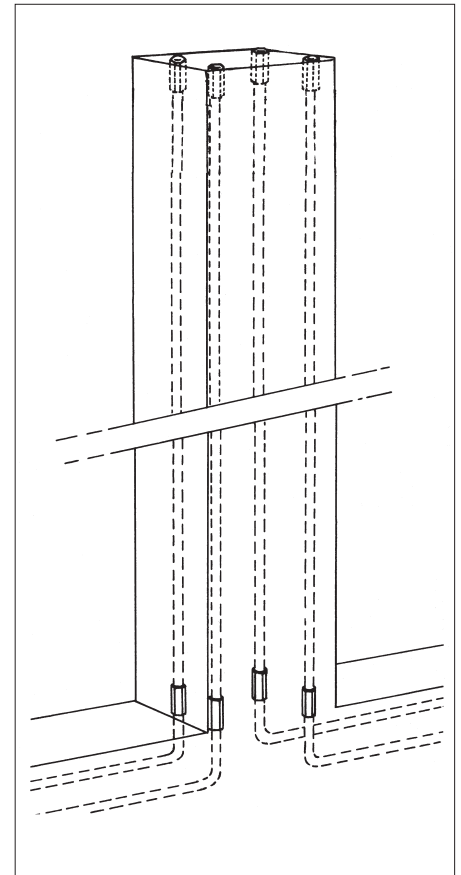

Fig. 5 - Optimum size member.

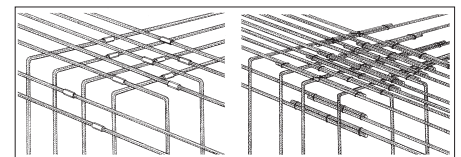

Fig. 6 - Reduction of congestion.

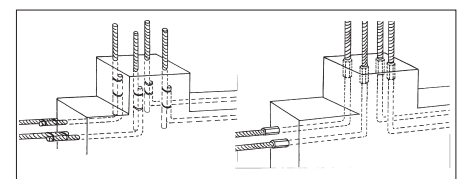

Fig. 7 - Simpler and safer construction.

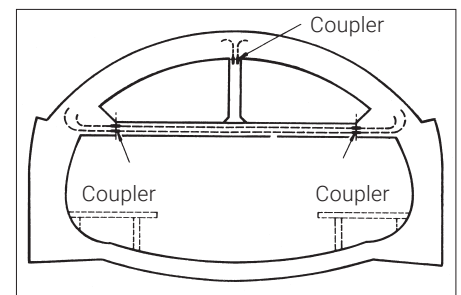
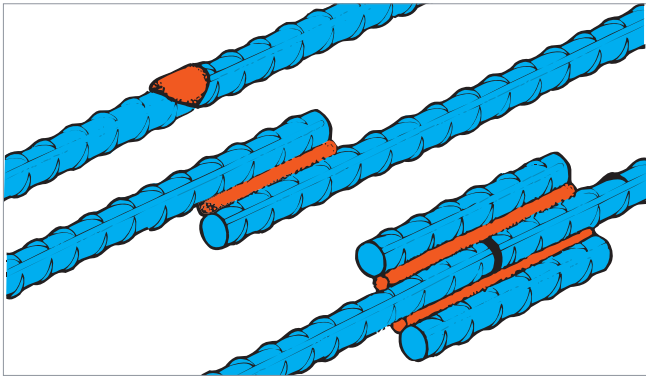

Fig. 8 - Tunnel cross-section - Economy in construction.

Ways of Connecting Reinforcing Bars



WELDING

Electric arc with coated rod.
Electric arc with inert gas shield (MIG).
Flash butt welding.
Butt joint, overlap or splint joints and right angle cross joint can be achieved with welding.

Advantages:

Full static performance can be achieved but dynamic loading is much reduced.
Cross joints are stiff and easily transportable cages can be fabricated.

Disadvantages:

Weldable steel grade must be used.
Special equipment is needed on site.
Specially skilled welders are needed.
Quality Control is expensive.

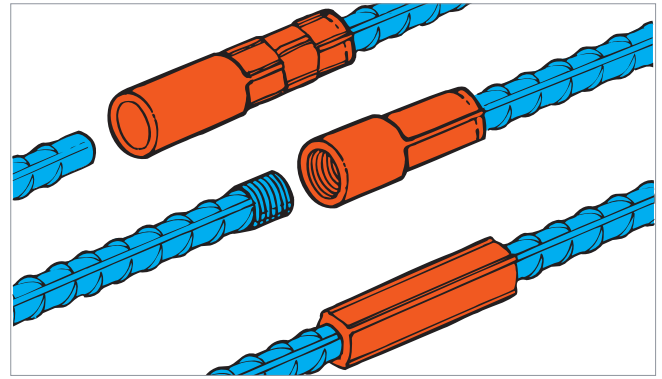

SWAGING

Butt joints may be made by swaging down a steel sleeve to fit tightly over the bar. The ribs of the bar are impressed into the sleeve wall.
Fully swaged connections as well as combined swaged and threaded bar are found.

Advantages:

No special preparation of bar ends, but end must be free from burrs, tags or bends.

Disadvantages:

Bulky equipment, slow operation. Splice efficiency is reliant on good bar deformations and adequate cross section.
Control of variables is difficult and sub-standard splices can remain undetected. Not suitable for plain surfaced bars.

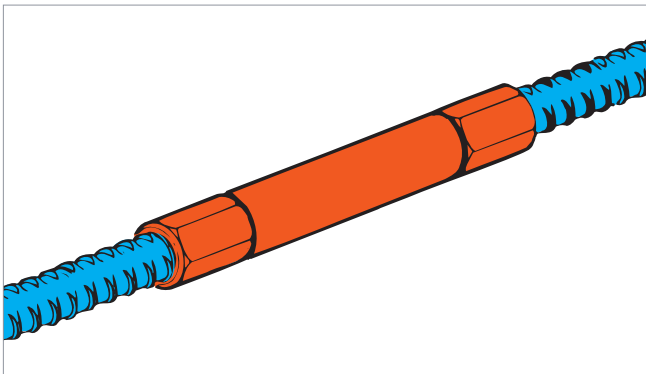

THREAD-FORM REBAR

Uses a special reinforcing bar in which the ribs form a coarse thread, butt joints can be achieved using a threaded sleeve and lock-nuts.

Advantages:

No special preparation of bar ends, good fatigue resistance, good impact resistance.

Disadvantages:

Expensive special steel must be used, lock nuts requiring a very high locking torque are necessary, the coupling is large and long. Bar ends must be free from tags and bends.

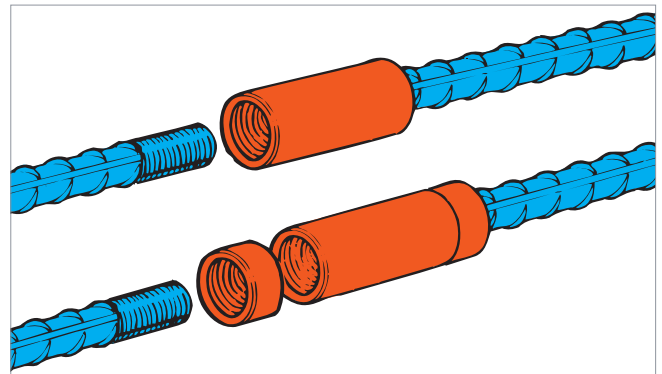

PARALLEL THREADED BAR END

Reinforcing bars are threaded at their ends and a butt joint is made using a sleeve and lock-nuts.

Advantages:

In its simplest form it can be produced with standard available equipment.

Disadvantages:

Reduced cross-section, careful alignment is necessary to avoid crossed threads.
Precise installation required and long installation time, reverse load performance is poor without lock-nuts.

What is a Good Connection?

THE NVENT LENTON CONNECTION

The nVent LENTON reinforcing bar coupling has all the desirable features itemised in the concluding paragraphs of section 1 combined with unequalled simplicity of installation.

The nVent LENTON taper thread ensures that the bars are correctly centered in the coupler, so ensuring the correct engagement length of each thread.

The nVent LENTON taper thread ensures that both flanks of the bar thread are firmly in contact with both flanks of the coupler thread.

This means virtually no movement occurs in the splice even under reversal of loading and no lock-nuts are needed to achieve this condition of very low slip.

Therefore taper threads used for nVent LENTON couplers provide maximum security.

The nVent LENTON taper thread coupler is quickly and easily inspected for correct assembly enabling efficient quality assurance.

nVent LENTON couplers are both short in length and small in diameter relative to the bar size being spliced. The short length means the least disturbance to uniform stiffness of a spliced bar and the small diameter means no increase of cover is required because of the spliced bars.

The taper-thread system ensures very easy quick and trouble-free assembly. The bar can be inserted into the coupler over a wide angle of misalignment with no danger of crossed threads, and the taper-thread will automatically align the bars as tightening proceeds.

The high efficiency of the nVent LENTON splice combined with all the other desirable features it possesses makes nVent LENTON the **Really Good Connection**

Product Approvals

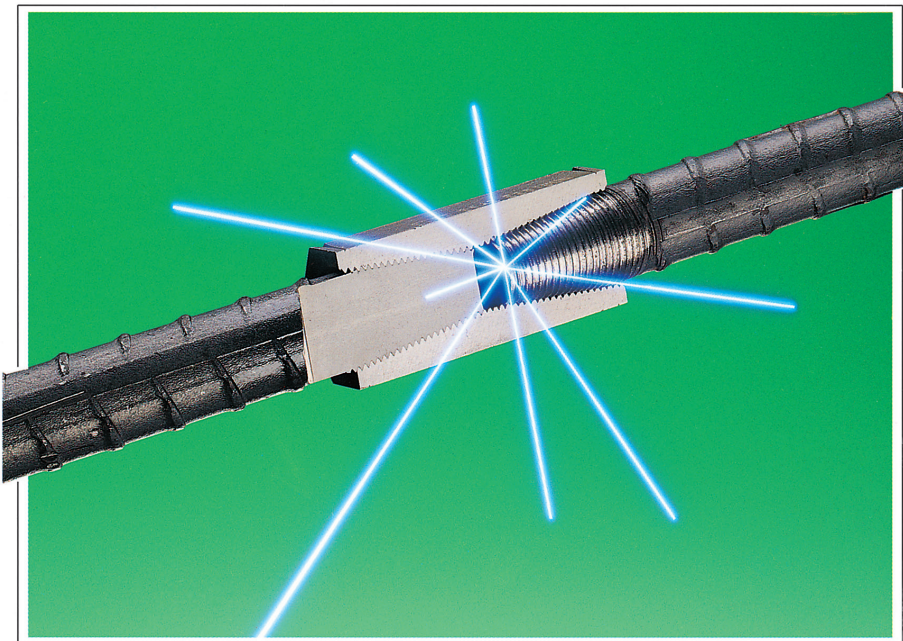
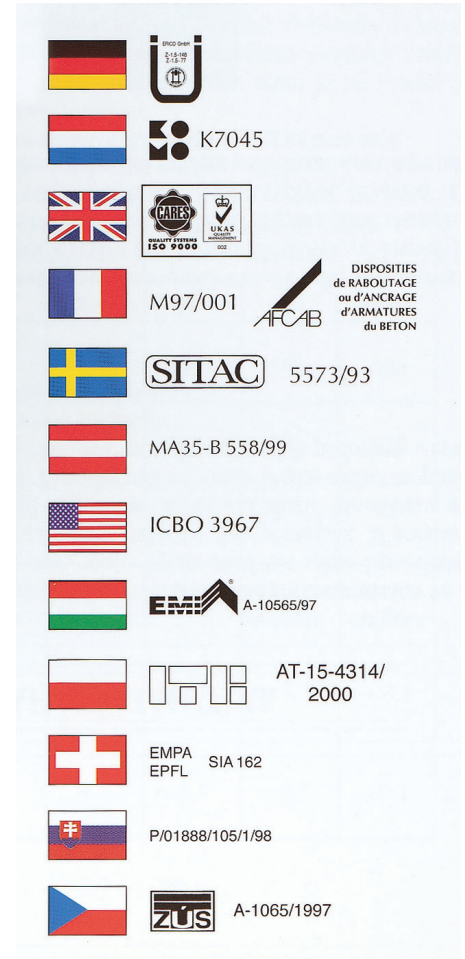

Tensile Test - Load Carrying Ability

BEHAVIOUR UNDER TENSION

The essential test which reveals the efficiency of a splice is a tensile test. This basic test is done in the following way: - two bars are spliced with a coupler and the sample subjected to an increasing tensile load to break. This ultimate load will be compared with:

- the nominal tensile strength for the grade of steel tested, for example 550 N/mm² for BSt500 S steel, and
- the actual strength of the parent bars to obtain the relative loss of strength between spliced and unspliced bars.

In the test the failure mode and the elongation at maximum load of the bars will be noted.

Criteria for assessment of the test results are different from country to country but common criteria are:

- the nominal tensile strength must be reached
- the coupler should never break
- the relative decrease of tensile strength between spliced and unspliced bars should equal or better the ratio defined in the relevant national code being followed.

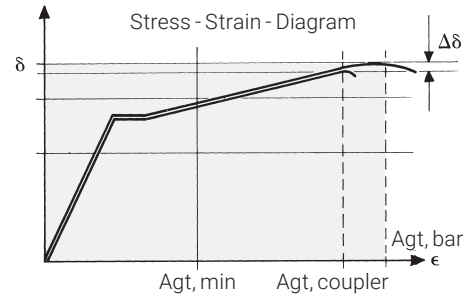

Figure 1: shows the comparison between a tensile test of a spliced and an unspliced specimen. In this case a small reduction of the actual ultimate tensile strength of the parent bar is indicated.

Cumulative distribution of tensile Grade 500 all sizes test results on nVent LENTON couplers

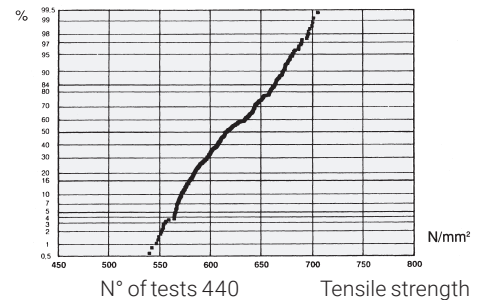

Figure 2: shows statistical analysis of test results by means of accumulative frequency distribution on a large number of tensile tests of nVent LENTON couplers on German Rebars. It is evident that the minimum requirements are constantly met.

LOAD REVERSAL TESTS - TENSION/COMPRESSION

In some construction elements the direction of loading can change due to wind force, centrifugal force or other reasons and result in the reinforcement, including the splices, needing to resist both compression and tension stresses alternately. Some coupling systems show large increases of "slip" when subjected to reversal of load.

Most "slip" testing does not address this feature. Realistically "slip" testing should include measurement made where a change of stress direction is included in the assessment of "slip" for the system.

nVent LENTON splices have been tested in Europe and U.S.A. and the severe conditions for testing in U.S.A. were as follows:

- Tension loading up to 2, 3, 4 % strain.
- Reverse loading to about 100 N/mm² compression.
- These cycles repeated 10 times.

The test execution follows a US experimental draft ACI 439. Tests have been performed on couplers, size 25 mm, with steel grade 60 according to ASTM 615. The result of one test with a maximum strain of 4 % is shown in the figure. It is evident that no inelastic movement occurs under reversal of load nor repeated reversal of load.

Consequently, the nVent LENTON coupler meets the requirements for tension, compression and cyclic loading.

Cyclic Testing #8 nVent LENTON Splice (ref. 4% Strain Test)

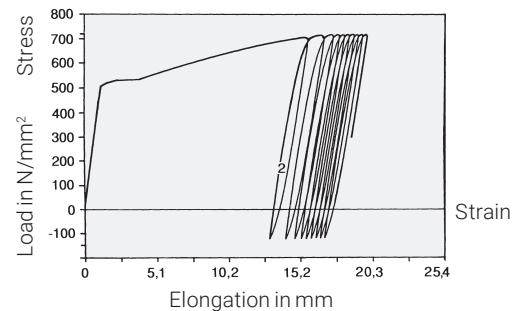

Performance Testing

SLIP MEASUREMENT

The slip of a mechanical splice is measured in a tensile test. The common method in the past was to determine the relative elongation of a splice versus the unspliced bar as shown in figure 1.

nVent LENTON couplers of all sizes and types meet the requirement, which permits an overall slip of 0,1 mm at the admissible load.

Meanwhile the experts are conscious of the fact that this testing method is incomplete. The relative movement between the bars and the two ends of the coupler is of significance (see fig. 2) and must also be determined.

Tests on nVent LENTON couplers performed with this correct method, proved that the couplers are suitable also for the new requirement which demands that the total slip and the slip at both ends is not greater than 0.10 mm.

Some examples:

TYPE OF COUPLER	SLIP E1	SLIP E2	SLIP TOTAL
EL-12-A12	0,030	0,030	0,011
EL-25-A12	0,029	0,031	- 0,011
EL-40-A12	0,036	0,035	- 0,003
EL-25-P13	0,026	0,033	- 0,008
EL-25-P15	0,030	0,032	0,007

nVent LENTON is the first and unique producer of mechanical splices which offer couplers which meet the requirements of the advanced test method.

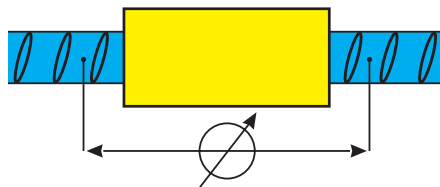

Figure 1

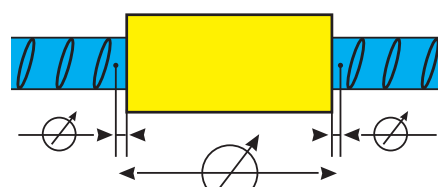

Figure 2

TENSILE TESTS UNDER CONDITIONS OF HIGH SPEED LOADING

Some design practices (earthquake, impact) demand a knowledge of material behaviour at high loading speed. Usual tensile tests on rebars and couplers are performed at about 20 N/mm²/sec (0,001 mm/mm/sec). Extrapolation to higher loading rates is not permitted.

To obtain the necessary information nVent charged EMPA (Eidgenössische Materialprüfungs- und Forschungsanstalt, CH-8600 Dübendorf, Switzerland) to execute appropriate tests at about 1000 times the normal loading speed.

These tests showed the behaviour of nVent LENTON couplers in tensile test at low and high speed to be identical.

The increase of resistance of the parent bars due to high speed loading is balanced (met) by the coupler system.

Mode of failure remains the same and the results of a series of tests are tabulated in the table.

	Low Speed ca. 0,001 1/sec.		High Speed ca. 1,15 1/sec.		
	Bar	Coupler	Bar	Coupler	Coupler
Yield Stress (N/mm ²)	572	570	599	599	596
Ultimate Tensile Strength (N/mm ²)	676	644	715	681	675
ε max (%)	10,0	4,0 3,6	11,0	4,8 4,0	4,0 4,0
Mode of Failure	bar	thread in coupler	bar	thread in coupler	thread in coupler
Change in Yield Stress (*) (%)	-	0,3	+ 4,7	+ 4,7	+ 4,2
Change in ultimate Tensile Strength* (%)	-	4,7	+ 5,7	+ 0,7	- 0,1

*bar without coupler ε = 0,001.

Performance Testing

BEHAVIOUR AT LOW TEMPERATURES

In normal circumstances concrete structures are not expected to experience temperatures below minus 50°C but where the structure contains liquid gas it is possible for the structure to be subject to temperatures as low as minus 164° C. Some testing has been carried out on nVent LENTON couplers to show the suitability of the nVent LENTON mechanism for use at very low temperatures.

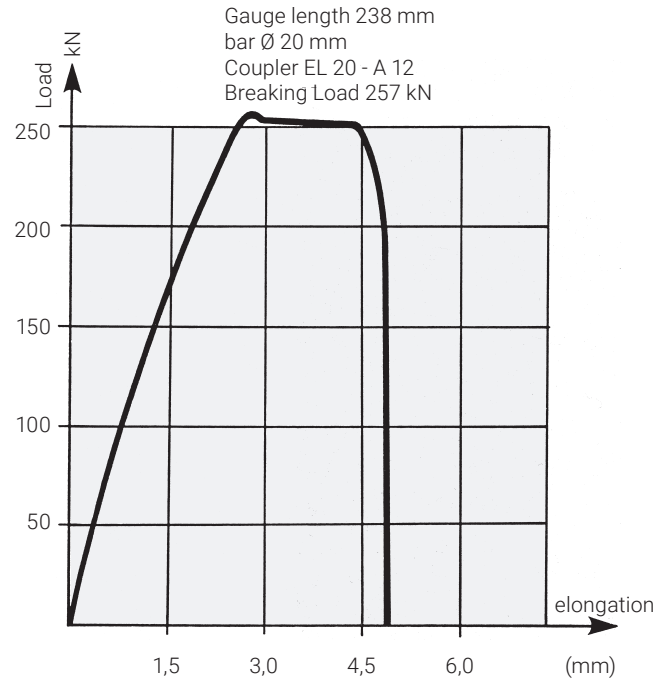

Above figure shows a load/elongation diagram from one of the test samples at minus 160° C. The diagram shows that the nVent LENTON coupler can match the strength increase of the steel bar due to the low temperature and also develop elongation under these conditions. In each case the tests were terminated due to failure of the bar clear of the coupler.

ELECTRICAL CURRENT CARRYING CAPACITY

In many constructions it may be advantageous to use the reinforcement for electrical purposes and examples are:

- to form a "Faraday cage" for protection of sensitive equipment
- to form a return path for fault currents in rail tunnels
- to conduct lightning currents safely to earth through a structure.

As the safety earthing examples given demand the highest performance requirement nVent co-operated with the Research Centre of the Deutsche Bundesbahn to carry out standard short-circuit testing on A- and P-type couplers.

Description of tests:

The couplers were installed in a normal manner. The test conditions were as follows:

Intensity of current amperes	Duration of applied current seconds
5000	10
10000	2,3
20000	0,6
30000	0,25

Fréquency: 16 2/3 hz.

In each case 3 pieces have been tested. To detect changes or irregularities in the coupler during current flow the voltage drop across the joint was measured by use of an amplifier.

Test result:

Figure 1 shows the oscillograms of one of the tests. The oscillograms show that no irregularities such as welding or loss of cross section were experienced in the test.

After the tests the couplers showed no damage to the threads.

As a conclusion, it can be clearly stated, that nVent LENTON couplers even under short circuit conditions provide an efficient current carrying connection.

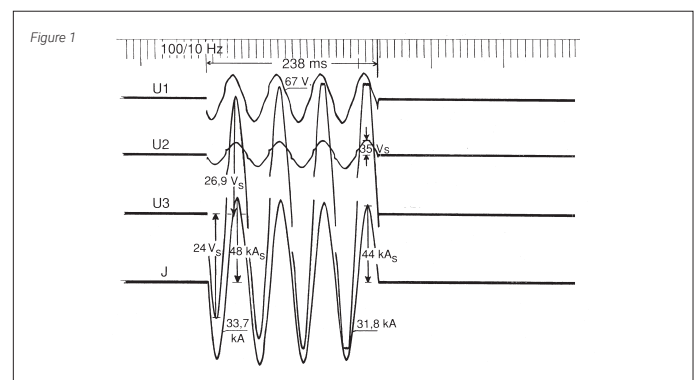

Performance Testing

FATIGUE TEST

Many series of tests concerning fatigue resistance of nVent LENTON couplers have been performed in different countries. The reason for so many tests is that test criteria and methods differ worldwide. In Europe a certain homologation will be reached due to European standardisation.

The relevant document is based on CEB MODELCODE 90. This design code gives values for mechanical connectors. The data is as follows:

Type	N*	Stress Exponent	$\Delta \sigma$ Rsk (MPa)	at N*	at 10 ⁸
Mechanical Connectors	10 ⁷	3	50	5	30

The fatigue strength function is composed of two segments (intersection at 10⁷ = N_x) and has the format:

$$(\Delta G_{Rsk})^m \cdot N = \text{const}$$

The figure below shows the characteristic S-N curve for mechanical connectors, based on the indicated values is plotted together with a S-N curve for nVent LENTON couplers. This S-N curve results from those of the numerous tests.

It is evident that the nVent LENTON couplers provide a significantly higher fatigue resistance than demanded by the design code.

Tests with a swing of 70 MPa and below all had run-outs at 10⁸ cycles.

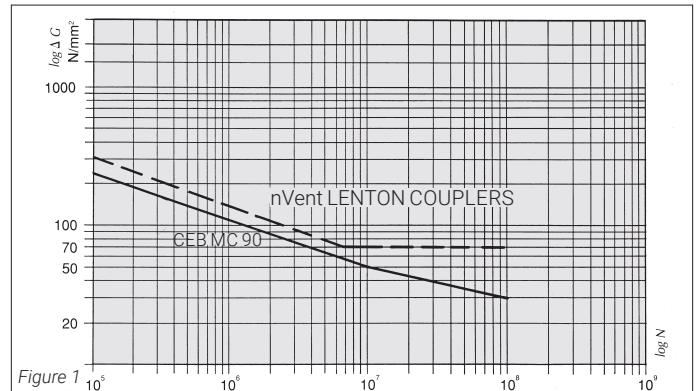

SHEAR TEST

The definition of shear resistance of couplers for rebars includes a twofold objective.

The first one is to test the mechanical shear strength of a connection. It is obvious that in this case only the physical shear resistance of a steel bar is measured. This is well known and of no importance for the designer.

The 2nd item is the interaction of the splice with the concrete. Shear loads cause high pressure locally in the concrete. Some series of tests have been done at the Technical University of Munich for different tension load/shear load combinations and coupler sizes. An interaction diagram has been established, see fig. 1. This diagram is based on a safety factor of 1.75 and the assumption that in the direction of the shear force no larger movements than 2.5 mm are permitted.

The test set-up used at the Technical University in Munich is shown in fig. 2.

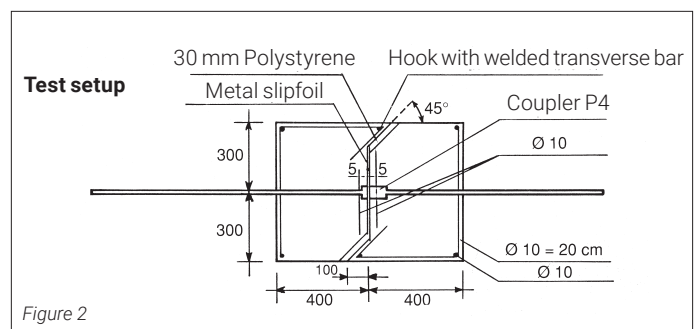
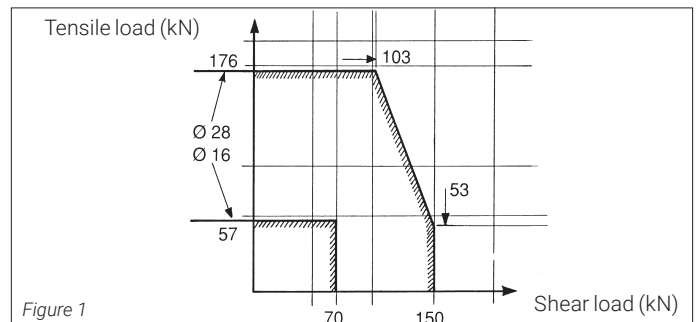

Universal nVent LENTON System

ALL GRADES OF STEEL WITH NOMINAL YIELD VALUES UP TO 550 MPA AND TENSILE STRENGTH VALUES UP TO 750 MPA Φ 10 TO 57 MM

TYPE A12 & A2

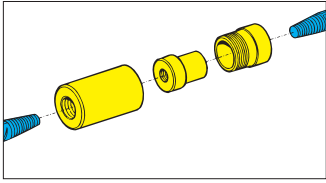

Coupler types A12 & A2 are for use in situations where one or both of the bars to be joined are free to turn.

This situation is the most common of all and covers over 90% of the coupler usage.

The LENTON A12 & A2-type couplers are ideal for all locations where the ongoing bar is free to turn - or can be made free to turn - as its short length, slim diameter and extremely low 'slip' combine to make its effect close to that of a continuous bar. Where bars are very close together or where space is severely restricted the A12 & A2 couplers provide a splice of absolutely minimum dimensions.

TYPE P13 & P8

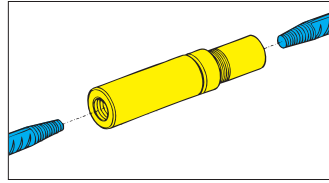

The P13 & P8 couplers are designed to use where neither bar is free to be turned and the ongoing bar is restricted in its axial movement. Due to the long parallel thread section, the P13 & P8 couplers are capable of making such a connection as a closer bar.

A typical application is splicing of prefabricated cages where the adjustment of the P13 & P8 will allow for the necessary cage fabrication tolerances.

TYPE P14 & P9

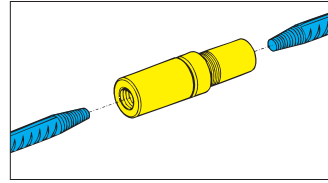

The P14 & P9 type couplers are also designed for applications where neither bar is free to be turned but where the ongoing bar is movable in its axial direction. Although the parallel threaded section of the P14 & P9 couplers are shorter than the P13 & P8, the P14 & P9 couplers have the adjustability required in positioning the ongoing bar (5-6 mm).

Typical application is splicing of bent bars.

TYPE P15

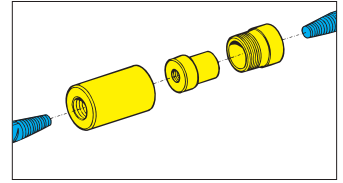

The P15 is constructed in a way that avoids a fixed pitch relationship between one end of the coupler and the other. This feature used in combination with the adjustability of the P13 facilitates the forming of a "closer" suitable for column erection or precision coupling of elements with multiples of bars to be joined over a short span. Typical applications for P15-P13 combination are splicing of prefabricated elements and closing of small temporary openings.

TYPICAL APPLICATION TYPE A12 & A2

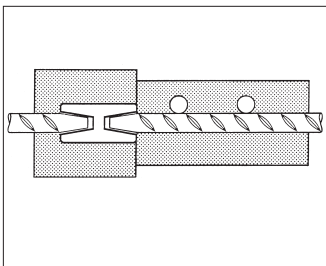

TYPICAL APPLICATION P13 & P8

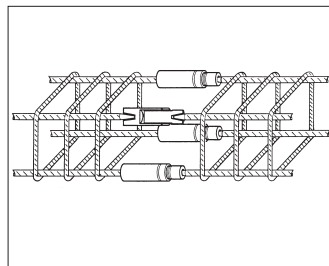

TYPICAL APPLICATION P14 & P9

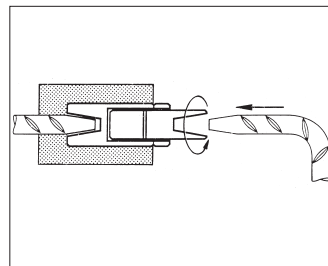

TYPICAL APPLICATION P15

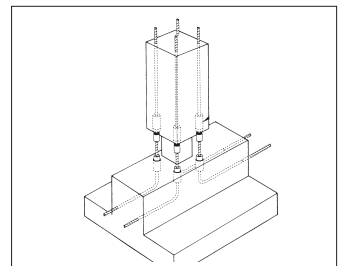

Practical Way: How to use nVent LENTON System

TYPE C12 & C3J

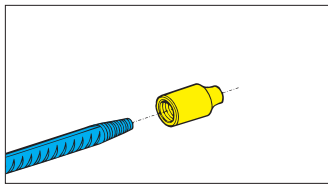

The C12 & C3J couplers are made for joining reinforcing bars to structural steel sections or plates. The coupler is made from a weldable steel and formed with a "J" groove to facilitate a full-penetration weld. Welding should be carried out by a skilled welder and the recommendations of the local Welding Institute and relevant Standards should be followed. When welding, please, fit plastic push-in plug afterwards.

TYPE S13

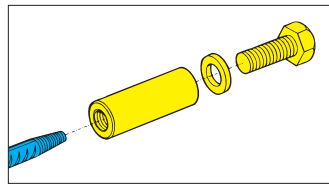

The S13 couplers provide a full strength joint between a reinforcing bar and a metric threaded bolt. The coupler may be used as a heavy duty fixing for load carrying steel structures bolted to concrete foundations, columns or walls. Examples of these situations are found in pylon bases, fixing crane rails and fixings for heavy pipe work, walk-ways etc.

The S13 coupler is manufactured from a non-weldable steel grade. It can be tack welded for positioning purposes but the welds are not structurally strong. S13 type couplers also make a convenient transition from reinforcing bar to threaded stud which maintains the full strength of the bar. This transition is useful when forming long tie-bars such as may be used to hold the formwork or pile-planks against internal pressure and also to form a restraint anchor for ground anchors.

TYPE D14 & D6

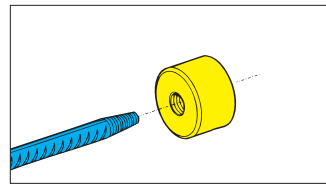

The D14 & D6 couplers provides an anchor-or stop nut, particularly for a reinforcing bar passing through a pile plank or structural steel element. The front face (bar side) of the coupler is generously proportioned to carry the full tension load of the reinforcing bar when the nut is bearing against structural steel.

The material of the D14 & D6 are not considered good for structural welding but can be welded for positioning purposes. The D14 & D6 can be used with or without a suitably proportioned steel plate to form an effective anchorage for the bar in concrete.

INSTALLATION OF COUPLERS

The nVent LENTON tapered thread is a high performance load transferring mechanism which is extremely easy to install!

It eliminates alignment and centering problems and takes only 4-5 rotations to complete! The small bar thread point diameter makes it very easy to insert the bar into the coupler mouth which will give immediately support and guidance.

The tapered bar thread is insensitive for partial thread damages which may occur on the job site. In that case, the thread connection can still be made since the remaining threads will still match and during tightening, the damaged threads will automatically be re-shaped.

The tapered threads perform well over a wide range of tightness and even hand tight will give good characteristics. To ensure joints remain tight during transport, handling and vibration of the concrete during placing it is recommended to tighten them with a wrench.

In practice, it is found that construction workers tend to tighten the connection unnecessarily tight. Therefore nVent supplies adjustable wrenches which indicate sufficient tightness of the connection.

TYPICAL APPLICATIONS C12 & C3J

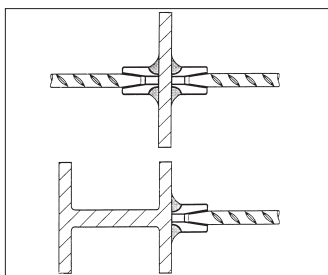

TYPICAL APPLICATION S13

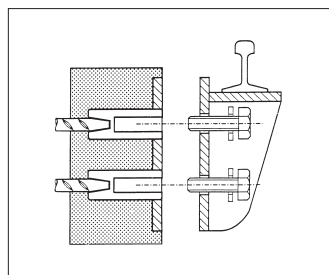

TYPICAL APPLICATION D14 & D6

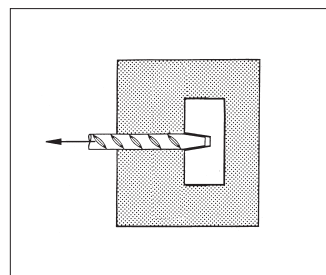

Reference List and Projects

EXTRACT FROM REFERENCE LIST NVENT LENTON PROJECTS

COUNTRY	JOB NAME + LOCATION	APPLICATION	COUNTRY	JOB NAME + LOCATION	APPLICATION
Belgium	European Community Brussels Brussels Metro	Office building Metro stations, tunnels	Portugal	Metro-Expo Lisboa	Metro
France	Grand Arche de la Defense Paris SNCF EOLE Paris	Office building TGV stations & bridges Metro	Bahrain	Bahrein Cause way (Bahrein - Saudi Arabia)	Prefab Bridge structure
Germany	Boxberg & Lippendorf Tiergarten Berlin Elbtunnel Hamburg Commerzbank Frankfurt	Powerstations Tunnel Tunnel Highrise office building	Saudi Arabia	Bunkers, shelters	
Netherlands	Nato Amsterdam Airport Nationale Nederlanden Rotterdam	Bunkers Control tower Highrise office building	Pakistan	Harbor project	
Italy	Siliana dam Milano Pininfarina Torino Alto Lazio	Dam Factory Nuclear Power Plant	United States	Marriott Copley Place, Boston Motorola, Austin Rock-n-Roll Hall of Fame & Museum, Cleveland Olmsted Lock and Dam, Olmsted Hanford Nuclear, Hanford BWI Int'l Airport Parking Garage, Baltimore 105 Century Freeway, Los Angeles San Diego Convention Center, San Diego Hyperion Waste Water Plant, Los Angeles	Hotel Commercial Building Museum Lock and Dam Nuclear Waste Vitrification Facility Parking Garage Highway/Bridge Convention Center Water Treatment Facility
Spain	Sevilla Expo 1992 Madrid - Sevilla Barcelona Olympic Stadium	Bridges, Congress Hall TGV bridges & viaducts Stadium	Canada	Toronto Skydome, Toronto, Ontario	Stadium
Switzerland	Felseman Brucke Val du Moulin, Feldtobelbrucke Chlus-tunnel Landquart	Powerstation Bridges Tunnel	Brasil	Tucuruí Dam	Hydro Electric Power Station
Sweden	Malmö - Travemunde Øresund Crossing	Ferry terminal Tunnel	Australia	Australia Stadium (Sydney) Melbourne Casino Wandoo Oil Platforms Sydney Harbour Tunnel	Stadium Casino Off Shore Platforms Tunnel
Denmark	Storebaelt West Bridge Storebaelt Eastbridge	Prefab Bridge Structure Suspension bridge	Malaysia	Petronas Towers Kuala Lumpur International Airport Sunway Lagoon Resort	Office & Shopping centre Airport Property Development
Norway	Troll Olje Plattform	Off shore	Hong-Kong	Bank of China Chek Lap Kok Central Plaza Kap Shui Mun Lantau-fixed Crossing Ting Kua Bridge	High-rise office building Airport High-rise buildings Bridge Bridge
United Kingdom	Channel tunnel Sellafield Sizewell B Hamilton oil & gas platform Jubilee Line London	Approach road Thorp reprocessing plant Nuclear Power Station Off shore Metro stations	China	Daya Bay Guangdong Shanghai Metro Shajiao C	Nuclear power plant Metro stations, tunnels Power Station
Greece	Athenes Metro Revithoussa LNG Tanks	Metro LNG Tanks	Singapore	Changi Airport Terminal 2 Pacific Plaza Singapore MRT	Airport Office & Shopping building Mass Transit

Projects



Nationale Nederlanden - Rotterdam (NL)



F3 - Platform NAM - Rotterdam (NL)



Control tower - Schiphol Airport - Amsterdam (NL)

Projects



La Défense - Paris (F)



Trianon - Frankfurt (D)



Bank Swiss Union (CH)

Projects



Messturm - Frankfurt (D)



Fernmeldeturm - Hannover (D)



Nuclear power station - Sizewell B (GB)



Storebaelt west bridge (DK)

Our powerful portfolio of brands:

CADDY ERICO HOFFMAN RAYCHEM SCHROFF TRACER



[nVent.com/LENTON](https://www.nvent.com/LENTON)

WARNING: nVent products shall be installed and used only as indicated in nVent's product instruction sheets and training materials. Instruction sheets are available at [nVent.com/LENTON](https://www.nvent.com/LENTON) and from your nVent customer service representative. Improper installation, misuse, misapplication or other failure to completely follow nVent's instructions and warnings may cause product malfunction, property damage, serious bodily injury and death and/or void your warranty.

©2018 nVent. All nVent marks and logos are owned or licensed by nVent Services GmbH or its affiliates. All other trademarks are the property of their respective owners. nVent reserves the right to change specifications without notice.

LENTON-SB-CP7H-C494LT09WW-EN-1805