

**CONNECT AND PROTECT**

# Taper Threaded Rebar Splicing Systems

For many years, the traditional method of connecting reinforcing bars has been with lap splicing. But as many structural engineers, architects and specifiers have discovered, lap splicing has very few advantages and quite a few disadvantages when compared to mechanical splicing. Read through the following pages and explore the reasons why you should consider mechanical couplers.

# Lap Splicing vs.

## Take A Look Into The Future: Which system do you want to rely on

### LAP SPLICING

#### IS IT RELIABLE?

- Lap splices develop their strength from interaction with concrete
- The higher the yield stress, the greater the lap length required
- Lap splices have poor cyclic performance
- To prevent concrete splitting, additional rebar may be required for confinement

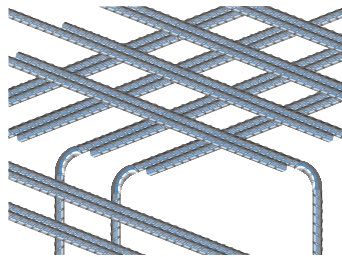
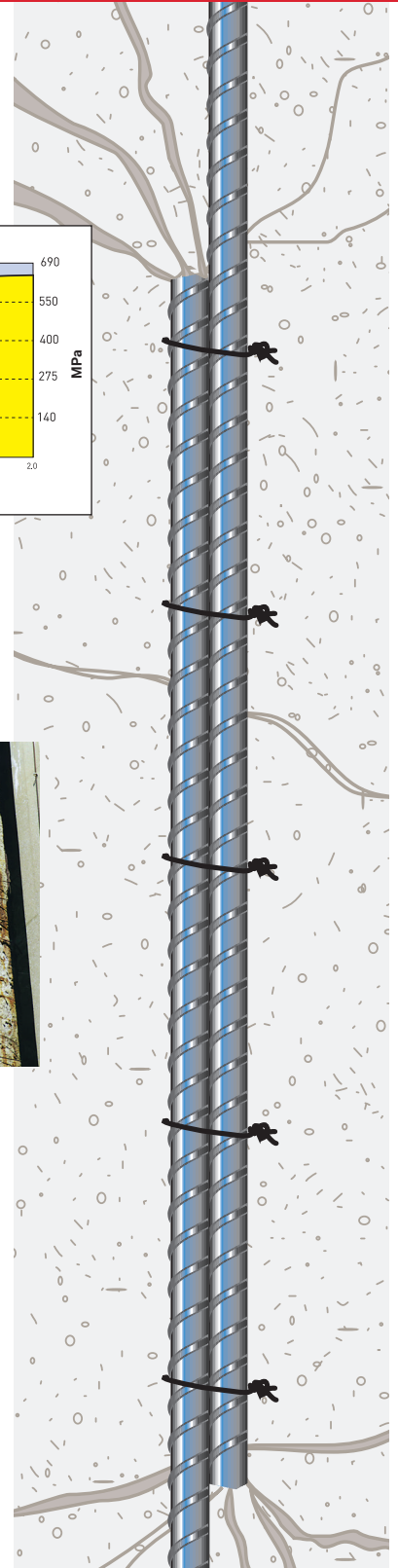
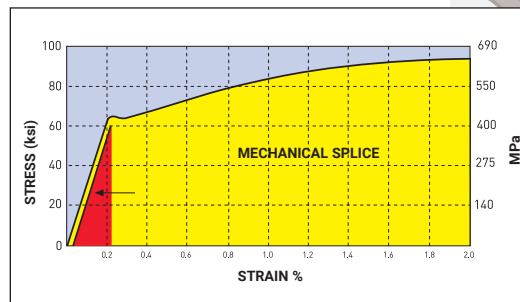

#### DESIGN-CONSTRICTIVE

- Lap length required for bars in tension is normally longer than same size bars in compression
- Lap splices double the number of bars leading to rebar congestion which can restrict the flow of aggregates



*Deterioration of concrete due to improperly designed rebar splices and lack of reinforcement, often leads to premature splice failure.*

#### HIDDEN COSTS

- The bigger the bar diameter, the longer the lap
- The lower the concrete strength, the longer the lap length required
- Corrosion-resistant coated bars are expensive and longer lengths may be used
- Lap splicing involves time consuming calculations, possible calculation mistakes, and overestimating

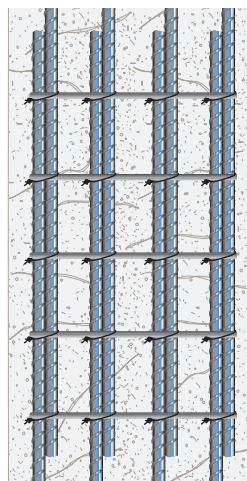

*Lap splices depend on concrete for strength, and therefore lack structural integrity and continuity in concrete construction.*

# Mechanical Splicing

for continuity in your concrete construction projects?

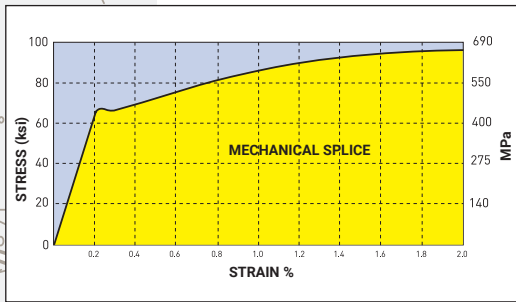
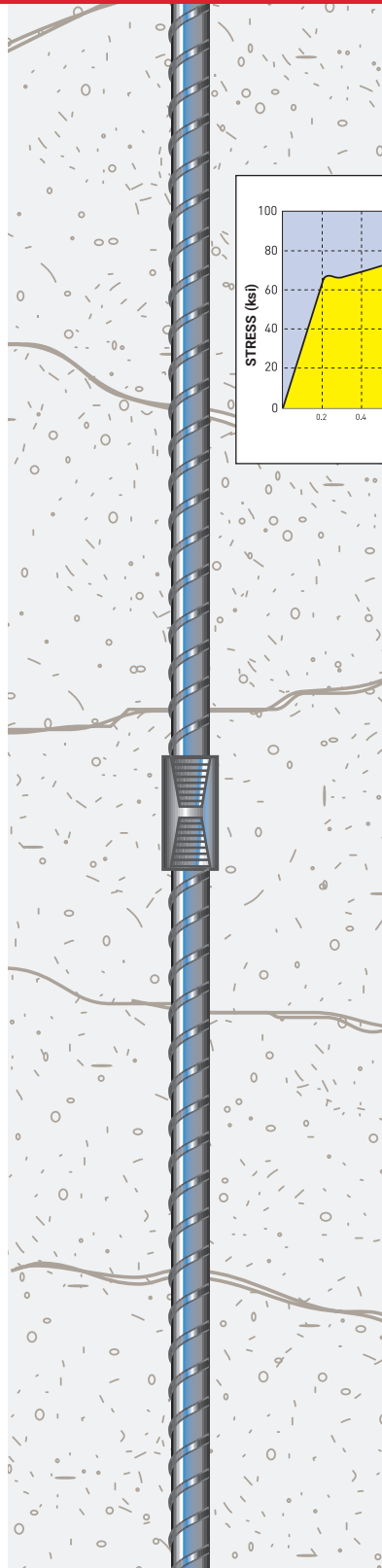

Mechanical splicing provides significantly higher strength by design than lap splicing.

## DESIGN-FRIENDLY

- Reduces rebar congestion and improves concrete consolidation
- Improves steel-to-concrete ratio
- Eliminates lap splices in high stress regions
- Allows greater flexibility in design options

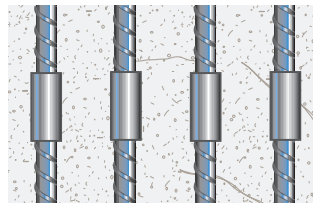
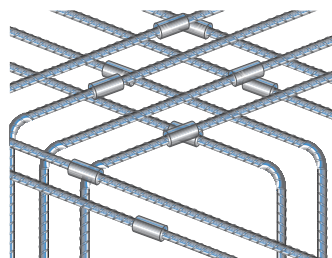

## ECONOMICAL

- Requires no special skills and reduces labor costs
- Accelerates construction schedules for reduced cost and improved efficiency
- Saves valuable crane time
- Reduces material costs because less rebar is used

## ADDITIONAL ADVANTAGES

- nVent LENTON offers an excellent current carrying capacity, or strike path, for grounding buildings
- Resistant to impact loads during man-made or natural events
- Increased column shear load capacity
- Promotes low cycle fatigue performance

Mechanical splicing provides the assurance of maintaining load path continuity of the structural reinforcement independent of the condition or existence of the concrete.

## nVENT LENTON MECHANICAL SPLICING

### PROVEN RELIABLE

- Performs similar to a continuous piece of rebar
- Splice strength is developed independent of concrete quality
- Provides ductility independent of concrete condition
- Achieves greater strength
- Offers strength during man-made, seismic or other natural events
- Superior cyclic performance

## TABLE OF CONTENTS

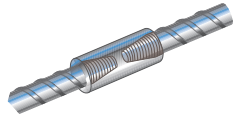
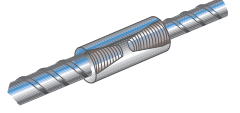
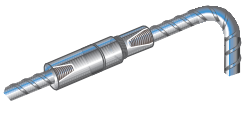
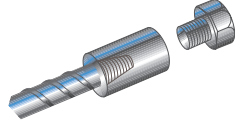
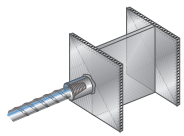
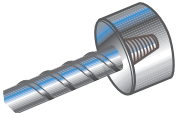
Lap Splicing vs. Mechanical Splicing .....	2 & 3
International Codes & Standards .....	4
nVent LENTON Taper Threaded Splicing System .....	4-7
nVent LENTON Projects .....	5
Applications .....	8-9
	
Standard Couplers .....	10
	
Transition Couplers .....	11
	
Position Couplers .....	12-14
	
Bolt Couplers .....	14
	
Weldable Couplers .....	15
	
nVent LENTON Terminator .....	16-17
nVent LENTON Equipment & Accessories .....	17-18
Other nVent LENTON Concrete Reinforcement Products .....	19
nVent LENTON – The Brand .....	19
How to specify nVent LENTON Taper Threaded Mechanical Splices .....	19

## INTERNATIONAL CODES & STANDARDS

nVent LENTON mechanical splices meet or exceed the requirements of major international codes and standards:

	<b>Australia</b> AS3600 Main Roads, RTA
	<b>Austria</b> ÖNORM EN 1992-1-1 ISO 15835
	<b>Brazil</b> ABNT NBR 8548:1984
	<b>Canada</b> CAN/CSA-N287.2; CAN/CSA-N287.3; CAN/CSA-N287.4
	<b>Chile</b> NCH 204
	<b>France</b> NF A35-020-1; NF EN 1992-1-1
	<b>Germany</b> DIN EN 1992-1-1
	<b>Italy</b> UNI 11240
	<b>Malaysia</b> MS146
	<b>Netherlands</b> NEN-EN 1992-1-1
	<b>Norway</b> NS 3437
	<b>Russia</b> POCC RU.0001.11AЯ12
	<b>United Kingdom</b> BS EN 1992-1-1; BS EN 1992-2
	<b>United States</b> AASHTO®; ACI® 318, ACI 349, ACI 359; ASME®; U.S. Army Corps of Engineers; IBC®; Numerous Dept. of Transportation

**nVent Lenton couplers are designed for nominal yield values up to 550 MPa and tensile strength values up to 750 MPa.**

### Recognized product approvals:

**Austria:** BMVIT-327.120/0016-IV/ST2/2012

**Croatia:** HTD 13/008

**Czech Republic:** TZUS 010-031705

**France:** AFCAB M97/001

**Germany:** DIBt Z-1.5-200; DIBt Z-1.5-245

**Hong Kong:** Hong Kong Building Dept.

**Hungary:** EMI A-1065-1997

**Italy:** IGQ P120; IGQ P138

**Lithuania:** SPSC-9065

**Poland:** ITB AT 15 4314/2008

**Romania:** AT 001ST-01-134-2013

**Russia:** GOST Pocc US CL87 H01186  
GOST R ROSS US SL87 N01475  
MOST RU.MCC.046 124 23614  
MOST RU.MCC.142 313 27792

**Slovakia:** TSUS SK04-ZSV-1885

**Sweden:** SITAC 5573/93

**The Netherlands:** KOMO/KIWA K7045

**Ukraine:** DSTU-N B V.2.6-155:2010

**United Kingdom:** Cares TA1B 5008

Cares TA1B 5012

Cares TA1B 5027

Cares TA1B 5029

Cares TA1C 5003

Cares TA1C 5009

Cares TA1C 5030

**United States:** IAPMO-UES Report 0129

IAPMO-UES Report 0188

ICC-ES ER-3967

# Taper Threaded Splices

## THE WORLD'S MOST WIDELY-USED

nVent LENTON Mechanical Splices, are a taper-threaded splicing system that assures a positive locking connection, providing continuity and structural integrity to reinforced concrete construction. nVent LENTON spliced bars behave as continuous lengths of reinforcing steel bars by providing "full strength" in tension, compression and stress reversal applications.

### THE UNIQUE TAPER-THREADED DESIGN

The nVent LENTON self-aligning, taper-threaded design provides ease of installation, consistent performance and durability. It also develops higher tensile strength than lap splicing and provides full load transfer with the slimmest and shortest coupler possible.

### DESIGN BENEFITS

- Allows maximum bar cross-section to be used
- Smallest diameter in the industry reduces need for concrete cover and eliminates rebar congestion
- Short length and slim design ensure the least disturbance to uniform stiffness
- Splice strength is independent of rebar deformation
- Unique tapered thread requires no lock nuts and provides a positive locking, no-slip connection
- Any length, shape, diameter or combination of bar sizes can be mechanically spliced

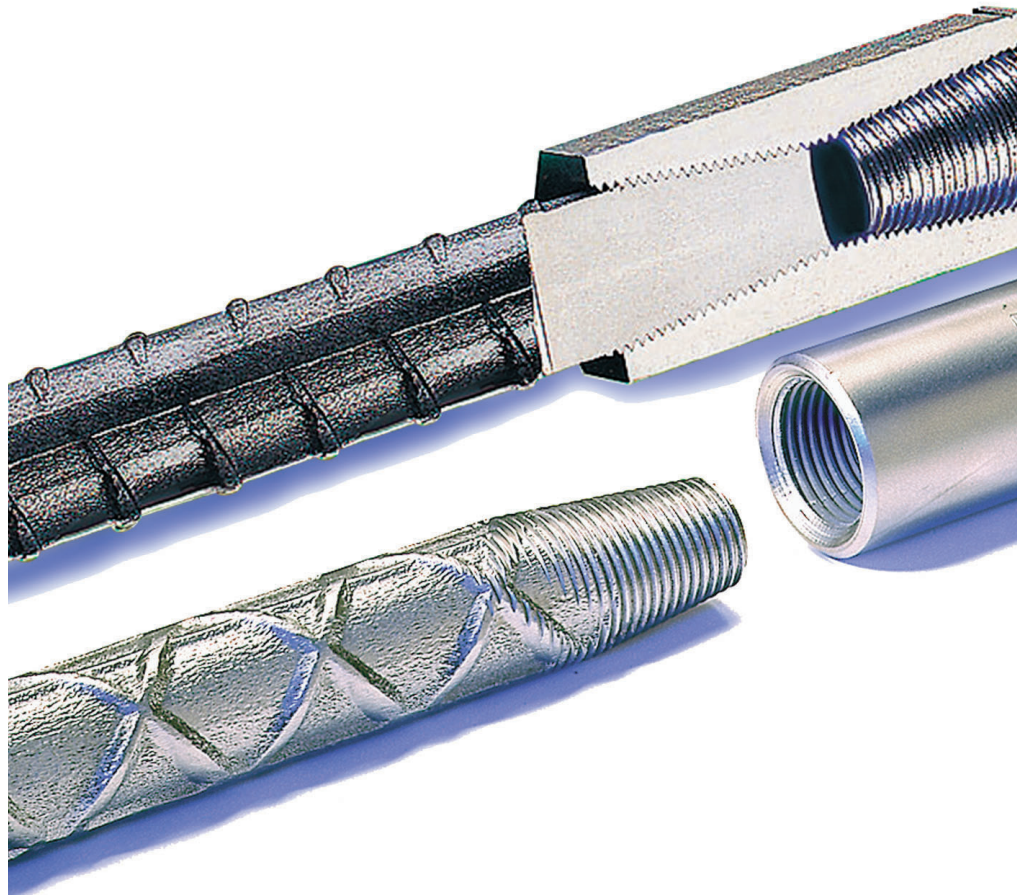

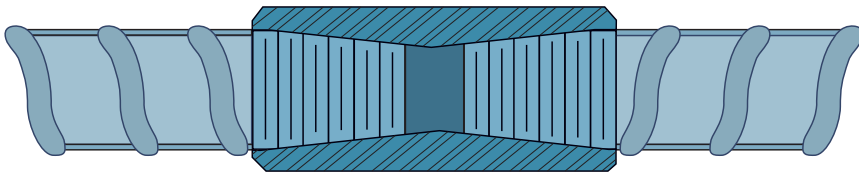

## METHOD OF MECHANICAL SPLICING

### INSTALLATION BENEFITS

- Takes approximately 4.5 turns to engage
- Prevents cross-threading
- Fastest system to install:
  - No special tools or skills required
  - No power required for installation
  - Splice inspection is quick and easy
  - Reduces crane time
- Bar threader is easy to use and can be set up on-site or at the fabricator
- Because most of the work is done in the fabrication shop, construction schedules are accelerated

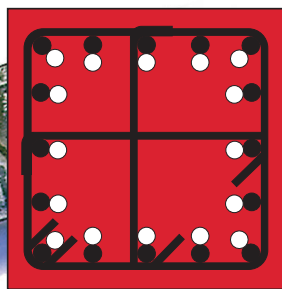
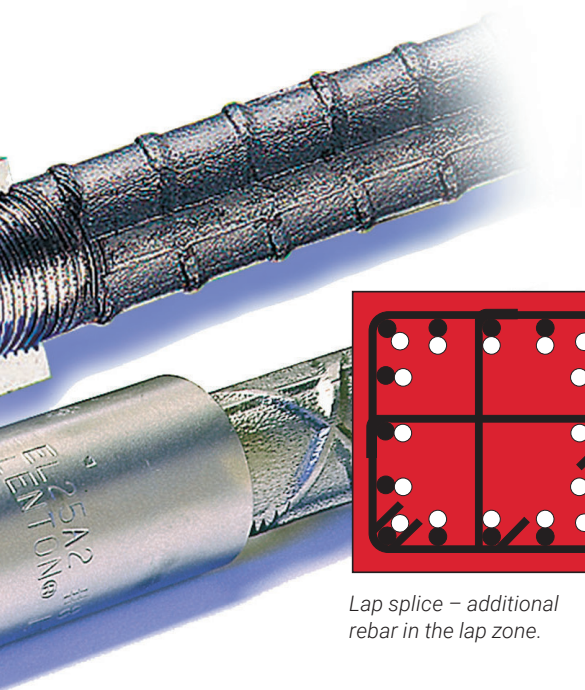

Lap splice – additional rebar in the lap zone.

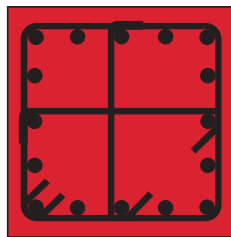

nVent LENTON mechanical splice – ideal balance of steel and concrete.































### PROVIDES CONTINUITY IN ECONOMY OF DESIGN

nVent LENTON improves steel-to-concrete ratio by eliminating half of the bars necessary in the “lap zone” of a column. Use of lap splicing may exceed the concrete to steel ratio of many international standards.

With nVent LENTON splices, you can design smaller columns and create maximum floor space, while reducing your form costs. Form sizes can also be established for more cost savings, and nVent LENTON couplers are excellent for future extension applications.

### PROJECT REFERENCE

nVent LENTON Mechanical Splicing system is used in a wide variety of projects around the globe. These are just a few examples:

-  **Australia**  
Australia Stadium (Sydney)
-  **Austria**  
Wiener U-Bahn, Abschnitt U3/22
-  **Bahrain**  
Bahrain Causeway
-  **Belgium**  
TGV Tunnel Zaventem, Brussels Metro
-  **Brazil**  
Itaipu Dam, Tucuruí Dam
-  **Canada**  
Toronto Skydome
-  **Chile**  
Cement Plant Bio-Bio
-  **Denmark**  
Storebaelt West and East Bridge
-  **Egypt**  
Conrad Hotel Cairo
-  **France**  
EOLE Lot 34 Gare Nord  
Grande Arche de la Defense Paris
-  **Germany**  
Lehter bahnhof, Berlin  
Commerzbank, Frankfurt
-  **Greece**  
Revithoussa LNG Tanks
-  **Hong Kong**  
Hong Kong International Airport  
Stone Cutter Bridge
-  **Indonesia**  
BDNI Commercial Towers
-  **Italy**  
Torre Telecomunicazioni Milano
-  **Malaysia**  
Petronas Twin Towers
-  **Mexico**  
ABC Hospital in Santa Fe,  
Mexico City
-  **Netherlands**  
Waalbrug A2 Zaltbommel  
Amsterdam Airport
-  **Nigeria**  
LNG tanks Bonny
-  **Norway**  
Troll Olje Platform  
Control Tower in Gardemoen  
International Airport, Oslo
-  **Portugal**  
Panoramic Tower Expo '98
-  **Qatar**  
LNG tanks Doha  
Doha International Airport
-  **South Africa**  
Lesotho Highlands Water  
Scheme Katse Intake Tower
-  **Spain**  
Puente del Alamillo  
Barcelona Olympic Stadium
-  **Sweden**  
Göta Tunnel, Gothenburg  
Aosta Bridge, Stockholm
-  **Switzerland**  
Wasserkraftwerk Wynau
-  **Turkey**  
Metro Istanbul
-  **United Arab Emirates**  
Burj Dubai
-  **United Kingdom**  
Canary Wharf, Channel Tunnel  
Terminal T5 Heathrow Airport
-  **United States**  
San Francisco Intl. Airport  
Venetian Hotel and Casino  
Olmstead Lock and Dam  
Trump Tower  
San Francisco Bay Bridge
-  **Venezuela**  
Macagua 5 II Dam & Power House

**nVENT LENTON TAPER THREADED MECHANICAL SPLICES ARE AS GOOD AS HAVING MONEY IN THE BANK!**

Consider the many benefits of mechanical splicing, cost over time is a lot less than expected.

- One of the fastest methods of splicing rebar
- Self centering and self aligning
- Helps eliminate construction delays due to rebar congestion challenges
- Helps accelerate construction schedules
- Enhances job site safety

# Your Choice of nVent LENTON Mechanical Splices Will Withstand the Test of Time

## PROVIDES CONTINUITY IN QUALITY AND STRENGTH

nVent LENTON taper threaded couplers are manufactured from high strength, high quality steel. All nVent LENTON design and manufacturing facilities are ISO<sup>SM</sup> 9001-2008 registered.

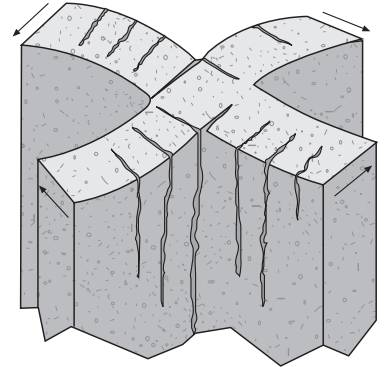

## WITHSTANDS THE TEST OF TIME

### SEISMIC CONSIDERATIONS

Lap splices may pull apart during seismic loads. nVent LENTON couplers offer more strength than lap splices during seismic, man-made blasts or other natural events as their performance is independent of surrounding concrete. nVent LENTON couplers exceed ACI<sup>®</sup>/IBC<sup>®</sup> Type 1 (125% of specified yield) & Type 2 (specified ultimate) splice requirements.

nVent LENTON splices provide you with the ability to design and build concrete structures that meet or exceed today's stringent construction codes and federal regulations regarding seismic frame construction. nVent LENTON couplers are superior to other current methods of splicing in withstanding seismic, man-made blasts and other natural events by providing reinforcing splices for rebar.

### TEST CONDUCTED TO ICC AC 133 PERFORMED ON TYPICAL U.S. REBAR

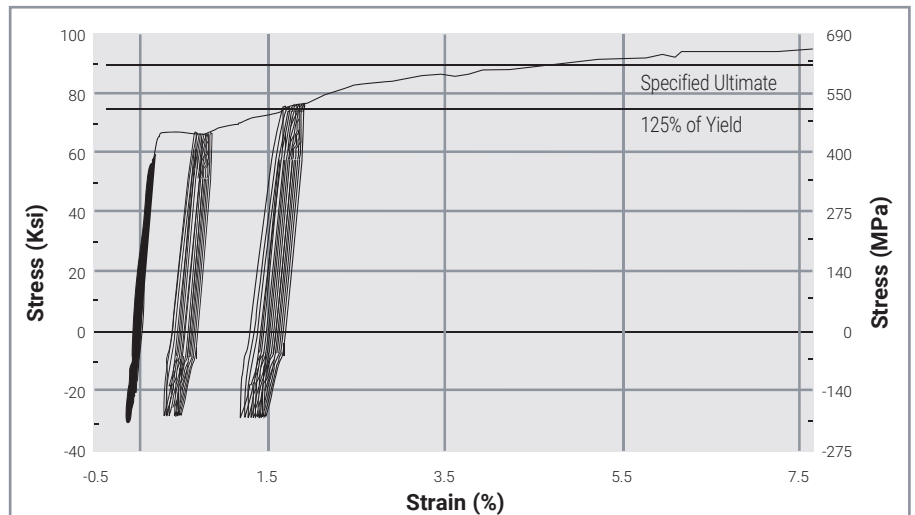

*nVent LENTON provides superior performance in cyclic reversal applications.*

# Withstand the Test of Time

## PROVIDES CONTINUITY IN PROJECT ECONOMICS

nVent LENTON reduces the amount of additional rebar that is required in a lap system. The system can be installed in a matter of seconds, with no special skills or bulky equipment required. Construction schedules can be accelerated to achieve optimum costs. The benefit-to-cost ratio using the nVent LENTON system is often superior to lap splicing.

## CORROSION CONSIDERATIONS

Corrosion increases the size of the rebar causing the concrete cover to spall and crack. As lap splices depend on the "bond" between concrete and steel for strength, concrete degradation caused by corrosion results in lap splice failure. With nVent LENTON couplers, structural integrity is maintained even with the loss of the concrete cover because mechanical couplers perform similar to a continuous piece of rebar.

## nVENT LENTON TAPER THREADED MECHANICAL REBAR SPLICING SYSTEM PROVIDES:

- A better way to design and build
- Continuity and structural integrity
- Compliance with international design codes
- Ease of installation
- Economy of design
- Many economic advantages
- Reduced shipping costs over other methods of splicing or anchoring
- Exceed ACI<sup>®</sup>/IBC<sup>®</sup> Type 1 (125% of specified yield) & Type 2 (specified ultimate) splice requirements

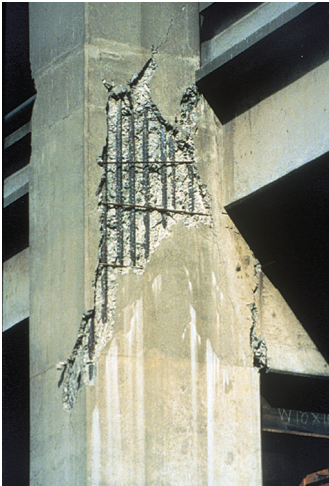

*Lap splices transfer their load through the concrete and will fail as concrete cover degrades.*

*nVent LENTON mechanical couplers perform similar to a continuous length of rebar regardless of concrete condition.*

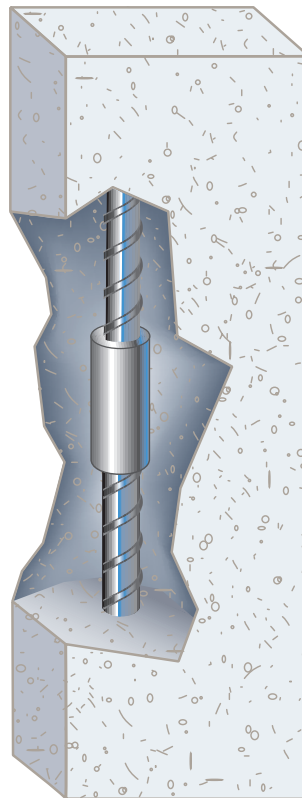

# Taper Threaded Mechanical Splicing System Applications

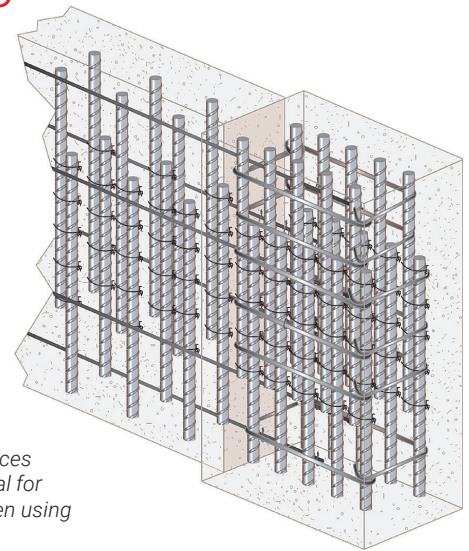

Lap splicing requires more rebar.

nVent LENTON mechanical splices reduce congestion, and are ideal for fast and easy rebar placing when using sliding or climbing formwork.

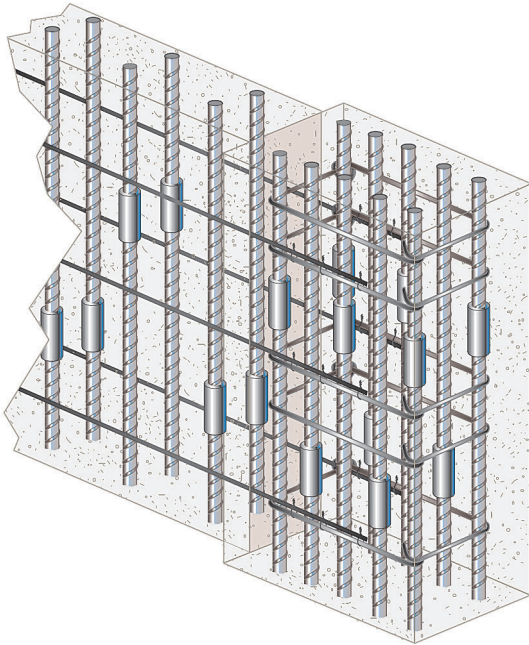

## Shear Wall

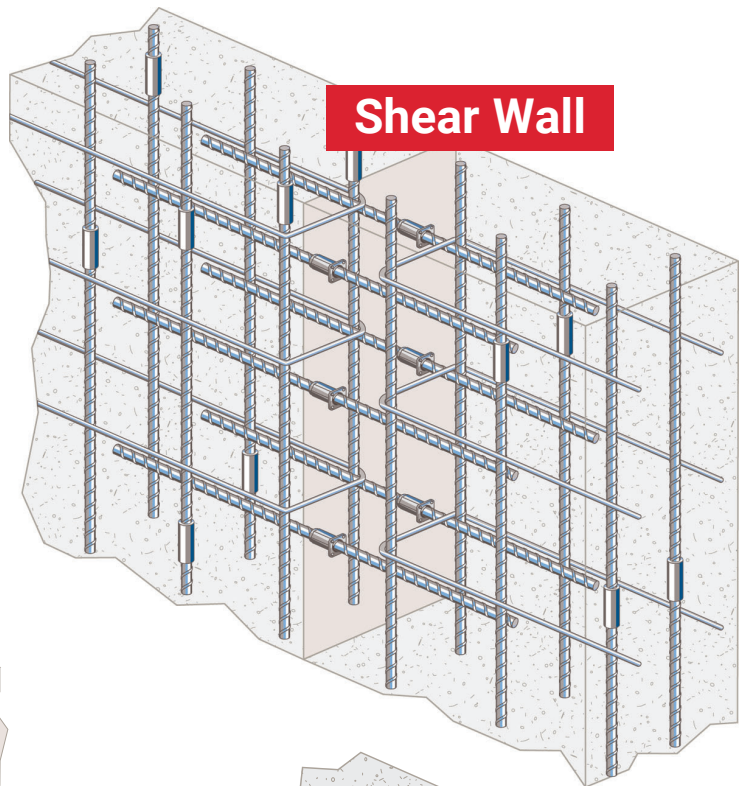

## Wall Slab

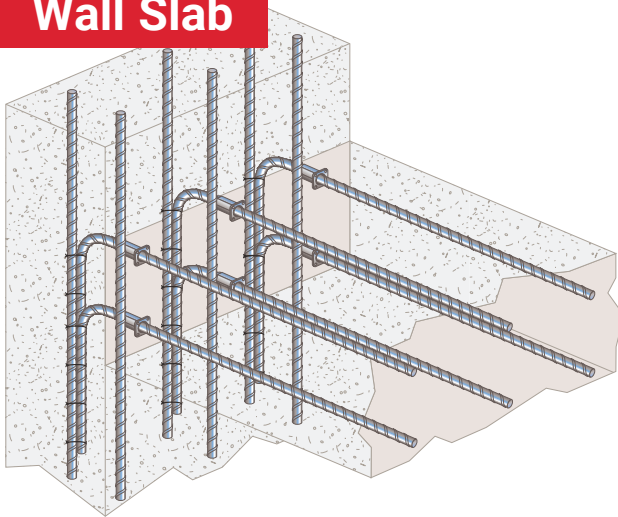

nVent LENTON Form Savers for wall/slab or wall/beam connections eliminate the need to penetrate the formwork. Indispensable when using sliding or climbing formwork.

## Future Extension

nVent LENTON Couplers are ideal for future extensions. All couplers are supplied with thread-protective plastic caps, which can be removed to expose the coupler when construction recommences. Heavy duty steel caps are available on request.

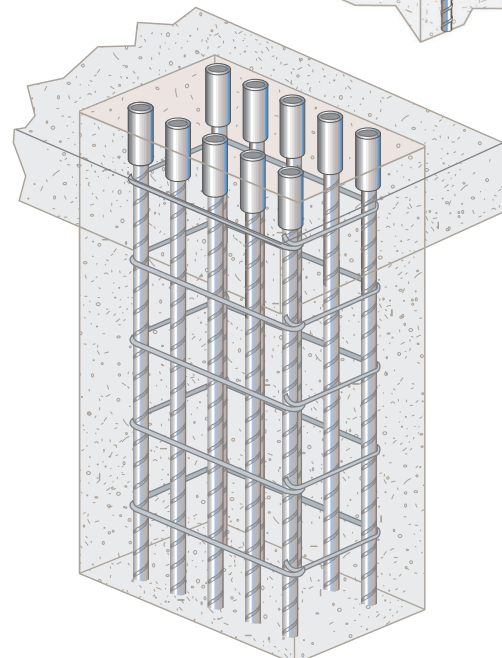



## Column

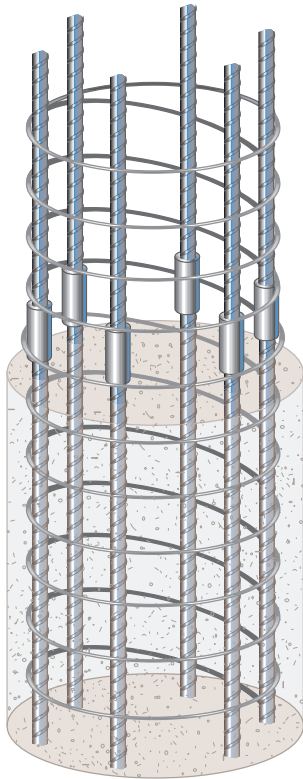

nVent LENTON mechanical splices

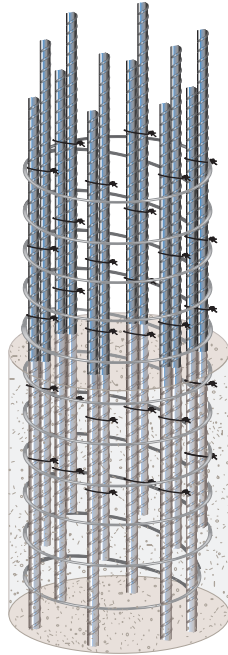

Lap splicing inhibits concrete consolidation

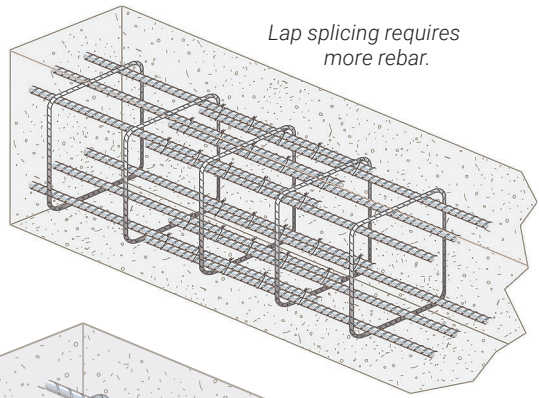

Lap splicing requires more rebar.

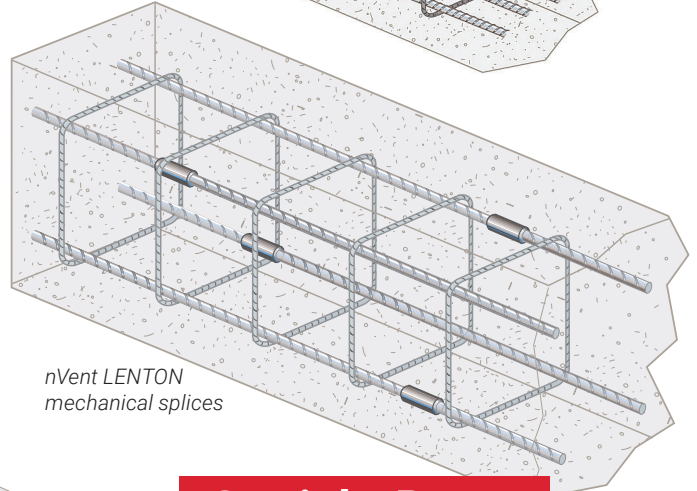

nVent LENTON mechanical splices

## Beam/Column

nVent LENTON Terminator is ideal for rebar anchorage applications to eliminate hooked rebar, reduce congestion and simplify bar placement.

## Straight Beam

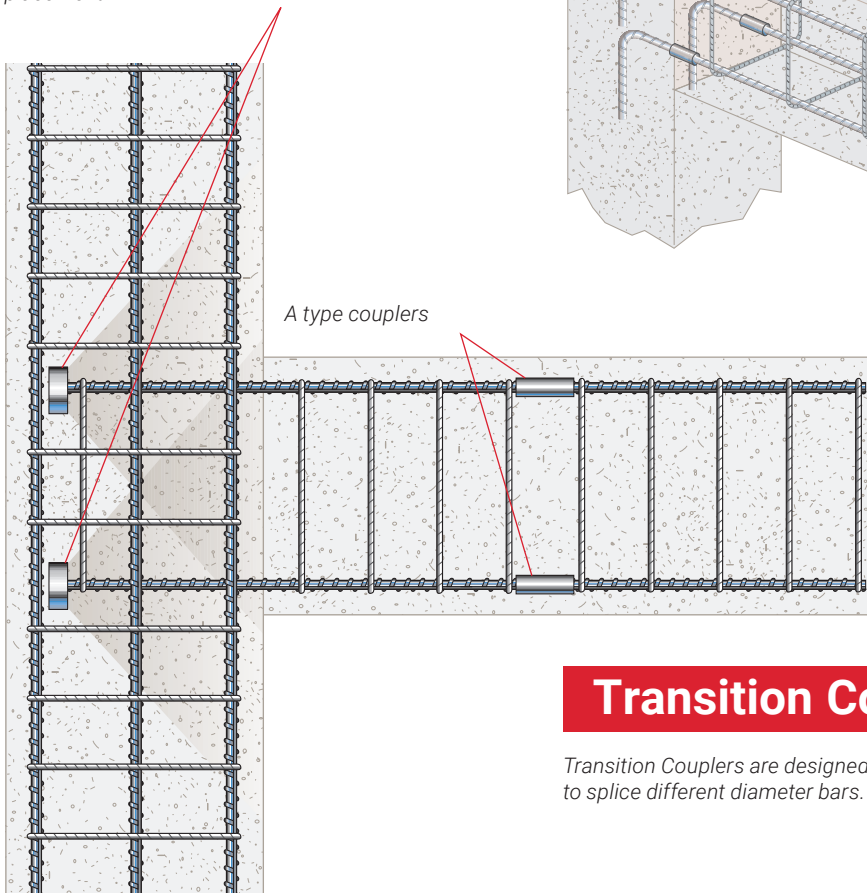
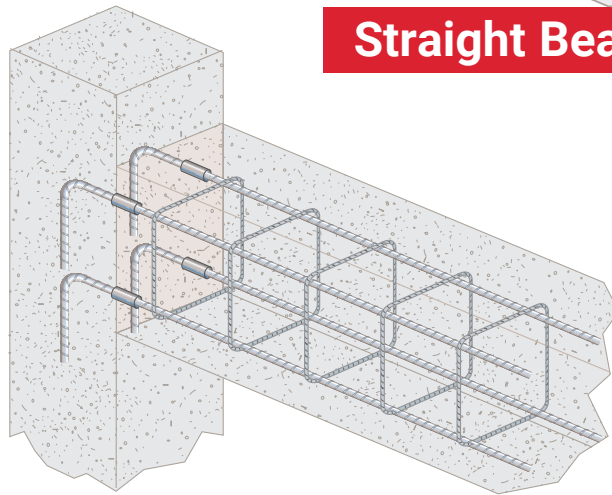

A type couplers

## Transition Coupler

Transition Couplers are designed to splice different diameter bars.

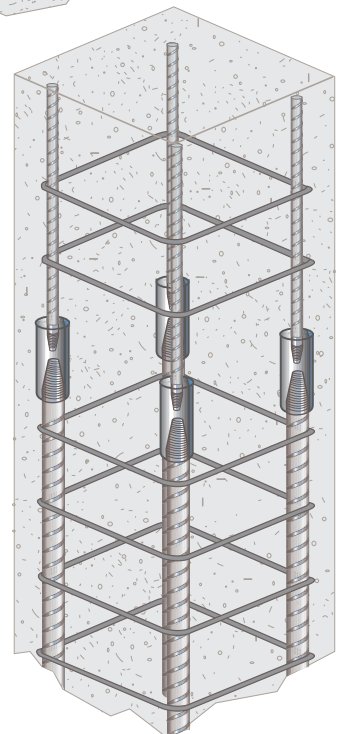

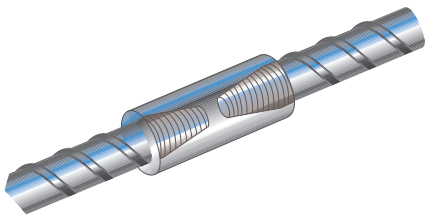

# nVent LENTON Standard Couplers

Standard couplers are designed to splice the same diameter bars where one bar can be rotated and the bar is not restricted in its axial direction.

Meets international standards, including BS EN 1992-1-1, DIN EN 1992-1-1, NFA-35-020, and ACI®318

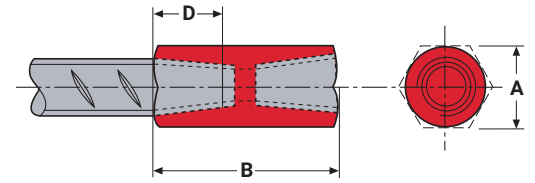

## STANDARD COUPLERS - A12

STANDARD IN EUROPE, ASIA AND AUSTRALIA\*\*

- A = diameter
- B = length of coupler bar
- D = bar engagement

Rebar Size Designation	Part No.	"A" mm	"B" mm	"D" mm	Weight kg
10	EL10A12	17*	49	18	0.07
12	EL12A12	17*	50	19	0.06
14	EL14A12	22*	56	21	0.13
16	EL16A12	22*	61	24	0.13
18	EL18A12	27*	72	29	0.25
20	EL20A12	27*	87	35	0.27
22	EL22A12	30*	91	37	0.35
25	EL25A12	35	97	40	0.44
28	EL28A12	40	101	42	0.61
30	EL30A12	40	121	52	0.69
32	EL32A12	45	108	45	0.79
34	EL34A12	45	128	55	0.89
36	EL36A12	50	121	52	1.08
38	EL38A12	55	124	53	1.41
40	EL40A12	55	131	57	1.40
43	EL43TA12	60	158	66	2.07
50	EL50TA12	70	166	70	2.91
57	EL57TA12	80	192	83	4.45

\* Use hex material (measured across the flats), others use round material.  
 \*\* Available in select regions in U.S.

Meets BS EN 1992-1-1, IBC®, AS3600, NEN-EN 1992-1-1, and ACI318

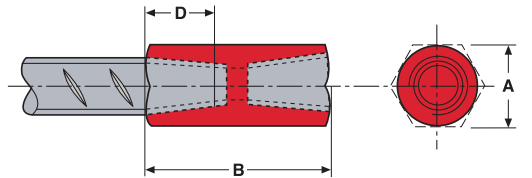

## STANDARD COUPLERS - A2

STANDARD IN THE AMERICAS, THE MIDDLE EAST, AFRICA AND ASIA

Inch	Rebar Size Designation			Part No.	"A"		"B"		"D"		Weight	
lb	Metric	Canadian	Soft Metric		in	mm	in	mm	in	mm	lb	kg
4	12 mm	10M	13	EL12A2*	11/16	17	1-5/8	41	9/16	14	0.1	0.05
5	16 mm	15M	16	EL16A2*	7/8	22	2-3/16	56	7/8	22	0.3	0.14
6	20 mm	20M	19	EL20A2*	1-1/16	27	2-13/16	71	1-1/8	29	0.5	0.23
7	22 mm	-	22	EL22A2*	1-3/16	30	3-5/32	80	1-1/4	32	0.7	0.32
8	25 mm	25M	25	EL25A2	1-3/8	35	3-11/32	85	1-3/8	35	0.9	0.41
9	28 mm	30M	29	EL28A2	1-1/2	38	3-19/32	91	1-1/2	38	1.1	0.50
10	32 mm	-	32	EL32A2	1-3/4	44	3-25/32	96	1-9/16	40	1.5	0.68
11	36 mm	35M	36	EL36A2	1-7/8	48	3-31/32	101	1-11/16	43	1.7	0.77
-	40 mm	-	-	EL40A2	2-3/16	52	4-15/16	125	2-3/16	56	2.4	1.07
14	43 mm	45M	43	EL43TA2	2-1/4	57	5-1/4	133	2-3/16	56	3.3	1.50
-	50 mm	-	-	EL50TA2	2-9/16	64	6-13/32	163	2-3/4	70	6.2	2.80
18	57 mm	55M	57	EL57TA2	3	76	6-15/32	164	2-13/16	71	7.3	3.31

\*Use hex material (measured across the flats), others use round material.

Bar dimensions and weights listed may vary by region. Coupler sizes not shown on these pages are available by special order. Contact your nVent representative for more information on special sizes. Article numbers used in Europe, Middle East, Africa and Asia exclusively.

# nVent LENTON Transition Couplers

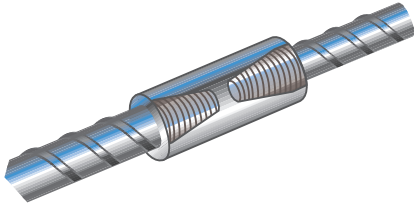

Transition couplers are designed to splice different diameter bars where one bar can be rotated and the bar is not restricted in its axial direction.

Meets international standards, including BS EN 1992-1-1, DIN EN 1992-1-1, NFA-35-020, and ACI®318

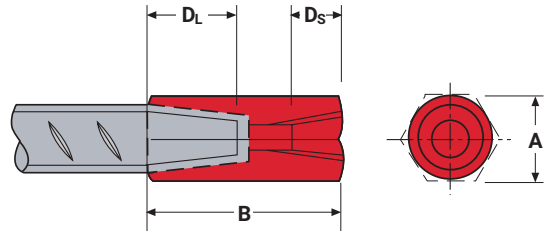

## TRANSITION COUPLERS - A12

STANDARD IN EUROPE, THE MIDDLE EAST, AFRICA, ASIA AND AUSTRALIA

- A** = coupler diameter
- B** = length of coupler bar
- DL** = large bar engagement
- DS** = small bar engagement

Rebar Size Designation mm	Part No.	"A" mm	"B" mm	"DL" Large Bar mm	"DS" Small Bar mm	Weight kg
16 - 12	EL1612A12	22*	61	24	19	0.14
16 - 14	EL1614A12	22*	64	24	21	0.14
20 - 16	EL2016A12	27*	80	35	24	0.27
22 - 20	EL2220A12	30*	95	37	35	0.38
25 - 20	EL2520A12	35	98	40	35	0.50
25 - 22	EL2522A12	35	100	40	37	0.49
28 - 20	EL2820A12	40	101	42	35	0.69
28 - 25	EL2825A12	40	105	42	40	0.67
32 - 25	EL3225A12	45	109	45	40	0.91
32 - 28	EL3228A12	45	111	45	42	0.88
36 - 32	EL3632A12	50	120	52	45	1.15
40 - 32	EL4032A12	55	126	57	45	1.50
43 - 40	EL43T40A12	60	152	66	57	2.07
50 - 32	EL50T32A12	70	147	70	45	3.00

\*Use hex material (measured across the flats), others use round material.

Meets BS EN 1992-1-1, IBC®, AS3600, and ACI318

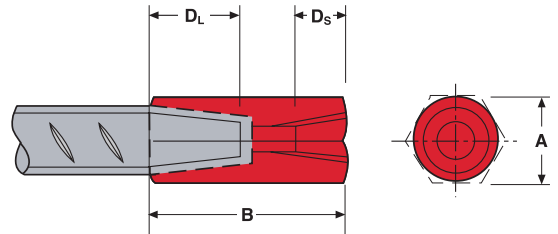

## TRANSITION COUPLERS - A2

STANDARD IN THE AMERICAS, ASIA AND AUSTRALIA

Rebar Size Designation				"A"	"B"	"DL" Large Bar	"DS" Small Bar	Weight						
Inch	lb	Metric	Canadian	Soft Metric	Part No.	in	mm	in	mm	in	mm	lb	kg	
5/4	16/12	15M/10M	16/13	EL1612A2	7/8	22*	2-5/16	59	7/8	22	9/16	14	0.3	0.15
6/5	20/16	20M/15M	19/16	EL2016A2	1-1/16	27*	3	76	1-1/8	29	7/8	22	0.7	0.31
7/6	22/20	-	22/19	EL2220A2	1-3/16	30*	3-13/16	97	1-1/4	32	1-1/8	29	0.8	0.36
8/7	25/22	-	25/22	EL2522A2	1-3/8	35	3-11/16	94	1-3/8	35	1-1/4	32	1.0	0.45
9/8	28/25	30M/25M	29/25	EL2825A2	1-1/2	38	3-29/32	99	1-1/2	38	1-3/8	35	1.3	0.59
10/9	32/28	-	32/29	EL3228A2	1-3/4	44	4-1/8	105	1-9/16	40	1-1/2	38	1.8	0.82
11/10	36/32	-	36/32	EL3632A2	1-7/8	48	4-5/16	110	1-11/16	43	1-9/16	40	2.1	0.95
14/11	43/36	45M/35M	43/36	EL43T36A2	2-1/4	57	5-3/32	129	2-3/16	56	1-11/16	43	3.6	1.63
18/11	57/36	55M/35M	57/36	EL57T36A2	3	76	5-11/32	136	2-13/16	71	1-11/16	43	7.5	3.40
18/14	57/43	55M/45M	57/43	EL57T43TA2	3	76	6-5/8	168	2-13/16	71	2-1/8	56	8.2	3.72

\*Use hex material (measured across the flats), others use round material.

Bar dimensions and weights listed may vary by region. Coupler sizes not shown on these pages are available by special order. Contact your nVent representative for more information on special sizes. Article numbers used in Europe, Middle East, Africa and Asia exclusively.

All items listed above are domestic steel, other non domestic steel may be available in USA. Contact nVent for pricing and availability.

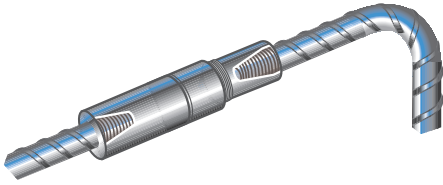

# nVent LENTON Position Couplers

P8 and P13 style couplers are designed to quickly splice two curved, bent, or straight bars, when neither bar can be rotated, and where the ongoing bar is restricted in its axial direction. Typical applications for these couplers are for the splicing of prefabricated cages.

The P13 position coupler can be supplied in two pieces for application against form work. The female parallel thread is corrosion protected with a plastic screw-in protection cap.

**A** = diameter

**B** = length of coupler body

**D** = bar engagement

**Fc** = connector and jam nut (closed position) length

**Max. Fo** = connector and jam nut (fully open position) length

Meets international standards, including BS EN 1992-1-1, DIN EN 1992-1-1, NFA-35-020, and ACI®318

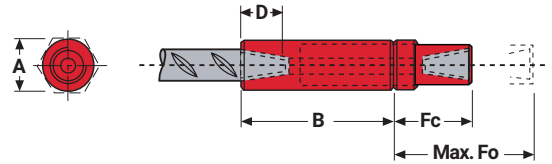

## POSITION COUPLERS - P13L

STANDARD IN EUROPE, THE MIDDLE EAST, AFRICA, ASIA AND AUSTRALIA

Rebar Size Designation mm	Part No.	"A" mm	"B" mm	"Fc" mm	Max. Fo	"D" mm	Weight kg
10	EL10P13L	25	70	50	85	18	0.36
12	EL12P13L	25	75	49	85	19	0.36
14	EL14P13L	25	82	51	90	21	0.37
16	EL16P13L	30	88	56	97	24	0.59
18	EL18P13L	35	100	61	107	29	0.85
20	EL20P13L	35	125	73	135	35	1.09
22	EL22P13L	40	132	77	141	37	1.55
25	EL25P13L	45	140	80	146	40	1.94
28	EL28P13L	50	147	83	151	42	2.53
30	EL30P13L	55	169	93	171	52	3.35
32	EL32P13L	60	156	93	164	45	3.96
34	EL34P13L	60	177	103	184	55	4.28
36	EL36P13L	65	172	99	177	52	5.01
38	EL38P13L	70	174	103	183	53	6.05
40	EL40P13L	70	184	106	190	57	6.18
43	EL43TP13L	75	213	127	219	66	8.24
50	EL50TP13L	90	224	135	230	70	11.71
57	EL57TP13L	100	256	148	257	83	17.11

\*Use hex material (measured across the flats), others use round material.

Meets BS EN 1992-1-1, IBC®, AS3600, and ACI318

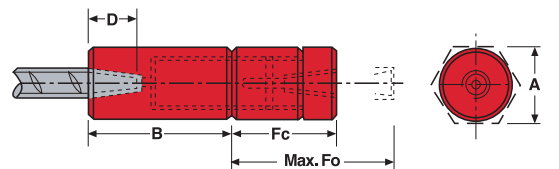

## POSITION COUPLERS - P8\*

DESIGN STANDARD IN AMERICA, AVAILABLE AS SPECIAL ORDER

Inch lb	Rebar Size Designation				"A" in	"B" in	"Fc" in	Max. Fo in	"D" in	Weight						
	Metric	Canadian	Soft Metric	Part No.						mm	kg					
5	16 mm	15M	16	EL16P8	1-13/16	46	3-17/32	89	1-19/32	40	3-5/32	81	7/8	22	1.1	0.50
6	20 mm	20M	19	EL20P8	1-13/16	46	4-1/4	108	1-19/32	40	3-9/16	91	1-1/8	29	1.9	0.86
7	22 mm	-	22	EL22P8	1-13/16	46	4-23/32	120	1-19/32	40	3-3/4	95	1-1/4	32	2.7	1.21
8	25 mm	25M	25	EL25P8	1-13/16	46	5-1/8	130	1-19/32	40	3-27/32	97	1-3/8	35	2.9	1.31
9	28 mm	30M	29	EL28P8	2-1/2	64	5-9/32	134	1-19/32	40	3-31/32	101	1-1/2	38	3.8	1.74
10	32 mm	-	32	EL32P8	2-1/2	64	5-23/32	145	1-19/32	40	4-1/16	103	1-9/16	40	5.3	2.38
11	36 mm	35M	36	EL36P8	2-1/2	64	6-7/32	158	1-19/32	40	4-5/32	106	1-11/16	43	8.1	3.69
14	43 mm	45M	43	EL43TP8	3	76	7-25/32	198	3-29/32	99	7-9/32	185	2-3/16	56	18.0	8.18
18	57 mm	55M	57	EL57TP8	4	102	9-17/32	242	4-7/16	113	8-1/2	215	2-13/16	71	37.9	17.20

\*Contact nVent for lead time and availability.

Bar dimensions and weights listed may vary by region. Coupler sizes not shown on these pages are available by special order. Contact your nVent representative for more information on special sizes. Article numbers used in Europe, Middle East, Africa and Asia exclusively.

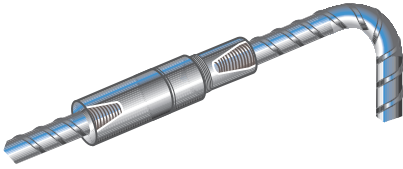

# nVent LENTON Position Couplers

The P9 and P14 style couplers are designed to splice two curved, bent or straight bars, when neither bar can be rotated and where the on-going bar is free to move in its axial direction. Typical applications for these couplers are for the splicing of pile cages.

The P14 Position coupler can be supplied in two pieces for application against form work. The female parallel thread is corrosion protected and is provided with a plastic screw-in protection cap.

**A** = diameter

**B** = length of coupler body

**D** = bar engagement

**Fc** = connector and jam nut (closed position) length

**Max. Fo** = connector and jam nut (fully open position) length

Meets international standards, including BS EN 1992-1-1, DIN EN 1992-1-1, NFA-35-020, and ACI®318

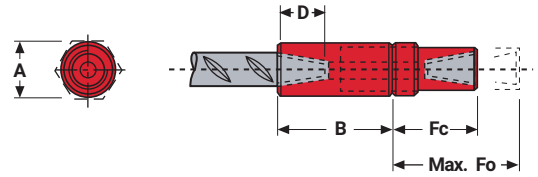

## POSITION COUPLERS - P14L

STANDARD IN EUROPE, THE MIDDLE EAST, AFRICA, ASIA AND AUSTRALIA

Rebar Size Designation mm	Part No.	"A" mm	"B" mm	"Fc" mm	Max. Fo	"D" mm	Weight kg
10	EL10P14L	25	42	52	59	18	0.27
12	EL12P14L	25	46	51	58	19	0.26
14	EL14P14L	25	51	54	60	21	0.26
16	EL16P14L	30	54	58	64	24	0.44
18	EL18P14L	35	61	63	70	29	0.58
20	EL20P14L	35	76	76	88	35	0.76
22	EL22P14L	40	80	80	92	37	1.09
25	EL25P14L	45	86	83	94	40	1.32
28	EL28P14L	50	90	85	97	42	1.72
30	EL30P14L	55	102	96	107	52	2.19
32	EL32P14L	60	96	96	107	45	2.72
34	EL34P14L	60	107	105	117	55	2.83
36	EL36P14L	65	105	102	113	52	3.37
38	EL38P14L	70	106	106	117	53	4.12
40	EL40P14L	70	112	109	120	57	4.14
43	EL43TP14L	75	142	132	152	66	5.99
50	EL50TP14L	90	148	139	160	70	8.52
57	EL57TP14L	100	167	153	173	83	12.05

Meets BS EN 1992-1-1, IBC®, AS3600, and ACI318

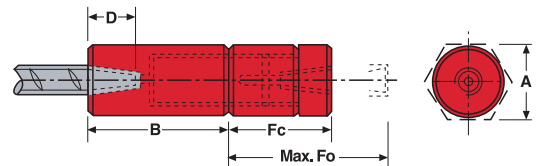

## POSITION COUPLERS - P9

STANDARD IN THE AMERICAS

Inch	Rebar Size Designation			Part No.	"A"		"B"		"Fc"		Max. Fo		"D"		Weight	
	Metric	Canadian	Soft Metric		in	mm	in	mm	in	mm	in	mm	in	mm	lb	kg
4	12 mm	10M	13	EL12P14L	1	25	1-13/16	46	1-5/8	42	2-1/16	53	3/4	19	0.6	0.26
5	16 mm	15M	16	EL16P14L	1-3/8	35	2-1/8	54	1-7/8	48	2-5/16	59	15/16	24	1.0	0.44
6	20 mm	20M	19	EL20P9	1-13/16	46	2-3/4	70	1-5/8	41	2-1/8	54	1-1/8	29	2.7	1.22
7	22 mm	-	22	EL22P9	1-13/16	46	3-1/16	78	1-5/8	41	2-1/8	54	1-1/4	32	2.7	1.22
8	25 mm	25M	25	EL25P9	1-13/16	46	3-3/8	86	1-5/8	41	2-1/8	54	1-3/8	35	2.8	1.27
9	28 mm	30M	29	EL28P9	2-1/2	64	3-9/16	90	1-5/8	41	2-1/8	54	1-1/2	38	6.0	2.73
10	32 mm	-	32	EL32P9	2-1/2	64	3-13/16	97	1-5/8	41	2-1/8	54	1-9/16	40	5.9	2.68
11	36 mm	35M	36	EL36P9	2-1/2	64	4-3/16	106	1-5/8	41	2-1/8	54	1-11/16	43	6.0	2.73
14	43 mm	45M	43	EL43TP9	3	76	5	127	3-13/16	97	4-5/8	117	2-3/16	56	12.4	5.64
18	57 mm	55M	57	EL57TP9	4	95	6-1/8	156	4-3/8	111	5-3/16	132	2-13/16	71	25.0	11.36

\*Use hex material (measured across the flats), others use round material.

Bar dimensions and weights listed may vary by region. Coupler sizes not shown on these pages are available by special order. Contact your nVent representative for more information on special sizes. Article numbers used in Europe, Middle East, Africa and Asia exclusively.

All items listed above are domestic steel, other non domestic steel may be available in USA. Contact nVent for pricing and availability.

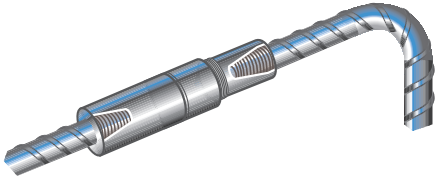

# nVent LENTON Position & Bolt Couplers

Meets international standards, including BS EN 1992-1-1, DIN EN 1992-1-1, NFA-35-020, and ACI®318.

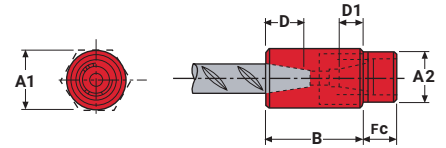

P15 position couplers are designed to quickly splice column sections or precision coupling of elements with multiple bars joined over a short span, such as prefabricated elements, and the closing of small temporary openings. Contact your local nVent representative for more information.

- A** = coupler diameter
- A1** = diameter
- A2** = diameter of connector end
- B** = length of coupler body
- C** = maximal bolt engagement
- D** = bar engagement
- D1** = bar engagement
- E** = full size metric thread
- F** = minimal bolt engagement
- Fc** = connector and jam nut

## POSITION COUPLERS - P15

STANDARD IN EUROPE, THE MIDDLE EAST AND AFRICA

Rebar Size Designation mm	Part No.	Art. No.	"A1" mm	"A2" mm	"B" mm	"Fc" mm	"D" mm	"D1" mm	Weight Kg
10	EL10P15	150540	27*	27*	40	19	18	11	0.31
12	EL12P15	150550	33	27*	42	19	19	13	0.36
14	EL14P15	150560	33	33	47	19	21	15	0.42
16	EL16P15	150570	37	33	52	19	24	17	0.51
18	EL18P15	150580	37	33	60	19	29	20	0.49
20	EL20P15	150590	41	37	69	24	35	22	0.72
22	EL22P15	150600	46	42	75	24	37	24	0.98
25	EL25P15	150610	52	42	81	24	40	29	1.26
28	EL28P15	150620	58	52	86	24	42	32	1.69
30	EL30P15	150630	58	52	100	24	52	36	1.92
32	EL32P15	150640	64	52	91	24	45	32	2.08
34	EL34P15	150650	64	58	106	24	55	37	2.43
36	EL36P15	150660	75	58	102	24	52	38	3.16
38	EL38P15	150670	75	64	105	24	53	38	3.16
40	EL40P15	150680	75	64	113	24	57	42	3.40
43	EL43TP15	150690	80	75	127	24	66	44	4.43
50	EL50TP15	150700	95	95	140	24	70	52	6.85
57	EL57TP15	150710	101	95	163	24	83	62	8.48

\*Use hex material (measured across the flats), others use round material.

Meets international standards, including BS EN 1992-1-1, DIN EN 1992-1-1, NFA-35-020, and ACI318.

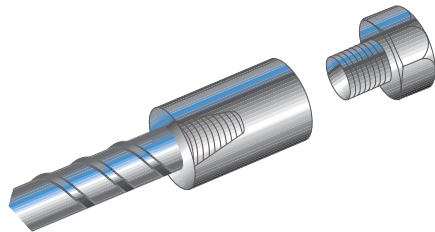
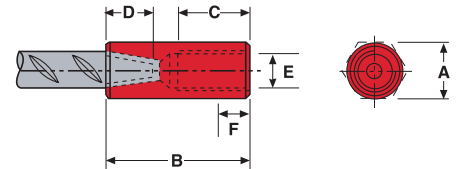

Bolt couplers provide a full strength joint between a reinforcing bar and a standard metric bolt. The coupler may be used for load-carrying steel structures bolted to concrete foundations, columns or walls, such as pylon bases, fixing crane rails, and fixings for heavy pipe work and walkways.

These couplers are machined from non-weldable grades of material, but can be tack welded. S13 can make a convenient transition from reinforcing bar to metric threaded stud, maintaining the full strength of the bar. Transition is useful when forming long tie-bars, such as in formwork or pile-planks, against internal pressure and to form a restraint anchor for ground anchors.

## BOLT COUPLERS - S13

STANDARD IN EUROPE, THE MIDDLE EAST, AFRICA, ASIA AND AUSTRALIA

Rebar Size Designation mm	Part No.	"A" mm	"B" mm	"C" mm	"D" mm	"E" mm	"F" mm	Weight kg
10	EL10S13	17*	53	28	18	M12	14	0.07
12	EL12S13	22*	58	33	19	M16	19	0.12
14	EL14S13	22*	63	35	21	M18	21	0.21
16	EL16S13	27*	68	37	24	M20	23	0.24
18	EL18S13	35	75	39	29	M22	25	0.28
20	EL20S13	35	98	55	35	M24	27	0.44
22	EL22S13	40	104	58	37	M27	31	0.87
25	EL25S13	45	110	61	40	M30	33	0.81
28	EL28S13	50	115	64	42	M33	37	0.93
30	EL30S13	55	128	67	52	M36	40	1.16
32	EL32S13	55	125	70	45	M39	43	1.51
34	EL34S13	55	135	70	55	M39	43	1.58
36	EL36S13	65	134	73	52	M42	46	2.05
38	EL38S13	65	139	77	53	M45	49	1.94
40	EL40S13	65	143	77	57	M45	49	1.93
43	EL43TS13	75	163	84	66	M52	56	3.51
50	EL50TS13	85	171	88	70	M56	60	5.08
57	EL57TS13	95	192	96	83	M64	68	6.33

\*Use hex material (measured across the flats), others use round material.

**NOTE: S13 is supplied without bolt.**

S4 & S5 couplers are available in North America to transition from rebar to UNC & NC threads. Contact nVent for availability & dimensions. See [nVent.com/ERICO](http://nVent.com/ERICO) for more information.

# nVent LENTON Weldable Couplers

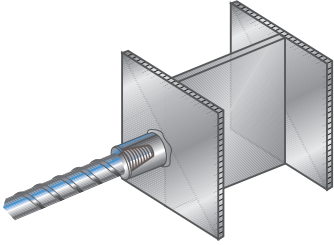

Weldable couplers provide a quick and easy solution for connecting reinforcing bar to structural steel sections or plates. Similar to the standard coupler, the weldable coupler is internally taper threaded on one end, with the other end prepared for welding.

These couplers are machined from weldable grades of material such as A.I.S.I. 1018, 1030, 1035 or St 52.5, depending on rebar size. The couplers are usually arc welded to the structural steel in a fabricating shop. The design of the weld, the selection of electrode, and other relevant choices depend on the chemical and physical properties of the structural steel to which the couplers are welded.

Engineers who design assemblies should adhere to all appropriate regulations.

- A** = coupler diameter
- B** = length of coupler body
- D** = bar engagement
- G** = small diameter

Meets international standards, including BS EN 1992-1-1, DIN EN 1992-1-1, NFA-35-020, and ACI®318.

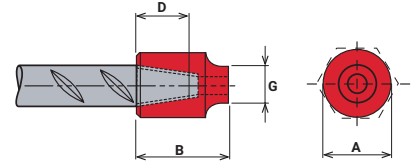

## WELDABLE COUPLERS - C12

STANDARD IN EUROPE, THE MIDDLE EAST, AFRICA, ASIA AND AUSTRALIA

Rebar Size Designation mm	Part No.	Art. No.	"A" mm	"B" mm	"D" mm	"G" mm	Weight kg
10	EL10C12	151080	20	30	18	12	0.06
12	EL12C12	151090	20	30	19	12	0.05
14	EL14C12	151100	25	35	21	13	0.09
16	EL16C12	151110	25	40	24	15	0.09
18	EL18C12	151120	30	45	29	16	0.16
20	EL20C12	151130	30	50	35	17	0.17
22	EL22C12	151140	40	55	37	18	0.35
25	EL25C12	151150	40	55	40	21	0.32
28	EL28C12	151160	40	55	42	24	0.29
30	EL30C12	151170	50	65	52	24	0.60
32	EL32C12	151180	50	60	45	28	0.52
34	EL34C12	151190	50	70	55	28	0.60
36	EL36C12	151200	60	65	52	31	0.83
38	EL38C12	151210	60	70	53	33	0.89
40	EL40C12	151220	60	75	57	34	0.92
43	EL43TC12	151230	75	85	66	36	1.26
50	EL50TC12	151240	75	90	70	43	1.73
57	EL57TC12	151250	90	100	83	47	2.76

Meets BS EN 1992-1-1, IBC®, AS3600, and ACI318

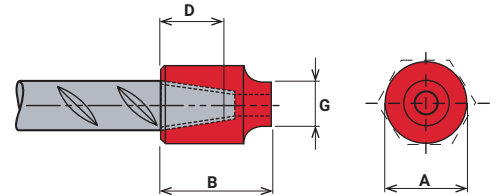

## WELDABLE COUPLERS - C2/C3J

STANDARD IN THE AMERICAS AND ASIA

Rebar Size Designation				"A"	"B"	"D"	"G"	Weight						
Inch	Metric	Canadian	Soft Metric	Part No.	in	mm	in	mm	in	mm	in	mm	lb	kg
4	12 mm	10M	13	EL12C2	3/4	19	1-3/16	30	9/16	14	7/16	11	0.1	0.05
5	16 mm	15M	16	EL16C2	1	25	1-3/8	35	7/8	22	9/16	14	0.2	0.09
6	20 mm	20M	19	EL20C3J	1-1/4	32	2-5/32	55	1-1/8	29	7/8	22	0.6	0.27
7	22 mm	-	22	EL22C3J	1-1/4	32	2-13/32	61	1-1/4	32	3/4	19	0.6	0.27
8	25 mm	25M	25	EL25C3J	1-9/16	40	2-17/32	64	1-3/8	35	1	25	0.9	0.41
9	28 mm	30M	29	EL28C3J	1-9/16	40	2-11/16	68	1-1/2	38	15/16	24	0.9	0.41
10	32 mm	-	32	EL32C3J	2	51	2-7/8	73	1-9/16	40	15/16	24	1.6	0.73
11	36 mm	35M	36	EL36C3J	2	51	2-31/32	75	1-11/16	43	1-1/8	29	1.6	0.73
-	40 mm	-	-	EL40C2	2-3/16	55	2-7/8	73	2-3/16	56	1-13/32	36	1.8	0.82
14	43 mm	45M	43	EL43TC3J	2-3/8	60	3-3/4	96	2-3/16	56	1-13/32	36	2.9	1.32
-	50 mm	-	-	EL50TC2	2-15/16	75	3-9/16	90	2-3/4	70	1-7/8	47	2.5	1.14
18	57 mm	55M	57	EL57TC3J	3-1/8	80	4-1/2	114	2-13/16	71	1-3/4	44	5.4	2.45

Bar dimensions and weights listed may vary by region. Coupler sizes not shown on these pages are available by special order. Contact your nVent representative for more information on special sizes. Article numbers used in Europe, Middle East, Africa and Asia exclusively.

Visit [nVent.com/ERICO](http://nVent.com/ERICO) for additional information.

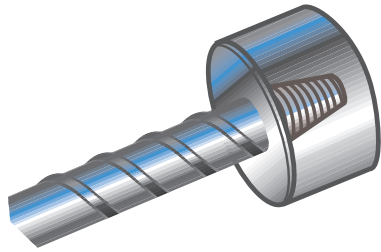

# nVent LENTON Mechanical Anchors

Meets international standards, including BS EN 1992-1-1, DIN EN 1992-1-1, NFA-35-020, ACI®318, and ASTM® A970.

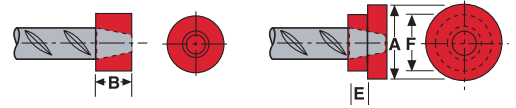

The nVent LENTON Terminator provides an alternative to hooked rebar, or an anchor or stop nut for rebar passing through a pile plank or structural steel element. The front face of the coupler is generously designed to carry the full tension load of the rebar when the anchor is bearing against concrete or structural steel.

The A2D6 Terminator (not shown) is threaded on both sides for future extension work and provides the same anchorage benefits as the D6 and D16. This coupler is available in North America only. Contact nVent for more information.

- A** = large diameter
- B** = length of coupler body/  
bar engagement
- E** = length of small step
- F** = small diameter

## TERMINATOR - D14

STANDARD IN THE AMERICAS\*, EUROPE, THE MIDDLE EAST AND AFRICA

Rebar Size Designation mm	Part No.	"A" mm	"B" mm	"E" mm	"F" mm	Weight Kg
10	EL10D14	35	18	-	-	0.13
12	EL12D14	45	18	-	-	0.22
14	EL14D14	45	21	-	-	0.25
16	EL16D14	55	24	-	-	0.42
18	EL18D14	60	29	-	-	0.61
20	EL20D14	65	35	-	-	0.84
22	EL22D14	70	37	-	-	1.04
25	EL25D14	80	40	-	-	1.45
28	EL28D14	95	42	25	80	1.76
30	EL30D14	95	52	25	80	2.26
32	EL32D14	105	45	25	80	2.14
34	EL34D14	110	55	25	80	2.94
36	EL36D14	115	52	25	80	2.84
38	EL38D14	120	53	25	80	3.12
40	EL40D14	130	58	26	58	3.41
43	EL43TD14	150	67	34	61	4.73
50	EL50TD14	160	71	33	77	6.38
57	EL57TD14	190	84	41	80	9.72

\*Available in select regions of U.S.

Meets BS EN 1992-1-1, IBC®, AS3600, ACI®318, and ASTM A970.

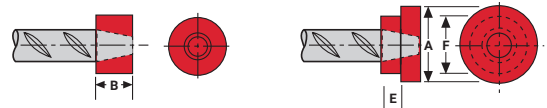

## TERMINATOR - D6

STANDARD IN THE AMERICAS, ASIA AND AUSTRALIA

Inch lb	Rebar Size Designation			Part No.	"A"		"B"		"E"		"F"		Weight	
	Metric	Canadian	Soft Metric		in	mm	in	mm	in	mm	in	mm	lb	kg
4	12 mm	10M	13	EL12D6	1-3/8	35	9/16	14	-	-	-	-	0.2	0.09
5	16 mm	15M	16	EL16D6	1-1/2	38	7/8	22	-	-	-	-	0.4	0.18
6	20 mm	20M	19	EL20D6	1-7/8	48	1-1/8	29	-	-	-	-	0.8	0.36
7	22 mm	-	22	EL22D6	2	51	1-1/4	32	-	-	-	-	1.0	0.45
8	25 mm	25M	25	EL25D6	2-1/4	57	1-3/8	35	-	-	-	-	1.3	0.59
9	28 mm	30M	29	EL28D6	2-3/4	70	1-1/2	38	-	-	-	-	2.2	1.00
10	32 mm	-	32	EL32D6	3	76	1-9/16	40	-	-	-	-	2.7	1.22
11	36 mm	35M	36	EL36D6	3-1/4	83	1-11/16	43	-	-	-	-	3.4	1.54
-	40 mm	-	-	EL40D6	3-3/4	95	2-1/2	64	1	25	3	76	5.5	2.49
14	43 mm	45M	43	EL43TD6	4	102	2-1/8	54	1	25	3	76	4.9	2.22
-	50 mm	-	-	EL50TD6	4-1/2	114	2-9/16	65	1	25	3	76	7.1	3.22
18	57 mm	55M	57	EL57TD6	5-1/8	130	2-3/4	70	1	25	3	76	9.8	4.45

**NOTE: Thread does not need to be flush with end of Terminator. Thread may be +/- 2 threads from backside of coupler.**

Diameter exceeds 5x bar area requirements of AC347 & ACI.

Bar dimensions and weights listed may vary by region. Coupler sizes not shown on these

pages are available by special order. Contact your nVent representative for more information on special sizes. Article numbers used in Europe, Middle East, Africa and Asia exclusively.



# nVent LENTON Mechanical Anchors



Meets international standards, including BS EN 1992-1-1, DIN EN 1992-1-1, NFA-35-020, ACI®318, and ASTM® A970.

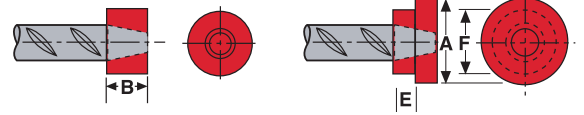

- A** = large diameter
- B** = length of coupler body/bar engagement
- E** = length of small step
- F** = small diameter

## TERMINATOR - D16

STANDARD IN THE AMERICAS\*, EUROPE, THE MIDDLE EAST AND AFRICA

Rebar Size Designation mm	Part No.	"A" mm	"B" mm	"E" mm	"F" mm	Weight Kg
10	EL10D16	22	18	-	-	0.13
12	EL12D16	28	19	-	-	0.13
14	EL14D16	31	22	-	-	0.14
16	EL16D16	36	24	-	-	0.16
18	EL18D16	40	30	-	-	0.32
20	EL20D16	45	35	-	-	0.37
22	EL22D16	50	38	-	-	0.49
25	EL25D16	57	40	-	-	0.76
28	EL28D16	64	42	-	-	0.93
30	EL30D16	67	52	-	-	1.35
32	EL32D16	72	46	-	-	1.34
34	EL34D16	76	56	-	-	1.87
36	EL36D16	81	52	25	75	1.73
38	EL38D16	85	54	25	75	1.74
40	EL40D16	89	58	25	80	2.14
43	EL43TD16	96	67	25	80	2.95
50	EL50TD16	112	71	25	80	3.82
57	EL57TD16	128	84	25	80	5.74

**NOTE: Thread does not need to be flush with end of Terminator. Thread may be +/- 2 threads from back of coupler.**

\* Available in select regions in U.S.

# nVent LENTON Equipment & Accessories

## INSPECTION WRENCH



While all nVent LENTON mechanical splices can be easily tightened with a standard pipe wrench in 4 to 4-1/2 turns, nVent also supplies adjustable inspection wrenches. This wrench can be used to both install couplers and inspect torque values after installation.

Our recommended inspection wrench is engineered to provide values of torque enabling you to achieve the best possible splice.

The inspection wrench is intended for use on ALL types and styles of nVent LENTON taper threaded couplers/products. This includes nVent LENTON Form Saver, Terminator, nVent LENTON Position Couplers and nVent LENTON Half Couplers.

## RECOMMENDED WRENCH SETTINGS

Bar Size mm	Bar Size #	Wrench Settings	
		ft lbs	Nm
10	3	30	40
12	4	30	40
14		60	80
16	5	90	120
18		110	150
20	6	130	180
22	7	160	220
25 (24-26)	8	200	270
28	9	200	270
30		200	300
32	10	200	300
34		200	300
36	11	200	300
38	12	200*	350
40		200*	350
43	14	200*	350
50		200*	350
57	18	200*	350

\*Americas only

Bar dimensions and weights listed may vary by region. Coupler sizes not shown on these pages are available by special order. Contact your nVent representative for more information on special sizes. Article numbers used in Europe, Middle East, Africa and Asia exclusively.

# nVent LENTON Equipment & Accessories

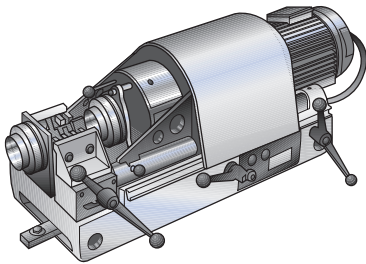

nVent LENTON bar threading machine  
EL-BT-101 Net weight 178 kg (392 lbs).  
Cutting oil capacity 14 liters (3.7 gal).

## STANDARD BAR THREADER

nVent LENTON bar threaders can be conveniently set up in a fabricator's shop or on site, allowing greater production control. Machines are available for rent from nVent worldwide. Training is provided by nVent instructors. Thread cutting chaser sets and cutting oil are consumables and must be purchased by the user.

Bar size Ø	(in-lb) mm	(#3-#5) 10-18	(#6-#9) 20-28	(#10-#14) 30-43	(#18) 50-57
<b>Bar threads per set of chasers (normal average)</b>		600	400	300	150
<b>Bar threads per liter cutting oil</b>		400	200	100	75
<b>Guide for threads per hour</b>		70/80	40/50	20/30	12/20

Contact nVent for further information on our different bar threaders.



## INTERNAL COUPLER PROTECTORS\*

- Protects threads from contamination, such as in future extension applications
- Can be easily removed in seconds
- Enables continuous connections with existing reinforcing bar already placed in concrete
- Convenient and cost effective



## BAR END PROTECTORS\*

- Protects bar end from contamination and damage
- Placed over bar end immediately after threading
- Inhibits the formation of rust when the bar is exposed to the elements

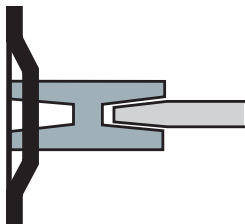

## FORM FIXERS

### (STANDARD IN EUROPE, THE MIDDLE EAST AND AFRICA)

Form fixers are nailing plates that are coupler dependent. These plates come in a variety of sizes and styles for connecting standard and position couplers to wood forms. The form fixer can be attached to the formwork before the anchor bar and coupler are fixed to it. All form fixers are easy to install and remove.

## EPOXY-COATED AND GALVANIZED NVENT LENTON MECHANICAL SPLICES

- All nVent LENTON standard and transition couplers, as well as Terminator are available in epoxy-coated, stainless and galvanized (special order only).
- nVent LENTON galvanized mechanical splices meet either ASTM® A767, B695 or B633 requirements, as applicable.
- nVent LENTON epoxy-coating complies with ASTM A775 and AASHTO® M284.
- Position couplers are also available in epoxy-coated (special order only).

**NOTE:** Coupler dimensions listed in this catalog may vary based on raw material supply.  
\*Refer to instruction sheets for additional information.

# A Look At nVent LENTON Concrete Reinforcement Products

nVent LENTON has been a pioneer in the concrete construction industry for more than 40 years. We changed rebar splicing, first with nVent ERICO Cadweld mechanical connections, then with the nVent LENTON mechanical splicing system – the #1 mechanical connector in the world. nVent LENTON now offers a wide range of mechanical splices for almost any construction need:



- **NVENT ERICO CADWELD** – Premiere mechanical splicing system
- **NVENT LENTON FORM SAVER** – Ideal for segmental pour
- **NVENT LENTON INTERLOK** – Ideal for precast structures
- **NVENT LENTON QUICK WEDGE** – Ideal for quick retrofit
- **NVENT LENTON SPEED SLEEVE** – Ideal for compression situations
- **NVENT LENTON TERMINATOR** – Ideal alternative to hooked rebar anchorage
- **NVENT LENTON LOCK** – Ideal for in-situ splices

The entire nVent LENTON line of mechanical rebar splices has replaced many conventional splicing systems, such as welding and lap splicing. Unlike butt welding, nVent LENTON products require no special training or external power source, are quicker to install and inspect, reduce crane time, improve the tensile strength of the splice and can be installed in any weather.

As your rebar splicing specialist, nVent LENTON offers you the expertise you need for all your rebar splicing projects.

## **NVENT LENTON TAPER THREADED MECHANICAL SPLICES:**

---

### **HOW TO ORDER**

To order the correct nVent LENTON mechanical splices for your construction applications, please call your local nVent office. Locations are listed on back cover.

### **HOW TO SPECIFY**

**Specific:** Mechanical connections shall be nVent LENTON taper threaded couplers as manufactured by nVent.

**Generic:** The mechanical connection shall meet building code requirements of developing in tension or compression, as required, by\*. The mechanical connection shall be the positive locking, taper threaded type coupler manufactured from high quality steel. The bar ends must be taper threaded using the manufacturer's bar threading equipment to ensure proper taper and thread engagement. Bars shall be installed to the manufacturer's requirements. The couplers shall be manufactured using registered quality systems around the world.

\*as required by local norms/codes.

*We reserve the right to make any alterations to the information contained in this brochure which we consider to be either necessary or advantageous. This brochure is designed to provide only preliminary information on the products and is not a contract. The Company does not accept any liability for loss or damage arising from failure to follow its instructions to products not agreed by it.*

Our powerful portfolio of brands:

**CADDY ERICO HOFFMAN RAYCHEM SCHROFF TRACER**



[nVent.com/LENTON](https://www.nvent.com/LENTON)

©2018 nVent. All nVent marks and logos are owned or licensed by nVent Services GmbH or its affiliates. All other trademarks are the property of their respective owners. nVent reserves the right to change specifications without notice.

LENTON-SB-CP7J-C72LT17WWEN-EN-1805