

CONNECT AND PROTECT

# nVent CADDY Speed Link

Universal Support System

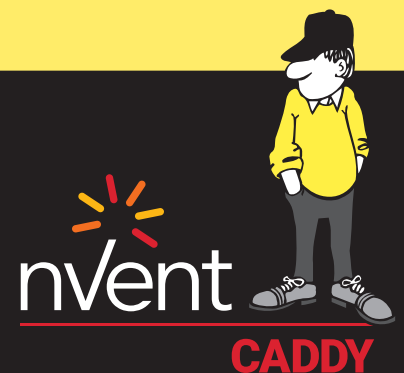

# HVAC

*applications*

Concrete Structure  
Attachments

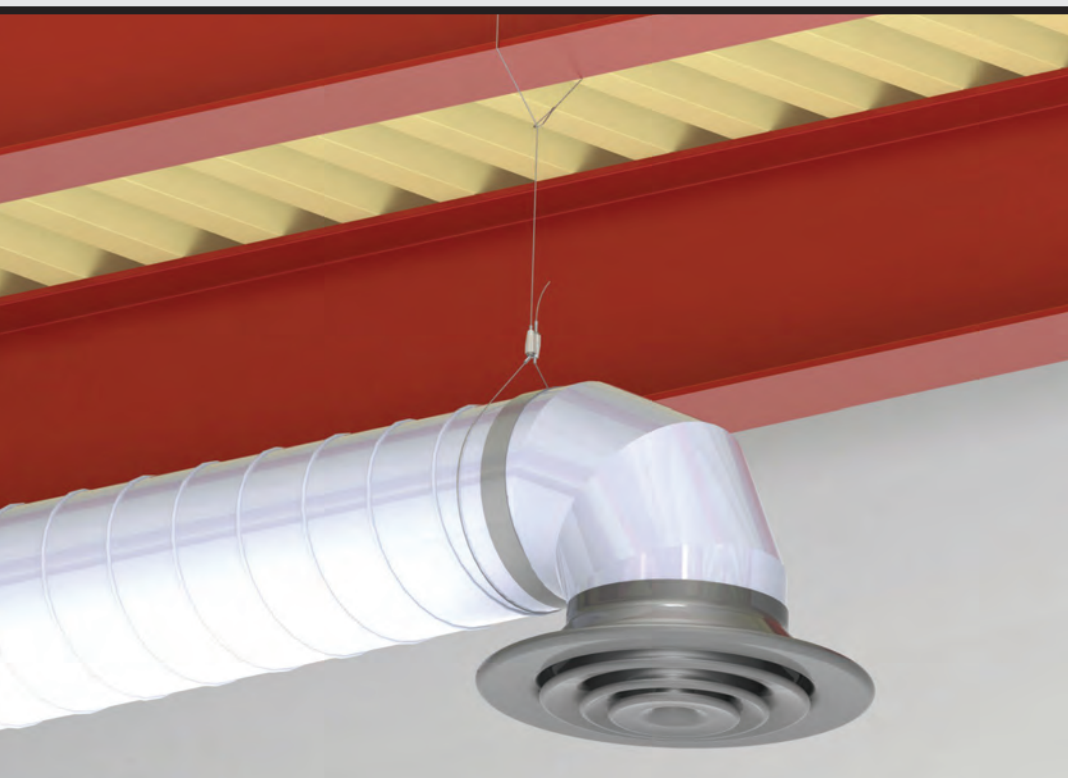

Hanging  
Solutions



# Steel Structure Attachments

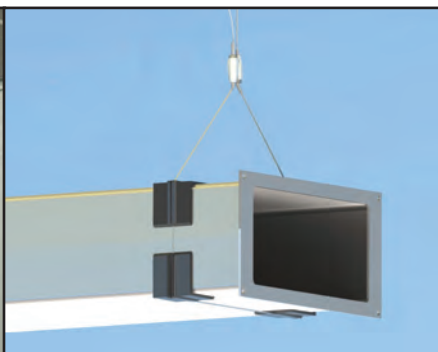
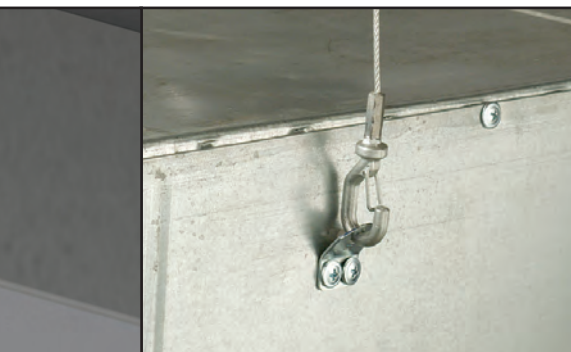
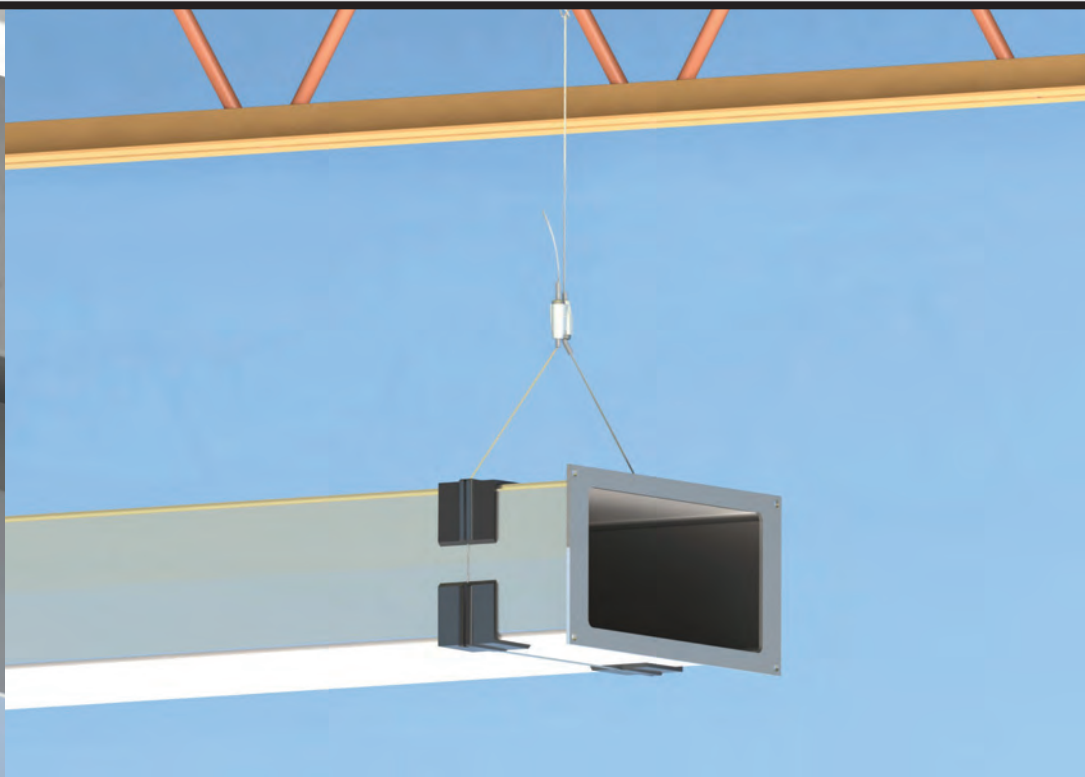
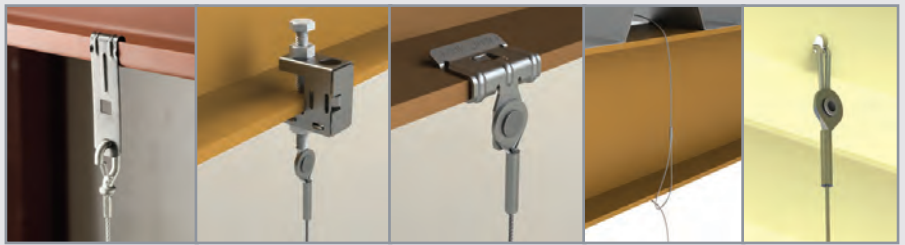

# Electrical

applications

Concrete Structure Attachments

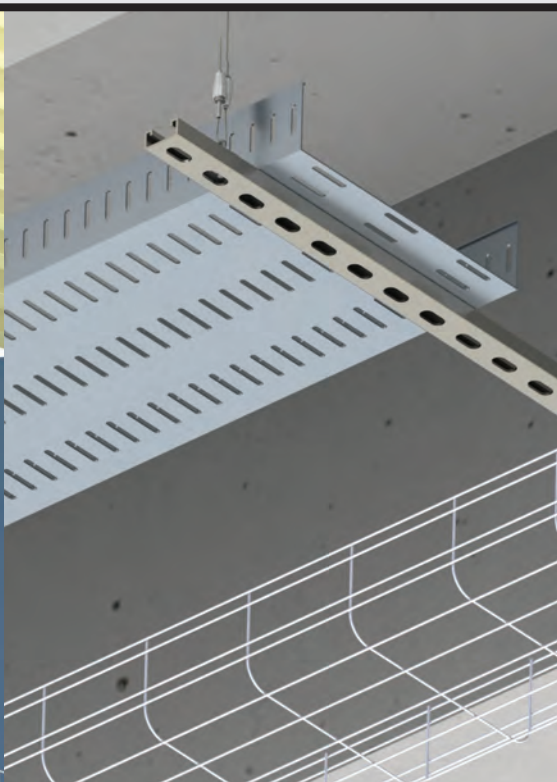
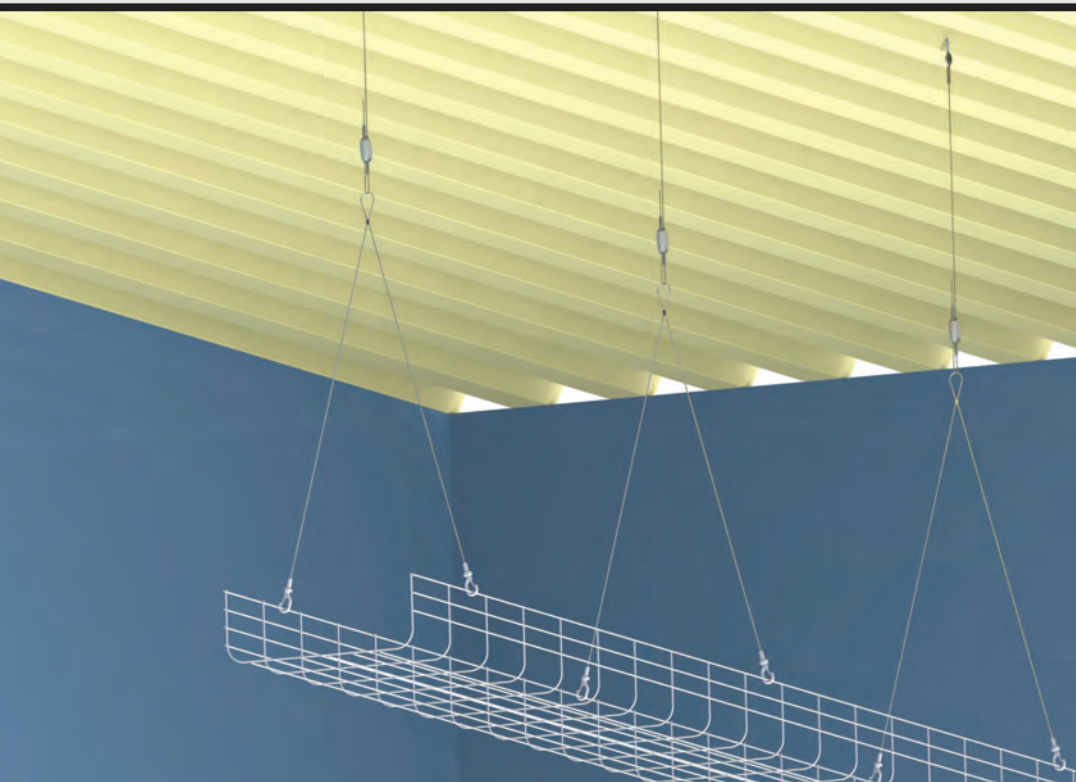

Hanging Solutions

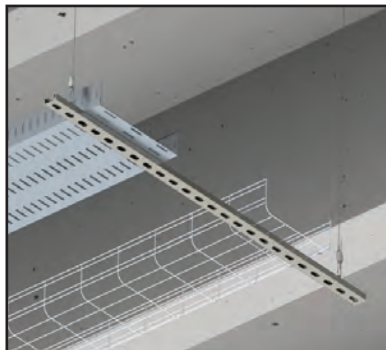

# & Datacom

## Steel Structure Attachments

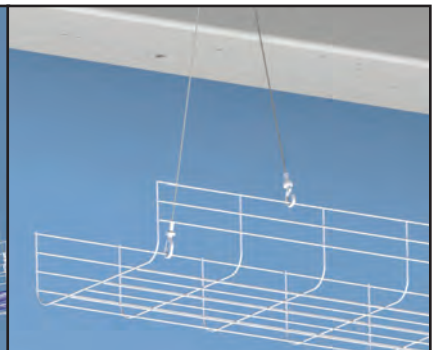
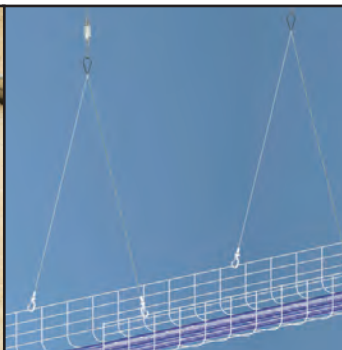
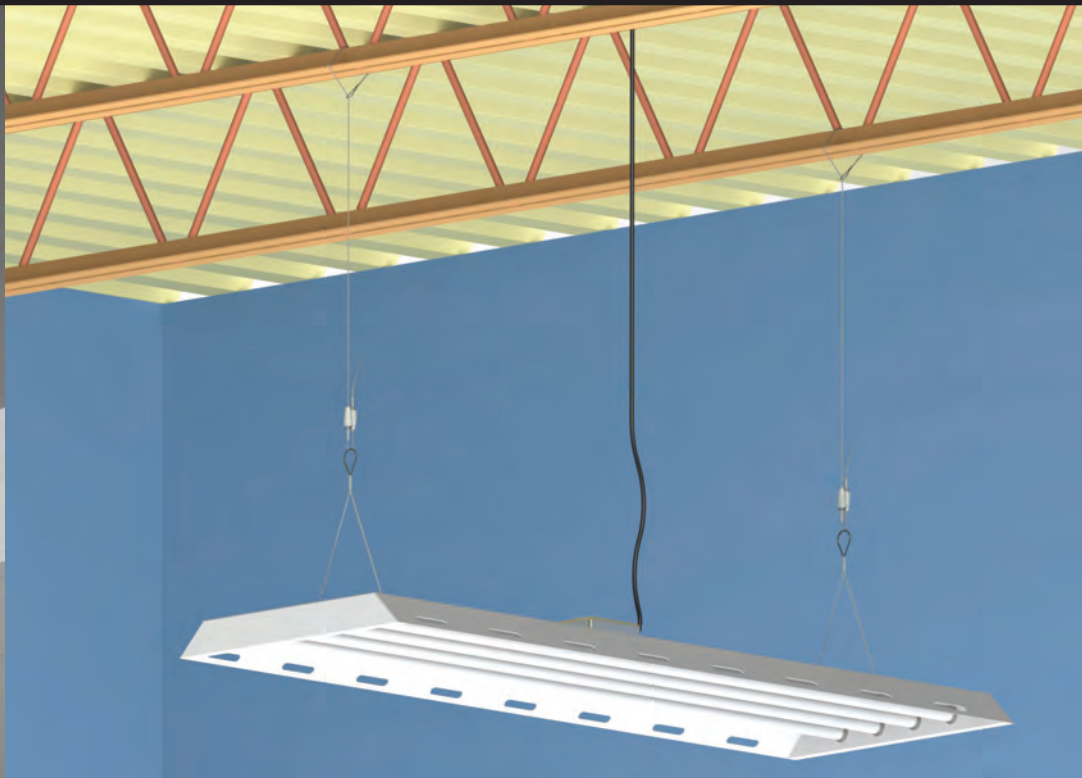
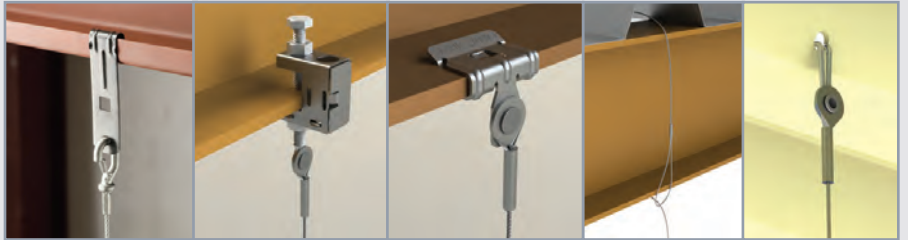

# WIRE ROPE SUPPORT SYSTEMS

AN EXAMINATION OF THE UNIQUE ADVANTAGES OF WIRE ROPE SUPPORT SYSTEMS IN MECHANICAL, ELECTRICAL AND DATACOM INSTALLATIONS.

## Benefits of a Wire Rope Support System



Cable support systems offer a unique combination of advantages that benefit almost any contracting project.

**CONTRACTORS USE WIRE ROPE SUPPORT SYSTEMS BECAUSE THEY ARE LIGHTWEIGHT, SAFE, EFFECTIVE AND EASY TO INSTALL. WHILE MOST COMPARABLE METHODS ARE DESIGNED FOR A SPECIFIC APPLICATION, WIRE ROPE SYSTEMS EXCEL IN FOUR KEY AREAS:**

**ADAPTABILITY:** Unlike other support systems, wire rope can be easily adapted to work with a variety of applications. The system appears very simple, but can be easily modified to hang rectangular duct, spiral duct, piping, basket tray, light fixtures and almost any other application that hangs from the ceiling. When cable supports are used for multiple applications on a jobsite, it greatly reduces the number of different products and tools that are needed, reduces waste, and simplifies purchasing.

**FLEXIBILITY:** Steel cable is incredibly flexible and allows for assemblies to be supported from a variety of angles. Unlike other methods that can be rigid and demand timely measurement, wire rope gives installers more slack when installing.

**SPEED:** Traditional support methods can make installing large assemblies very difficult. However, wire rope systems can be very quickly installed. Other hanging methods like jack chain, metal strap and threaded rod, need to be measured, cut, and installed using several tools. Wire rope systems are much easier to adjust and eliminate many of the time consuming tasks required for other installation methods.

**ADJUSTABILITY:** Installers can easily make fine adjustments with a wire rope support system by unlocking the wire from the locking device, moving the assembly and relocking the wire. Additionally, even load distribution between several supports can be easily and quickly checked by measuring cable tension the same way a contractor would measure tension on a V-Belt.

# nVent CADDY Speed Link SLK Locking Device

## WHY CHOOSE THE SLK?

### MARKET CONDITIONS

With so many wire rope support systems on the market, it can be difficult to identify the proper system to use in any situation. Wire rope systems are lightweight, flexible, adaptable, and easy to use, but it is also important to know which specific product is most effective.



### THE NVENT CADDY SOLUTION

The goal of the nVent CADDY development team is to provide the best products on the market. The Speed Link SLK locking device is designed to combine a unique collection of features to provide the most value to the end user. Specifically, there are three main features and three main applications that make the Speed Link SLK Locking Device different from any other wire rope support system on the market.

### FEATURES

**Double-Jaw:** The inside of the device has two jaws gripping the wire as opposed to the much more common single-cam device.



**Keyless Installation:** The device can be easily installed without keys or tools.

**Easily Used with Gloves:** The Release tube are big enough to be used while wearing gloves, unlike other smaller devices on the market.

### APPLICATIONS

The unique design of Speed Link SLK Locking Device allows for special applications:

#### Speed Link Competitive Advantages

Part Number	Application	Description	Competitor "G"	Competitor "Z"	Competitor "B"	Competitor "D"	Speed Link
	Splice	<ul style="list-style-type: none"> <li>Joining two pieces of wire</li> <li>Practical when working with wire spools or spool kits</li> </ul>	x	x*	x*	x	✓
	Infinite Loop	<ul style="list-style-type: none"> <li>Increased load rating</li> <li>Ideal when working with wire spools</li> <li>Only requires one locking device per drop</li> <li>Useful in tight spaces</li> </ul>	x	x*	x*	x	✓
	Low Level of Concealment	<ul style="list-style-type: none"> <li>Placing the locking device closer to the load makes it easier to hide</li> <li>The higher the maximum angle, the closer the device can be to the service</li> <li>Useful in tight spaces</li> </ul>	60°	?	39°	?	90°

\* Not specified on technical documents [but not advertized either]

? Not specified on technical documents but always shown with an angle lower than 90 degrees

# Speed Link Universal Support System

Speed Link is a universal support system designed to reduce installation time. A cost-effective alternative to jack chain, threaded rod, strut and strut nuts, this innovative system has the versatility to meet virtually all your support needs.

- Systems include locking device, wire rope, and specialty end fitting
- Strong, yet flexible, wire rope
- Selection of locking devices for different applications and load requirements
- Extensive range of end fittings for various types of structural attachments
- Allows objects to be hung at a variety of angles, even from sloped ceilings
- Works with an assortment of CADDY fasteners



**Speed Link  
Slk System** | **PAGES  
9-21**

Versatile wire rope system featuring keyless adjustment across a broad range of applications; ideal for hanging ductwork, pipe and tube, cable tray, lighting, conduit, strut profiles and signage.



**Speed Link  
Ld System** | **PAGE  
22**

Light duty wire rope system; ideal for hanging light-duty fixtures, ductwork, speakers, alarm sensors, signage and pipes in applications that require all stainless steel components for a greater corrosion resistance.



**Speed Link  
Sls System** | **PAGE  
23-29**

Versatile wire rope system that attaches directly to metal framing channels without the use of tools; ideal for hanging strut-based applications, ceiling fan units or cable tray.



**Speed Link  
Extensions** | **PAGE  
30-33**

Wire rope extensions with specialty end fittings to combine with other Speed Link systems.



**Speed Link Locking  
Devices And Wire Rope** | **PAGE  
34-37**

Kit includes spool of Speed Link steel wire and Speed Link SLK locking devices

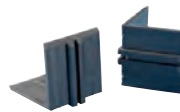

**Speed Link  
Accessories** | **PAGES  
38-41**

Accessories for Speed Link wire rope systems.



# Speed Link SLK Device

## SAFETY FEATURES

Keyless release tubes are designed to allow safe and easy adjustment, even while wearing bulky gloves

Two jaws grip the wire inside the device, holding the wire more securely than single-cam devices common among most competitors. This rare gripping mechanism allows it to be used in unique applications such as splicing/joining two wires, infinite loop etc.

UL Listing on all 11 end fittings for pre-cut lengths, SMACNA approved for hook and loop end fittings. Intertek Load Test report available upon request.

The color of the line corresponds to the larger goal of each feature:

## SAFETY FEATURES

## AESTHETICAL FEATURES

## EASE OF USE FEATURES

## AESTHETICAL FEATURES

Low-profile locking device provides a positive aesthetic to a finished project

## EASE OF USE FEATURES

Arrows on the device clearly demonstrate the correct direction to push the wire

Speed Link is lighter, faster to install, easier to transport and generates less waste than alternative hanging methods

Available in pre-cut lengths with 11 end-fittings or in bulk with spools of wire to adapt to the end-users' needs and applications

Two tool-free locking devices are available for three wire sizes:

- SLK2 compatible with 1.5mm and 2mm wire
- SLK3 compatible with 3mm wire

The locking device can accommodate wire rope at up to 90 degrees, allowing it to be positioned closer to the load than other locking devices on the market, hiding it from view and creating a much more aesthetically pleasing installation.



# Speed Link SLK System

The Speed Link SLK system provides a versatile overhead support solution that is easy to adjust and installs quickly to almost any structure. The system supports a wide range of applications, including ductwork, pipe and tube, cable tray, lighting, conduit, strut profiles and signage from overhead structural building members. It is available with a variety of specialty end fittings for the most common building structure types, a range of wire rope diameters and lengths, and includes a unique keyless locking device.

- Push/pull keyless release allows easy adjustments
- System supports both 1.5 mm and 2 mm cables
- Low-profile locking device minimizes visual impact
- Cable spread of 90 degrees allows positioning the device closer to the load
- Keyless release tubes are easy to operate while wearing gloves
- Double-sided locking mechanism enables simple height adjustment
- Individual packaging holds wire rope neatly until objects are ready to install



Speed Link SLK  
with Angle Bracket



Speed Link SLK  
with Shot-Fire Bracket



Speed Link SLK  
with Decking Hook



Speed Link SLK  
with Hammer-On Flange Clip



Speed Link SLK  
with Hook



Speed Link SLK  
with Loop



Speed Link SLK  
with Threaded Stud End



Speed Link SLK  
with Toggle



Speed Link SLK  
with Y-Hook



Speed Link SLK  
with Y-Toggle



Speed Link SLK  
with Wedge Anchor

# Speed Link SLK with Angle Bracket

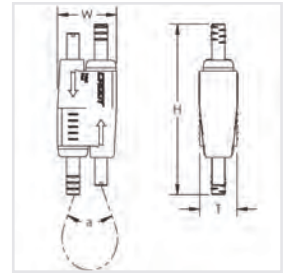
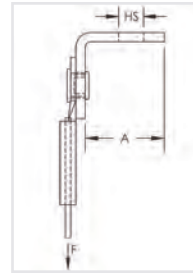

- Complete system includes wire, locking device and pre-assembled angle bracket end fitting
- Ideal for attaching to concrete, steel or wood surfaces
- Simple alternative to jack chain and additional hardware

Material: Steel, Zinc alloy, Polypropylene  
 Finish: Electro-galvanized  
 Static Load Safety Factor: 5:1



Part Number	Wire Rope Length	A	Hole Size HS	Static Load F
<b>Wire Rope Diameter: 1.5 mm</b>				
SLK15L1AB	3.3'	0.891"	0.281"	44 lb
SLK15L2AB	6.6'	0.891"	0.281"	44 lb
SLK15L3AB	9.9'	0.891"	0.281"	44 lb
SLK15L5AB	16.4'	0.891"	0.281"	44 lb
<b>Wire Rope Diameter: 2.0 mm</b>				
SLK2L2AB	6.6'	0.891"	0.281"	100 lb
SLK2L3AB	9.9'	0.891"	0.281"	100 lb
SLK2L5AB	16.4'	0.891"	0.281"	100 lb

  

Height H	Width W	Thickness T	Angle a
2.15"	3/4"	1/2"	90° Max

# Speed Link SLK with Shot-Fire Bracket



- Complete system includes wire, locking device and shot-fire bracket with pre-assembled drive pin from Powers Fasteners, Inc.
- Quickly and easily attaches to concrete, steel or composite metal decking using gas and powder-activated tools
- ICC-ES evaluation report available for drive pin from Powers Fasteners, Inc.

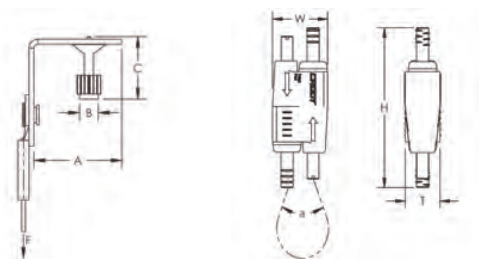

Material: Steel, Zinc alloy, Polypropylene

Finish: Electro-galvanized

Static Load Safety Factor: 5:1



Part Number	Wire Rope Length	A	B	C	Static Load F
<b>Wire Rope Diameter: 1.5 mm</b>					
SLK15L1SF	3.3'	1.48"	0.3"	1 1/4"	44 lb
SLK15L2SF	6.6'	1.48"	0.3"	1 1/4"	44 lb
SLK15L3SF	9.9'	1.48"	0.3"	1 1/4"	44 lb
SLK15L5SF	16.4'	1.48"	0.3"	1 1/4"	44 lb
<b>Wire Rope Diameter: 2.0 mm</b>					
SLK2L2SF	6.6'	1.48"	0.3"	1 1/4"	100 lb
SLK2L3SF	9.9'	1.48"	0.3"	1 1/4"	100 lb
SLK2L5SF	16.4'	1.48"	0.3"	1 1/4"	100 lb

Height H	Width W	Thickness T	Angle a
2.15"	3/4"	1/2"	90° Max

Uses Powers Fasteners, Inc. part number 50032. For minimum fastener embedment depths in steel or concrete, please consult [www.powers.com](http://www.powers.com).

Pre-assembled drive pin from Powers Fasteners, Inc. works with SPIT® P200, P45, P60; Ramset® TS750P, TS60P; Hilti® DX36M, DX350, DX351, DXA40; Würth Diva-1, BST-1, BST-2 or equivalent nailers.

# Speed Link SLK with Decking Hook



- Complete system includes wire, locking device and pre-assembled decking hook end fitting
- Quickly and easily attaches to hollow metal decking
- Spring-loaded ends snap into decking hole and lock into place
- Innovative design helps protect the wire from sharp edges of decking hole, minimizing risk of damage to wire

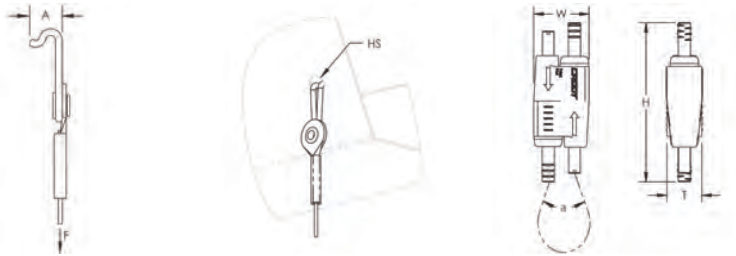

Material: Steel, Zinc alloy, Polypropylene  
 Finish: Electro-galvanized  
 Static Load Safety Factor: 5:1



Part Number	Wire Rope Length	Roof Decking Sheet Thickness	A	Hole Size HS	Static Load F
<b>Wire Rope Diameter: 1.5 mm</b>					
SLK15L3DH	9.9'	16 GA Max	0.36"	0.315"	44 lb
SLK15L5DH	16.4'	16 GA Max	0.36"	0.315"	44 lb
<b>Wire Rope Diameter: 2.0 mm</b>					
SLK2L3DH	9.9'	16 GA Max	0.36"	0.315"	100 lb
SLK2L5DH	16.4'	16 GA Max	0.36"	0.315"	100 lb
SLK2L7DH	22.9'	16 GA Max	0.36"	0.315"	100 lb
Height H	Width W	Thickness T	Angle a		
2.15"	3/4"	1/2"	90° Max		

Load rating is only applicable if the load-bearing capacity of the supporting element (steel decking) is adequate. Check with deck manufacturer for recommended load capacity.

# Speed Link SLK with Hammer-On Flange Clip



- Complete system includes wire, locking device and pre-assembled nVent CADDY Hammer-On Flange Clip end fitting
- Installs with just a hammer
- Fits most beams and bulb tees

Material: Spring Steel, Zinc alloy, Polypropylene

Finish: Electro-galvanized

Static Load Safety Factor: 5:1



Part Number	Wire Rope Length	Flange Thickness FT	Static Load F
<b>Wire Rope Diameter: 1.5 mm</b>			
SLK15L34H24	9.9'	1/8" – 1/4"	44 lb
SLK15L34H58	9.9'	5/16" – 1/2"	44 lb
<b>Wire Rope Diameter: 2.0 mm</b>			
SLK2L34H24	9.9'	1/8" – 1/4"	100 lb
SLK2L34H58	9.9'	5/16" – 1/2"	100 lb
Height H	Width W	Thickness T	Angle a
2.15"	3/4"	1/2"	90° Max

# Speed Link SLK with Hook

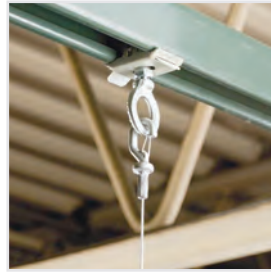

- Complete system includes wire, locking device and pre-assembled hook end fitting
- Hooks to a wide range of nVent CADDY fasteners
- Fastens to the building structure or hanging services by looping around and hooking to wire rope
- Easy to remove for applications requiring maintenance
- Spring latch helps provide secure connection
- Insert cable through hole and use bottom side of hook as an end stop
- Also available in Y-hook configuration

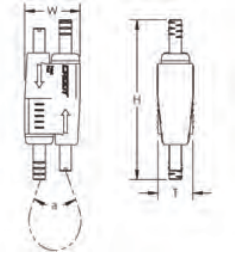
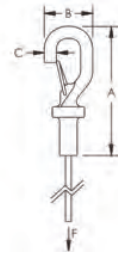

Material: Steel, Polypropylene, Zinc alloy  
 Finish: Electro-galvanized  
 Static Load Safety Factor: 5:1



Part Number	Wire Rope Length	A	B	C	Static Load F	Standard Packaging Quantity
<b>Wire Rope Diameter: 1.5 mm</b>						
SLK15L1	3.3'	2.3"	0.9"	1/4"	44 lb	20 pc
SLK15L2	6.6'	2.3"	0.9"	1/4"	44 lb	20 pc
SLK15L2R2	6.6'	1.89"	0.71"	0.18"	44 lb	15 x 2 pc
SLK15L3	9.9'	2.3"	0.9"	1/4"	44 lb	20 pc
SLK15L3R2	9.9'	1.89"	0.71"	0.18"	44 lb	15 x 2 pc
SLK15L5	16.4'	2.3"	0.9"	1/4"	44 lb	20 pc
SLK15L5R2	16.4'	1.89"	0.71"	0.18"	44 lb	15 x 2 pc
SLK15L7	22.9'	2.3"	0.9"	1/4"	44 lb	20 pc
SLK15L10	32.8'	2.3"	0.9"	1/4"	44 lb	20 pc
<b>Wire Rope Diameter: 2.0 mm</b>						
SLK2L1	3.3'	2.3"	0.9"	1/4"	100 lb	10 pc
SLK2L2	6.6'	2.3"	0.9"	1/4"	100 lb	10 pc
SLK2L2R2	6.6'	2.24"	0.79"	0.22"	100 lb	15 x 2 pc
SLK2L3	9.9'	2.3"	0.9"	1/4"	100 lb	10 pc
SLK2L3R2	9.9'	2.24"	0.79"	0.22"	100 lb	15 x 2 pc
SLK2L5	16.4'	2.3"	0.9"	1/4"	100 lb	10 pc
SLK2L5R2	16.4'	2.24"	0.79"	0.22"	100 lb	15 x 2 pc
SLK2L7	22.9'	2.3"	0.9"	1/4"	100 lb	10 pc
SLK2L10	32.8'	2.3"	0.9"	1/4"	100 lb	10 pc
SLK2L10R2	32.8'	2.24"	0.79"	0.22"	100 lb	15 x 2 pc

Height H	Width W	Thickness T	Angle a
2.15"	3/4"	1/2"	90° Max

# Speed Link SLK with Loop

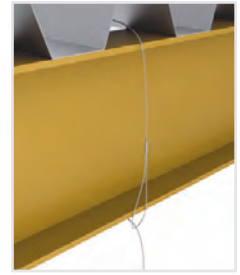
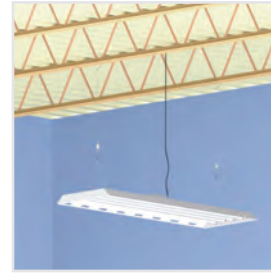

- Complete system includes wire, locking device and pre-assembled loop end fitting
- Easy and flexible solution attaches to building structures
- Wire rope wraps around structure and through loop for quick installation
- Ideal for attaching to purlins, beams and other structural members
- Works well in tight or confined spaces
- Loop attaches directly to pipe, ductwork or other hanging assemblies

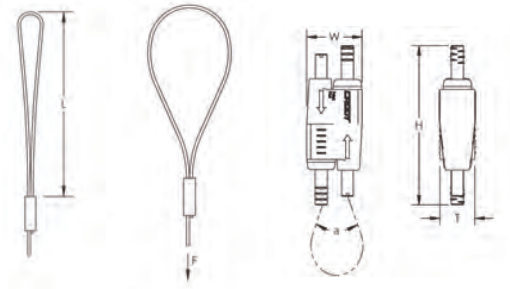

Material: Steel, Polypropylene, Zinc alloy  
 Finish: Electro-galvanized  
 Static Load Safety Factor: 5:1



Part Number	Wire Rope Length	Length L	Static Load F
<b>Wire Rope Diameter: 1.5 mm</b>			
SLK15L1LP	3.3'	4"	44 lb
SLK15L1LPR2	3.3'	4"	44 lb
SLK15L2LP	6.6'	4"	44 lb
SLK15L2LPR2	6.6'	4"	44 lb
SLK15L3LP	9.9'	4"	44 lb
SLK15L3LPR2	9.9'	4"	44 lb
SLK15L5LP	16.4'	4"	44 lb
SLK15L5LPR2	16.4'	4"	44 lb
SLK15L7LP	22.9'	4"	44 lb
SLK15L10LP	32.8'	4"	44 lb
<b>Wire Rope Diameter: 2.0 mm</b>			
SLK2L1LP	3.3'	4"	100 lb
SLK2L2LP	6.6'	4"	100 lb
SLK2L3LP	9.9'	4"	100 lb
SLK2L5LP	16.4'	4"	100 lb
SLK2L7LP	22.9'	4"	100 lb
SLK2L10LP	32.8'	4"	100 lb
Height H	Width W	Thickness T	Angle a
2.15"	3/4"	1/2"	90° Max



# Speed Link SLK with Threaded Stud End



- Complete system includes wire, locking device and pre-assembled threaded stud end fitting
- Attaches to structures with threaded anchors or devices with threaded hole
- Connects directly to threaded devices in trapeze assemblies, light fixtures, HVAC assemblies or signage

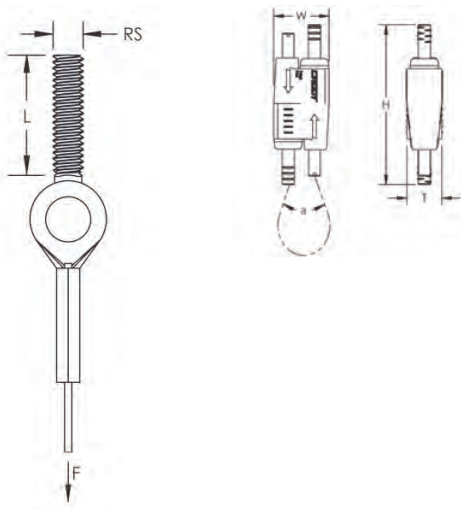

Material: Steel, Polypropylene, Zinc alloy  
 Finish: Electro-galvanized  
 Static Load Safety Factor: 5:1



Part Number	Wire Rope Length	Rod Size RS	Screw Length L	Static Load F
<b>Wire Rope Diameter: 1.5 mm</b>				
SLK15L2SE250	3.3'	1/4"	1"	44 lb
SLK15L3SE250	9.9'	1/4"	1"	44 lb
SLK15L5SE250	16.4'	1/4"	1"	44 lb
<b>Wire Rope Diameter: 2.0 mm</b>				
SLK2L2SE250	6.6'	1/4"	1"	100 lb
SLK2L3SE250	9.9'	1/4"	1"	100 lb
SLK2L5SE250	16.4'	1/4"	1"	100 lb
Height H	Width W	Thickness T	Angle a	
2.15"	3/4"	1/2"	90° Max	

# Speed Link SLK with Toggle

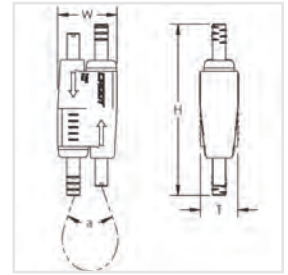
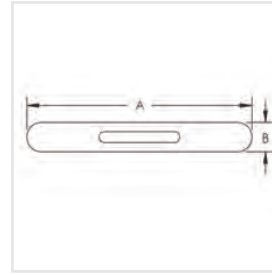
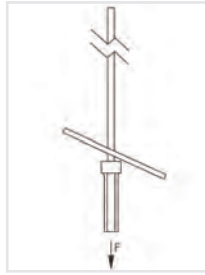

- Complete system includes wire, locking device and pre-assembled toggle end fitting
- Attaches to clearance holes in a variety of structures or hanging devices
- Ideal for supporting lighting fixtures
- Also available in Y-toggle configuration

Material: Steel, Zinc alloy, Polypropylene

Finish: Electro-galvanized

Static Load Safety Factor: 5:1

Wire Rope Diameter: 1.5 mm



Part Number	Wire Rope Length	A	B	Static Load F
SLK15L1T	3.3'	1 1/2"	0.2"	44 lb
SLK15L1TR2	3.3'	1 1/2"	0.2"	44 lb
SLK15L2T	6.6'	1 1/2"	0.2"	44 lb
SLK15L2TR2	6.6'	1 1/2"	0.2"	44 lb
SLK15L3T	9.9'	1 1/2"	0.2"	44 lb
SLK15L3TR2	9.9'	1 1/2"	0.2"	44 lb
SLK15L5T	16.4'	1 1/2"	0.2"	44 lb
SLK15L7T	22.9'	1 1/2"	0.2"	44 lb
SLK15L10T	32.8'	1 1/2"	0.2"	44 lb

Height H	Width W	Thickness T	Angle a
2.15"	3/4"	1/2"	90° Max

# Speed Link SLK with Y-Hook

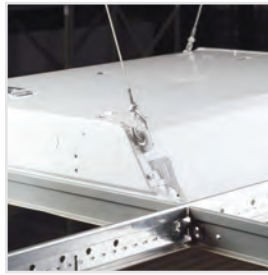

- Complete system includes wire, locking device and two pre-assembled hook end fittings
- Fastens to the building structure and hooks to hanging services and tray
- Spring latch helps provide secure connection
- Convenient design allows one hook to be temporarily detached for maintenance or to add cables to the tray
- Single drop with double hook provides increased stability to the system
- Also available in a single-hook end fitting configuration

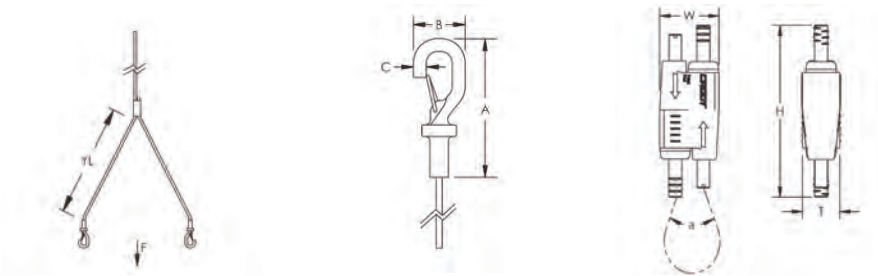

Material: Steel, Zinc alloy, Polypropylene

Finish: Electro-galvanized

Static Load Safety Factor: 5:1

Wire Rope Diameter: 2 mm



Part Number	Wire Rope Length	Wire Rope "Y" Length YL	A	B	C	Static Load F
SLK2YH500L2	6.6'	19.6"	2.3"	0.9"	1/4"	100 lb
SLK2YH500L2R2	6.6'	19.6"	2.3"	0.9"	1/4"	100 lb
SLK2YH500L3	9.9'	19.6"	2.3"	0.9"	1/4"	100 lb
SLK2YH500L3R2	9.9'	19.6"	2.3"	0.9"	1/4"	100 lb
SLK2YH500L7	22.3'	19.6"	2.3"	0.9"	1/4"	100 lb

  

Height H	Width W	Thickness T	Angle a
2.15"	3/4"	1/2"	90° Max

# Speed Link SLK with Y-Toggle

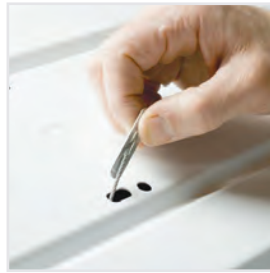

- Complete system includes wire, locking device and two pre-assembled toggle end fittings
- Attaches to clearance holes in a variety of structures or hanging devices
- Ideal for supporting lighting fixtures

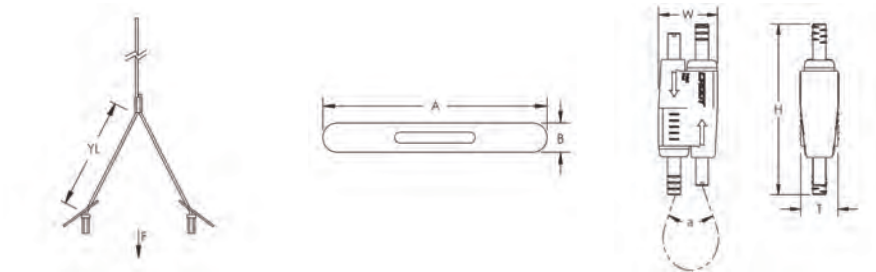

Material: Steel, Zinc alloy, Polypropylene  
 Finish: Electro-galvanized  
 Static Load Safety Factor: 5:1



Part Number	Wire Rope Length	Wire Rope "Y" Length YL	A	B	Static Load F
<b>Wire Rope Diameter: 1.5 mm</b>					
SLK15Y300L3	9.9'	11.8"	1.65"	0.31"	44 lb
SLK15Y300L3R2	9.9'	11.8"	1.50"	0.20"	44 lb
SLK15Y500L3	9.9'	19.6"	1.65"	0.31"	44 lb
SLK15Y500L3R2	9.9'	19.6"	1.50"	0.20"	44 lb
SLK15Y300L5	16.4'	11.8"	1.65"	0.31"	44 lb
<b>Wire Rope Diameter: 2.0 mm</b>					
SLK2Y300L2	6.6'	11.8"	1.65"	0.31"	100 lb
SLK2Y300L3	9.9'	11.8"	1.65"	0.31"	100 lb
SLK2Y300L3R2	9.9'	11.8"	1.65"	0.31"	100 lb
SLK2Y500L3	9.9'	19.6"	1.65"	0.31"	100 lb
SLK2Y300L5	16.4'	11.8"	1.65"	0.31"	100 lb
SLK2Y300L7	22.9'	11.8"	1.65"	0.31"	100 lb
SLK2Y300L10	32.8'	11.8"	1.65"	0.31"	100 lb
Height H	Width W	Thickness T	Angle a		
2.15"	3/4"	1/2"	90° Max		

# Speed Link SLK with Wedge Anchor



- Complete system includes wire, locking device and wedge anchor from Powers Fasteners, Inc.
- Quickly and easily attaches into cracked and non-cracked concrete
- No special tools required

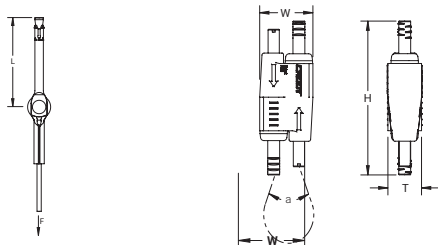

Material: Steel; Polypropylene; Zinc Alloy  
 Finish: Electrogalvanized  
 Static Load Safety Factor: 5:1  
 Drill Bit Diameter: 1/4"  
 Drill Bit Depth: 2.4"



Part Number	Wire Rope Length	Length L	Height H	Width W	Thickness T	Angle a	Static Load F
<b>Wire Rope Diameter: 2 mm</b>							
SLK2L2WA6	6.6'	2.50"	2.15"	0.75"	0.5"	90° Max	100 lb
SLK2L3WA6	9.9'	2.50"	2.15"	0.75"	0.5"	90° Max	100 lb
SLK2L5WA6	16.4'	2.50"	2.15"	0.75"	0.5"	90° Max	100 lb
SLK2L7WA6	22.9'	2.50"	2.15"	0.75"	0.5"	90° Max	100 lb
<b>Wire Rope Diameter: 3 mm</b>							
SLK3L1WA6	3.3'	2.50"	2.50"	0.90"	0.6"	90° Max	200 lb
SLK3L2WA6	6.6'	2.50"	2.50"	0.90"	0.6"	90° Max	200 lb
SLK3L3WA6	9.9'	2.50"	2.50"	0.90"	0.6"	90° Max	200 lb
SLK3L5WA6	16.4'	2.50"	2.50"	0.90"	0.6"	90° Max	200 lb
SLK3L7WA6	22.9'	2.50"	2.50"	0.90"	0.6"	90° Max	200 lb
SLK3L10WA6	32.8'	2.50"	2.50"	0.90"	0.6"	90° Max	200 lb

Uses Powers Fasteners, Inc. part number 7409SD1.  
 For minimum fastener embedment depths in concrete, please consult [www.powers.com](http://www.powers.com).

# Speed Link LD System

The Speed Link LD system is ideal for hanging light-duty fixtures, ductwork, speakers, alarm sensors, signage and pipes in applications that require all stainless steel components for a greater corrosion resistance.

- Systems include locking device, 1.5 mm diameter wire rope, and specialty end fitting
- Low-profile locking device minimizes visual impact
- Individual packaging holds wire rope neatly until objects are ready to install
- Supported objects are easy to adjust both during and after installation

## Speed Link LD with Hook



- Complete system includes wire, locking device and pre-assembled hook end fitting
- Hooks to a wide range of nVent CADDY fasteners
- Fastens to the building structure or hanging services by looping around and hooking to wire rope
- Easy to remove for applications requiring maintenance
- Spring latch helps provide secure connection
- Insert cable through hole and use bottom side of hook as an end stop

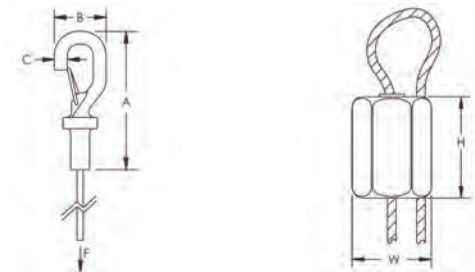

Material: Stainless steel 304  
Static Load Safety Factor: 5:1



Part Number	Wire Rope Length	Wire Rope Diameter	A	B	C	Static Load F	Standard Packaging Quantity
SLD15L2S	6.6'	1.5 mm	2.3"	0.9"	1/4"	44 lb	20 x 2 pc
SLD15L5S	16.4'	1.5 mm	2.3"	0.9"	1/4"	44 lb	20 x 2 pc
SLD15L10S	32.8'	1.5 mm	2.3"	0.9"	1/4"	44 lb	20 x 2 pc
Height H			Width W				
3/4"			1/2"				

# Speed Link SLS Device

## SAFETY FEATURES

Length of stem allows the device to be installed in strut profiles without the need to insert fingers or tools into the strut

UL Listing on all 4 end fittings for pre-cut lengths

Two jaws grip the wire inside the device, holding the wire more securely than single-cam devices common among most competitors

Keyless release tube is designed to allow safe and easy adjustment, even while wearing bulky gloves

The color of the line corresponds to the larger goal of each feature:

## SAFETY FEATURES

## AESTHETICAL FEATURES

## EASE OF USE FEATURES

## AESTHETICAL FEATURES

Low-profile locking device provides a positive aesthetic to a finished project

## EASE OF USE FEATURES

"Push-to-install" retaining nut simplifies installation

Engineered elongated retaining nut reduces unwanted sway of the trapeze during installation and provides higher stability

The outside of the housing is threaded for easy and secure attachment to the nut

Speed Link is lighter, faster to install, easier to transport and generates less waste than alternative hanging methods

Two tool-free locking devices are available for three wire sizes:

- SLS2 compatible with 1.5mm and 2mm wire
- SLS3 compatible with 3mm wire

Similar housing style creates a consistent look when used in projects alongside the Speed Link SLK System

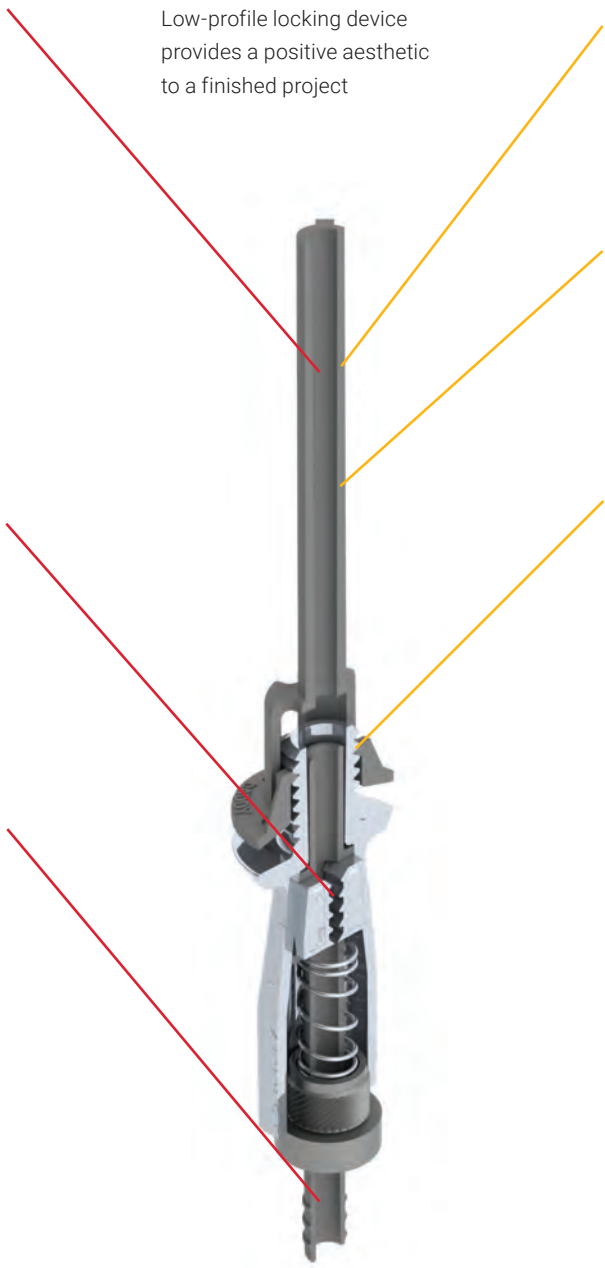

# Speed Link SLS System

The Speed Link SLS system is an innovative cable solution for supporting metal framing channels, ceiling fan units, and other hangers. The locking device is similar to the keyless design of Speed Link SLK but with a single barrel. The outside of the housing is threaded and is held in a channel or hanger by a push-to-install retaining nut. This engineered elongated retaining nut reduces unwanted sway of the trapeze during installation and provides higher stability. The system allows for quick and easy prefabrication of complex assemblies at ground level that can be easily lifted and held in place by wire rope.

- Single barrel locking device allows for quick prefabrication of strut or brackets
- Push-on nut quickly and securely installs to strut or bracket to keep the locking device in position and eases installation
- Finger tightening of nut secures the locking device into position without tools
- Installs in strut profiles without the need to insert fingers or tools into the strut
- Push-on nut guides the cable into the locking device and brings stability to the support
- Installs with open side of the strut channel facing up or down for more flexibility



Speed Link SLS  
with Decking Hook



Speed Link SLS  
with Hook



Speed Link SLS  
with Threaded Stud End



Speed Link SLS  
with Wedge Anchor



# Speed Link SLS with Decking Hook



- Complete system includes wire, locking device and pre-assembled decking hook end fitting
- Quickly and easily attaches to hollow metal decking
- Spring-loaded ends snap into decking hole and lock into place
- Innovative design helps protect the wire from sharp edges of decking hole, minimizing risk of damage to wire

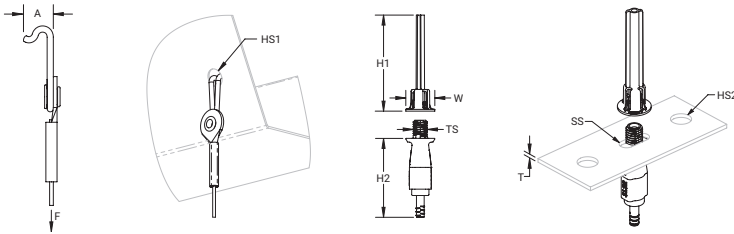

Material: Steel; Polypropylene; Zinc Alloy  
 Finish: Electrogalvanized  
 Static Load Safety Factor: 5:1  
 Wire Rope Diameter: 2 mm



Part Number	Wire Rope Length	Roof Decking Sheet Thickness	A	Hole Size 1 HS1	Static Load F
SLS2L3DH	9.9'	16 GA Max	0.36"	0.315"	60 lb
SLS2L5DH	16.4'	16 GA Max	0.36"	0.315"	60 lb
SLS2L7DH	22.9'	16 GA Max	0.36"	0.315"	60 lb

Thread Size TS	Height 1 H1	Height 2 H2	Width W	Thickness T	Hole Size 2 HS2	Slot Size SS
M8	2.1"	1.8"	0.6"	0.15" Max	0.31" – 0.38"	0.31" x 0.25" - 0.31" x 0.38"

The 2 mm locking device is compatible with C-Channel Types E0 and E0L.  
 Total load per wire on a multi-tier trapeze must not exceed static load.  
 Load rating is only applicable if the load-bearing capacity of the supporting element (steel decking) is adequate.  
 Check with deck manufacturer for recommended load capacity.

Speed Link SLS System

# Speed Link SLS with Hook



- Complete system includes wire, locking device and pre-assembled hook end fitting
- Hooks to a wide range of nVent CADDY fasteners
- Fastens to the building structure or hanging services by looping around and hooking to wire rope
- Easy to remove for applications requiring maintenance
- Spring latch helps provide secure connection
- Insert cable through hole and use bottom side of hook as an end stop

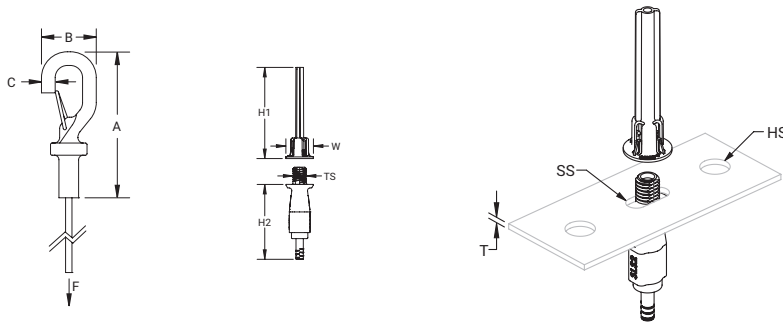

Material: Steel; Polypropylene; Zinc Alloy  
 Finish: Electrogalvanized  
 Static Load Safety Factor: 5:1

Wire Rope Diameter: 2 mm



Part Number	SLS2L1	SLS2L2	SLS2L3	SLS2L5	SLS2L7	SLS2L10
Wire Rope Length	3.3'	6.6'	9.9'	16.4'	22.9'	32.8'
A	2.24"					
B	0.79"					
C	0.22"					
Height 1 (H1)	2.1"					
Height 2 (H2)	1.7"					
Thread Size (TS)	M8					
Width (W)	0.63"					
Hole Size (HS)	0.31" – 0.38"					
Slot Size (SS)	0.31" x 0.25" - 0.31" x 0.38"					
Thickness (T)	0.15" Max					
Static Load (F)	60 lb					
Standard Packaging Quantity	10 pc					

Wire Rope Diameter: 3 mm

Part Number	SLS3L1	SLS3L2	SLS3L3	SLS3L5	SLS3L7	SLS3L10
Wire Rope Length	3.3'	6.6'	9.9'	16.4'	22.9'	32.8'
A	2.27"					
B	0.91"					
C	0.24"					
Height 1 (H1)	2.1"					
Height 2 (H2)	1.8"					
Thread Size (TS)	M12					
Width (W)	0.80"					
Hole Size (HS)	0.50" – 0.56"					
Slot Size (SS)	0.47" x 0.39" - 0.47" x 0.56"					
Thickness (T)	0.25" Max					
Static Load (F)	150 lb					
Standard Packaging Quantity	10 x 10 pc		10 x 5 pc		5 x 5 pc	

The 2 mm locking device is compatible with C-Channel Types E0 and E0L.

The 3 mm locking device is compatible with C-Channel Types E1, E2, E2L, E3, E4, E5, Strut Channel Type C, Slotted, Strut Channel Type A, Slotted, Strut Channel Type AS, Perforated, Strut Channel Type CC, Slotted, Strut Channel Type AA, Slotted.

Total load per wire on a multi-tier trapeze must not exceed static load.

# Speed Link SLS with Threaded Stud End



- Complete system includes wire, locking device and pre-assembled threaded stud end fitting
- Attaches to structures with threaded anchors or devices with threaded hole

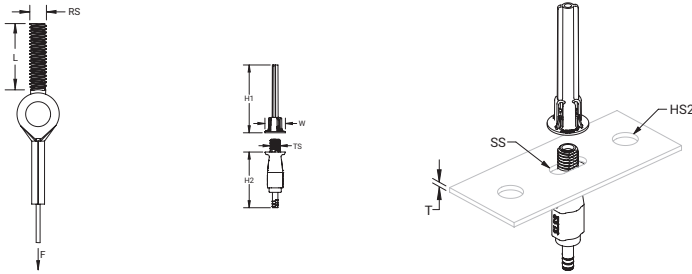

Material: Steel; Polypropylene; Zinc Alloy  
 Finish: Electrogalvanized  
 Static Load Safety Factor: 5:1  
 Wire Rope Diameter: 2 mm



Part Number	Wire Rope Length	Rod Size RS	Screw Length L	Static Load F
SLS2L2SE250	6.6'	1/4"	1"	60 lb
SLS2L3SE250	9.9'	1/4"	1"	60 lb
SLS2L5SE250	16.4'	1/4"	1"	60 lb

Thread Size TS	Height 1 H1	Height 2 H2	Width W	Thickness T	Hole Size 2 HS2	Slot Size SS
M8	2.1"	1.7"	0.63"	0.15" Max	0.31" - 0.38"	0.31" x 0.25" - 0.31" x 0.38"

The 2 mm locking device is compatible with C-Channel Types E0 and E0L.  
 Total load per wire on a multi-tier trapeze must not exceed static load.

# Speed Link SLS with Wedge Anchor

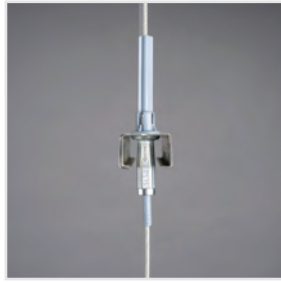

- Complete system includes wire, locking device and wedge anchor from Powers Fasteners, Inc.
- Quickly and easily attaches into cracked and non-cracked concrete
- No special tools required
- ETA-13/0106 approval available for wedge anchor from Powers Fasteners, Inc

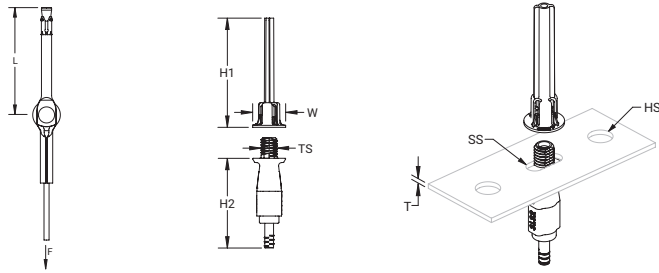

Material: Steel; Polypropylene; Zinc Alloy  
 Finish: Electrogalvanized  
 Static Load Safety Factor: 5:1  
 Wire Rope Diameter: 2 mm



Part Number	Wire Rope Length	Length (L)	Drill Bit Diameter $\emptyset$	Drill Hole Depth	Static Load F
SLS2L3WA6	9.9'	2.50"	1/4"	2.4"	60 lb
SLS2L5WA6	16.4'	2.50"	1/4"	2.4"	60 lb
SLS2L7WA6	22.9'	2.50"	1/4"	2.4"	60 lb

Thread Size TS	Height 1 H1	Height 2 H2	Width W	Thickness T	Hole Size HS	Slot Size SS
M8	2.1"	1.7"	0.63"	0.15" Max	0.31" - 0.38"	0.31" x 0.25" - 0.31" x 0.38"

The 2 mm locking device is compatible with C-Channel Types E0 and E0L.  
 Total load per wire on a multi-tier trapeze must not exceed static load.  
 For minimum fastener embedment depths in concrete, please consult [www.powers.com](http://www.powers.com).  
 Uses Powers Fasteners, Inc. part number 7409SD1.

Speed Link SLS System

# Speed Link Extensions

Speed Link extensions allow standard Speed Link Systems to be lengthened for long drop applications, putting the height adjustment closer to the object being supported. These short sections of wire include speciality end fittings at one end and a small loop or hook at the other. The extensions combine perfectly with other Speed Link Systems, and can also be used separately as a backup wire.

- Ideal for use with standard Speed Link Systems
- A range of end fittings easily adapt to various jobs
- Wire rope is securely looped and crimped
- Ideal as a support or secondary wire



Speed Link Y-Hook with Eyelet Extension



Speed Link Y-Toggle with Eyelet Extension

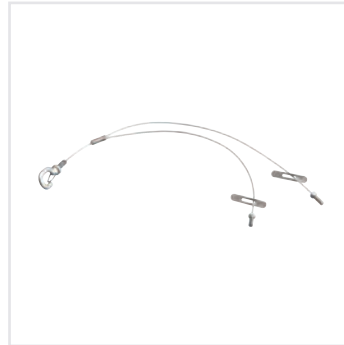

Speed Link Y-Toggle with Hook Extension



Speed Link Quad-Toggle with Eyelet Extension

# Speed Link Y-Hook with Eyelet Extension



- Double hook offers easy attachment to basket tray, cable tray or lighting
- Convenient design allows one hook to be temporarily detached for maintenance or to add cables to the tray
- Y-design provides improved stability
- Spring latch helps provide secure connection

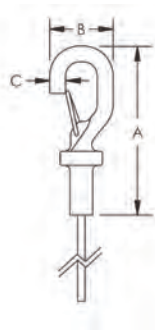

Material: Steel  
 Finish: Electro-galvanized  
 Static Load Safety Factor: 5:1



Part Number	Wire Rope "Y" Length YL	A	B	C	Static Load F
Wire Rope Diameter: 2 mm					
SLD2YH500	19.6"	2.3"	0.9"	1/4"	100 lb
SLD2YH800	31.4"	2.3"	0.9"	1/4"	100 lb
Wire Rope Diameter: 3 mm					
SLD3YH500	19.6"	2.3"	0.9"	1/4"	200 lb
SLD3YH800	31.4"	2.3"	0.9"	1/4"	200 lb

Speed Link locking device not included.

The 2 mm locking device is compatible with C-Channel Types E0 and E0L.

The 3 mm locking device is compatible with C-Channel Types E1, E2, E2L, E3, E4, E5, Strut Channel Type C, Slotted, Strut Channel Type A, Slotted, Strut Channel Type AS, Perforated, Strut Channel Type CC, Slotted, Strut Channel Type AA, Slotted.

Total load per wire on a multi-tier trapeze must not exceed static load.

# Speed Link Y-Toggle with Eyelet Extension

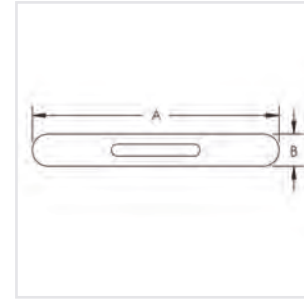
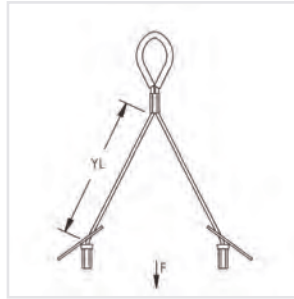

- Attaches to clearance holes in a variety of structures or hanging devices
- Ideal for supporting lighting fixtures
- Y-design provides improved stability

Material: Steel

Finish: Electro-galvanized

Static Load Safety Factor: 5:1



Part Number	Wire Rope "Y" Length YL	A	B	Static Load F	Standard Packaging Quantity
<b>Wire Rope Diameter: 1.5 mm</b>					
SLD15Y200	7.8"	1.65"	0.31"	44 lb	20 pc
SLD15Y300	11.8"	1.65"	0.31"	44 lb	20 pc
SLD15Y500	19.6"	1.65"	0.31"	44 lb	20 pc
SLD15Y500TP	19.6"	1.65"	0.31"	44 lb	20 x 2 pc
SLD15Y800	31.4"	1.65"	0.31"	44 lb	20 pc
SLD15Y800TP	31.4"	1.65"	0.31"	44 lb	20 x 2 pc
<b>Wire Rope Diameter: 2.0 mm</b>					
SLD2Y300	11.8"	1.65"	0.31"	100 lb	20 pc
SLD2Y500	19.6"	1.65"	0.31"	100 lb	20 pc

Speed Link locking device not included.



# Speed Link Y-Toggle with Hook Extension

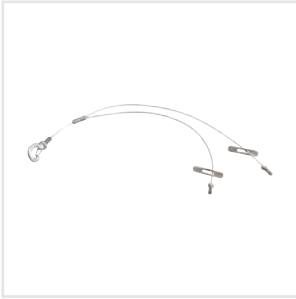

- Attaches to clearance holes in a variety of structures or hanging devices
- Ideal for supporting lighting fixtures
- Y-design provides improved stability
- Spring latch of hook helps provide secure connection
- Hooks to a wide range of CADDY fasteners

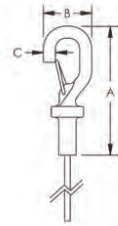

Material: Steel  
 Finish: Electro-galvanized  
 Static Load Safety Factor: 5:1



Part Number	Wire Rope Diameter	Wire Rope "Y" Length YL	Wire Rope Length	A	B	C	D	E	Static Load F
SLD2Y300L050H	2 mm	11.8"	2.0"	2.3"	0.9"	1/4"	1.65"	0.31"	100 lb

Speed Link locking device not included.

# Speed Link Quad-Toggle with Eyelet Extension

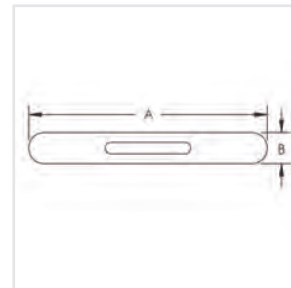
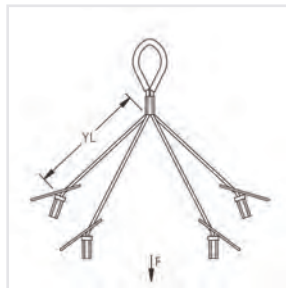
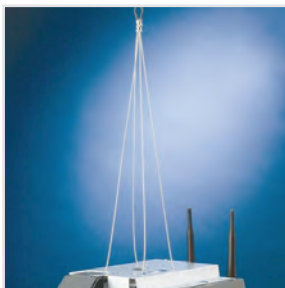

- Secure hanging solution for use on control access points, projectors, etc.

Material: Steel  
 Finish: Electro-galvanized  
 Static Load Safety Factor: 5:1



Part Number	Wire Rope Diameter	Wire Rope "Y" Length YL	A	B	Static Load F
SLD15QT250	1.5 mm	9.8"	1.65"	0.31"	44 lb

Speed Link locking device not included.

# Speed Link Locking Devices and Wire Rope

The individual components of the Speed Link Universal Support System can be configured to meet installers' unique needs. Speed Link locking devices and wire rope are available in bulk and allow installers to customize the system for each project.



Speed Link SLK Spool Kit

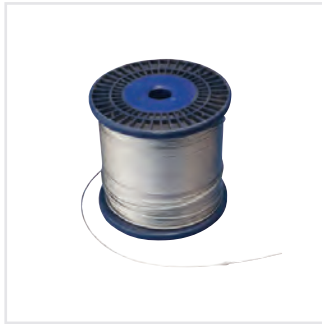

Wire Spool



Wire Rope Cutter



Speed Link SLK Locking Device



Speed Link LD Locking Device



Speed Link SLS Locking Device

# Speed Link SLK Spool Kit



- Kit includes spool of Speed Link steel wire and Speed Link SLK locking devices
- Wire spool and locking devices are packaged together, simplifying transportation to the jobsite and reducing inventory
- Packaging allows end-users to pull and cut any length of wire that is needed without having to take the spool out of the box
- Ideal for rework and installations where custom lengths of wire may be needed
- Wire rope constructed from seven bundles of seven strands each of steel aircraft wire
- Push/pull keyless release allows easy adjustments
- Low-profile locking device minimizes visual impact
- Cable spread of 90 degrees allows positioning the device closer to the load
- Keyless release tubes are easy to operate while wearing gloves
- Double-sided locking mechanism enables simple height adjustment

Material: Steel

Finish: Electrogalvanized

Part Number	Wire Rope Diameter	Length	Number of Locking Devices
SLK15L50MPACK	1.5 mm	164'	25
SLK2L100PACK	2.0 mm	328'	50

## Wire Spool



- Spool with Speed Link steel wire
- Wire rope constructed from seven bundles of seven strands each of steel aircraft wire

Material: Steel

Finish: Electro-galvanized

Part Number	Wire Rope Diameter	Length	Static Load
SLC15L50MSP	1.5 mm	164'	44 lb
SLC15L1000SP	1.5 mm	1,000'	44 lb
SLC2L1000SP	2.0 mm	1,000'	100 lb
SLC3L1000SP	3.0 mm	1,000'	200 lb

## Wire Rope Cutter

- Designed to reduce wire rope fraying

Material: Steel

Part Number
SLWC



# Speed Link SLK Locking Device



- Push/pull keyless release allows easy adjustments
- Suitable for 1.5 mm and 2 mm Speed Link cable
- Low-profile locking device minimizes visual impact
- Cable spread of 90 degrees allows positioning the device closer to the load
- Keyless release tubes are easy to operate while wearing gloves
- Double-sided locking mechanism enables simple height adjustment

Material: Steel, Polypropylene, Zinc alloy

Part Number	Wire Rope Diameter	Height H	Width W	Thickness T	Angle a
SLK2C200	1.5 – 2.0 mm	2.15"	0.75"	0.5"	90° Max
SLK2C50	1.5 – 2.0 mm	2.15"	0.75"	0.5"	90° Max
SLK3C200	3.0 mm	2.50"	0.90"	0.6"	90° Max
SLK3C50	3.0 mm	2.50"	0.90"	0.6"	90° Max

Locking device is only to be used with SLC15L50MSP, SLC15L1000SP and SLC2L1000SP wire spools or 1.5 mm and 2 mm Speed Link accessories. Do not use with any other wires.

Speed Link SLK Spool Kit

# Speed Link LD Locking Device

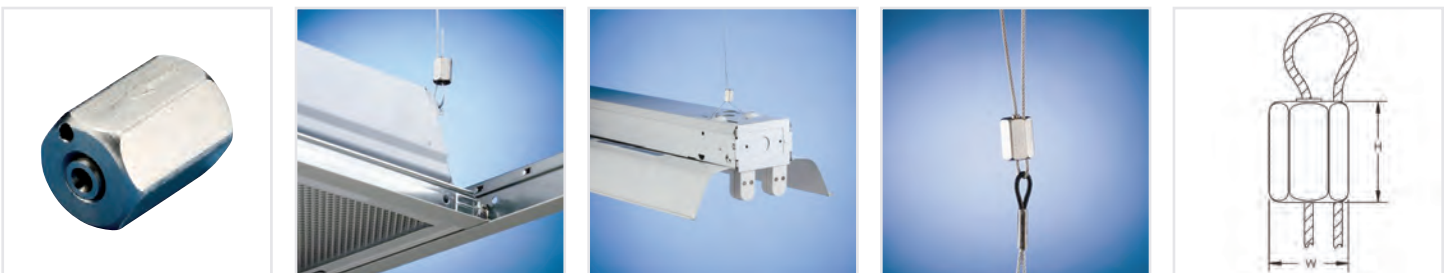

- Low-profile locking device minimizes visual impact
- Suitable for 1.5 mm Speed Link cable

Material: Stainless steel 304

Part Number	Wire Rope Diameter	Height H	Width W
SLJR200	1.5 mm	0.75"	0.5"
SLS2C50	2 mm	2.1"	0.63"
SLS3C50	3 mm	2.1"	0.80"

The 1.5 mm locking devices are only to be used with the SLC15L1000SP and SLC15L50MSP wire spools, or any other 1.5 mm Speed Link accessories. Do not use with any other wires.

# Speed Link SLS Locking Device

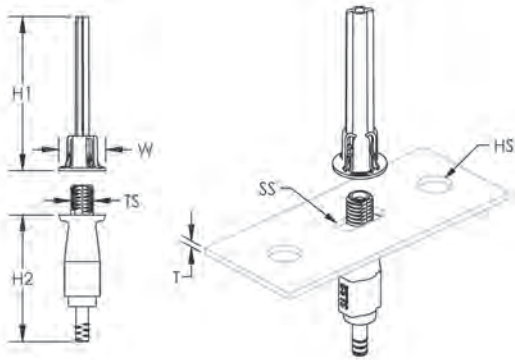

- Single barrel locking device allows for quick prefabrication of strut or brackets
- Push-on nut quickly and securely installs to strut or bracket to keep the locking device in position and eases installation
- Finger tightening of nut secures the locking device into position without tools
- Installs in strut profiles without the need to insert fingers or tools into the strut
- Push-on nut guides the cable into the locking device and brings stability to the support
- Installs with open side of the strut channel facing up or down for more flexibility

Material: Steel, Polypropylene, Zinc Alloy



Part Number	Wire Rope Diameter	Thread Size TS	Height 1 H1	Height 2 H2	Width W	Thickness T	Hole Size HS	Slot Size SS
SLS2C50	2.0 mm	M8	2.1"	1.7"	0.63"	0.15" Max	0.31" – 0.38"	0.31" x 0.25" - 0.31" x 0.38"
SLS3C50	3.0 mm	M12	2.1"	1.8"	0.80"	0.25" Max	0.50" – 0.56"	0.47" x 0.39" - 0.47" x 0.56"

The 2 mm locking device is compatible with C-Channel Types E0 and E0L.

The 3 mm locking device is compatible with C-Channel Types E1, E2, E2L, E3, E4, E5, Strut Channel Type C, Slotted, Strut Channel Type A, Slotted, Strut Channel Type AS, Perforated, Strut Channel Type CC, Slotted, Strut Channel Type AA, Slotted.

Locking devices are only to be used with Speed Link wire spools and accessories with the same specified Wire Rope Diameter as the locking device. Do not use with any other wires.

# Speed Link Accessories

Speed Link accessories are specially designed to work with Speed Link systems. Locking devices and bulk wire are available for highly customized applications. Other accessories complement the Speed Link portfolio to simplify installation.



Air Duct Corner Protector



Air Duct Support Attachment



Concrete Fixing Eyebolt Screw



Eye Screw



Light Duty Light Fixture Eyelet



MC/AC Cable Clip



Angle Bracket With Oblong Hole



The nVent CADDY catalog also has many structural attachments to adapt Speed Link end fittings to most typical structural types. Visit [nVent.com/CADDY](http://nVent.com/CADDY) to view the full nVent CADDY catalog and be sure to contact us if you have questions about a unique configuration.

# Air Duct Corner Protector

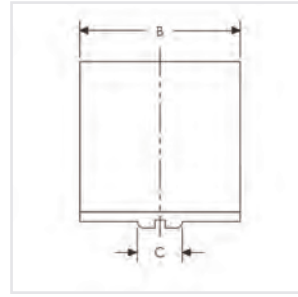
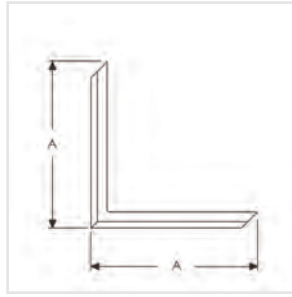
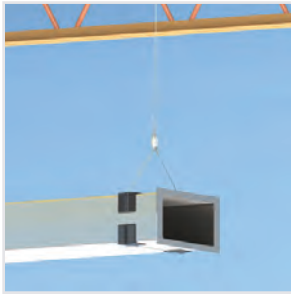
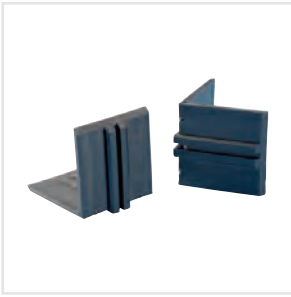

- Includes rib to keep the wire rope in place
- Prevents the wire rope from damaging the duct

Material: Polyvinylchloride  
Color: Black

Part Number	A	B	C
SLADCP	2"	2"	1/2"

# Air Duct Support Attachment

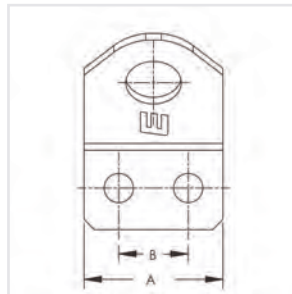

- Angled bracket for installation on to round or square duct
- Designed to accept Speed Link wire rope or hook

Material: Steel  
Finish: Electro-galvanized

Part Number	Hole Size 1 HS1	Hole Size 2 HS2	A	B	Thickness T
SLADS	0.314"	0.165"	0.787"	0.393"	0.059"

# Concrete Fixing Eyebolt Screw

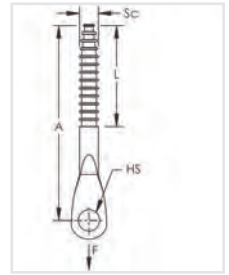

- For use in concrete and brick
- Includes drill bit adaptor for easy installation

Material: Steel  
Finish: Electro-galvanized

Part Number	Hole Size HS	Screw Diameter Sc	Screw Length L	A	Drill Bit Size	Static Load F
CFEB05	0.256"	H6	1.77"	2.36"	0.197"	155 lb

# Eye Screw

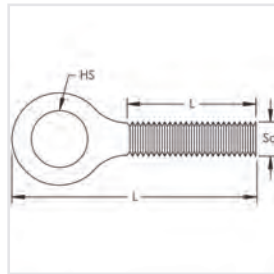

Material: Steel  
Finish: Electro-galvanized

Part Number	Screw Diameter Sc	Screw Length L	Hole Size HS	Length L
SLEB250	1/4"	0.984"	0.283"	1.732"
SLEBWS	H6	2.360"	0.345"	2.375"
SLEB375	3/8"	1.8"	0.283"	2 1/2"



# MC/AC Cable Clip

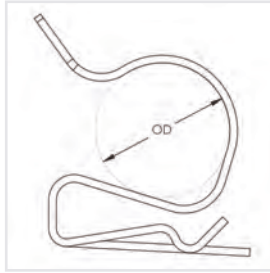
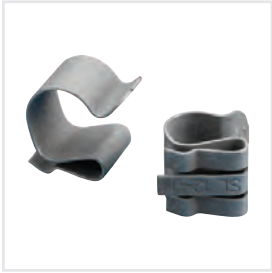

- Spring steel cable attachment
- Allows for electrical cable to be attached to Speed Link wire rope

Material: Spring Steel  
Finish: nVent CADDY Armour

Part Number	Wire Rope Diameter	Outer Diameter OD
SL1214	1.5 – 3.0 mm	0.468" – 0.562"
SL1518	1.5 – 3.0 mm	0.500" – 0.718"

# Light Duty Light Fixture Eyelet

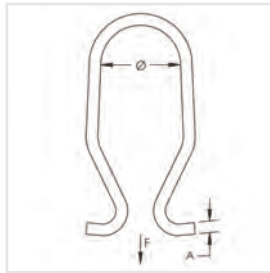

- Inserts into openings of light fixture
- Hook or loop through lighting clip to suspend lighting from wire rope or chain

Material: Stainless steel 302

Part Number	Diameter Ø	A	Static Load F
SLLC250	5/16"	0.052"	12 lb

Do not use light fixture eyelet as a lifting device.

# Multiply the time savings and flexibility with Telescoping Strut Replacement (TSR1220N)

Like strut, the Speed Link SLS3 locking device can be inserted directly into the holes at the end of the TSR1220N. Unlike strut, Telescoping Strut Replacement products\* are simply extended to any length between 12 and 20 inches, and locked in place by snapping closed a spring steel retainer clip.

In addition to the quick installation of Speed Link, the TSR1220N eliminates the need to transport, measure, cut, and deburr strut. The telescoping feature also allows for quick on-site adjustments.



\*The Speed Link SLS3 locking device is only compatible with the TSR1220N. Visit [nVent.com/ERICO](http://nVent.com/ERICO) to see other Telescoping Strut Replacement installations.

# Save Time on Heavy Duty Installations with nVent CADDY Rod Lock

Want to reap the time-saving benefits of Speed Link but require a higher load rating? CADDY ROD LOCK is the solution for quick threaded rod installations. The unique "push-to-install" mechanism allows for the prefabrication of complex assemblies on the ground or off-site that can easily be lifted and locked into place. Installers no longer need to spend hours spinning hardware up threaded rod.

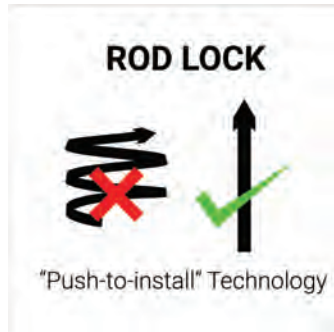

Build. Lift. Done.



Rod Lock technology is available on structural attachments as well as supports. Whatever the threaded rod application, Rod Lock products can help installers save time and money on the job site.

Go to [nVent.com/CADDY](http://nVent.com/CADDY) to learn more about Rod Lock and how it can help you save time on your next project.

Our powerful portfolio of brands:

**CADDY ERICO HOFFMAN RAYCHEM SCHROFF TRACER**



[nVent.com/CADDY](https://www.nVent.com/CADDY)

©2018 nVent. All nVent marks and logos are owned or licensed by nVent Services GmbH or its affiliates. All other trademarks are the property of their respective owners. nVent reserves the right to change specifications without notice.

CADDY-SB-FM1161B-DFM489LT17NA-EN-1805