

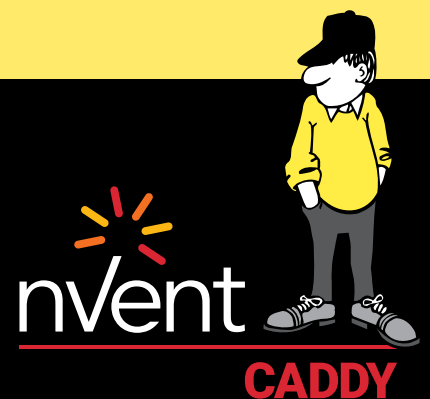

CONNECT AND PROTECT

Rod Lock

The nVent CADDY Rod Lock Threaded Rod Mounting System allows modular fabrication of complex assemblies at ground level or offsite, and then easily lift and lock them into place by pushing the threaded rod supports into the Rod Lock device



nVent CADDY Rod Lock

Off-site fabrication (sometimes called modular fabrication) is the process that allows for parts to arrive at a job site preassembled. More and more, contractors are leveraging the efficiencies provided by off-site fabrication, including

- cost savings
- better time management
- safer installations

These benefits apply to a variety of projects, regardless of size or scope.

Historically, complex assemblies were built on-site at the location where they were to be mounted. Installers, therefore, required constant access to the job site in order to keep a project moving according to schedule.

With off-site fabrication, assembly is completed in a space devoted to the production and storage of components. By completing these tasks off-site, contractors can mass-produce assemblies used in similar projects, and on-site installers can focus exclusively on mounting the finished product.

Today, contractors can leverage a range of emerging solutions that allow for new and unique ways to fabricate off-site. While the process may require a new approach to processes such as purchasing, creating and installing assemblies—as well as hardware used during the mounting of a finished piece—off-site fabrication yields countless benefits.

In today's competitive construction market, contractors must provide quality work while lowering labor costs and project time and adhering to safety standards.

The Rod Lock "Push-to-Install" technology allows modular fabrication of complex assemblies off-site or on the ground. Large assemblies can simply then be lifted and locked into place.

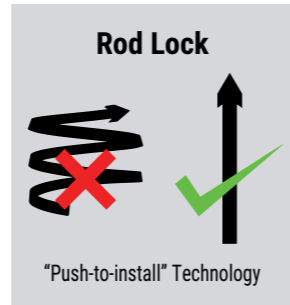

The process requires less time on the job site, allowing for more tasks to be completed in a controlled off-site facility. As a result, off-site fabrication reduces installation costs, enables schedule flexibility and improves safety.

While results may vary based on specific product and application, studies have shown the unique features of the Rod Lock system help reduce the installation time of threaded rod by up to **52 percent** compared to conventional fasteners.

“[Off-site fabrication] is vital to this project both to deal with the delays, and also to help manage the materials. [...] And, we expect labor savings by moving work into the controlled environment of the shop.”

Will Vranich - Smith & Oby
(United States)

For both contractors and their clients, off-site fabrication offers a host of benefits—chief among these is time savings. In fact, modular fabrication makes schedule compression possible by as much as 18 percent. While this includes the ability to complete a job more quickly, other time related perks should be noted.

More Lead Time

Contractors can plan for projects sooner, and installers can prepare pieces in advance at the off-site shop. They can then quickly install assemblies, requiring less time at the job site.

Less Downtime

Workers can fill gaps in their schedules with projects in the off-site shop. Contractors and installers can rely on more consistent and efficient work schedules.

Schedule Flexibility

To combat restrictions of job site schedules or city ordinances, a majority of prefab work can be completed off-site. Off-site shops can run anytime day or night, allowing for quicker turnaround and enabling the contractor to have greater control over the team's project schedule.

STRUCTURE

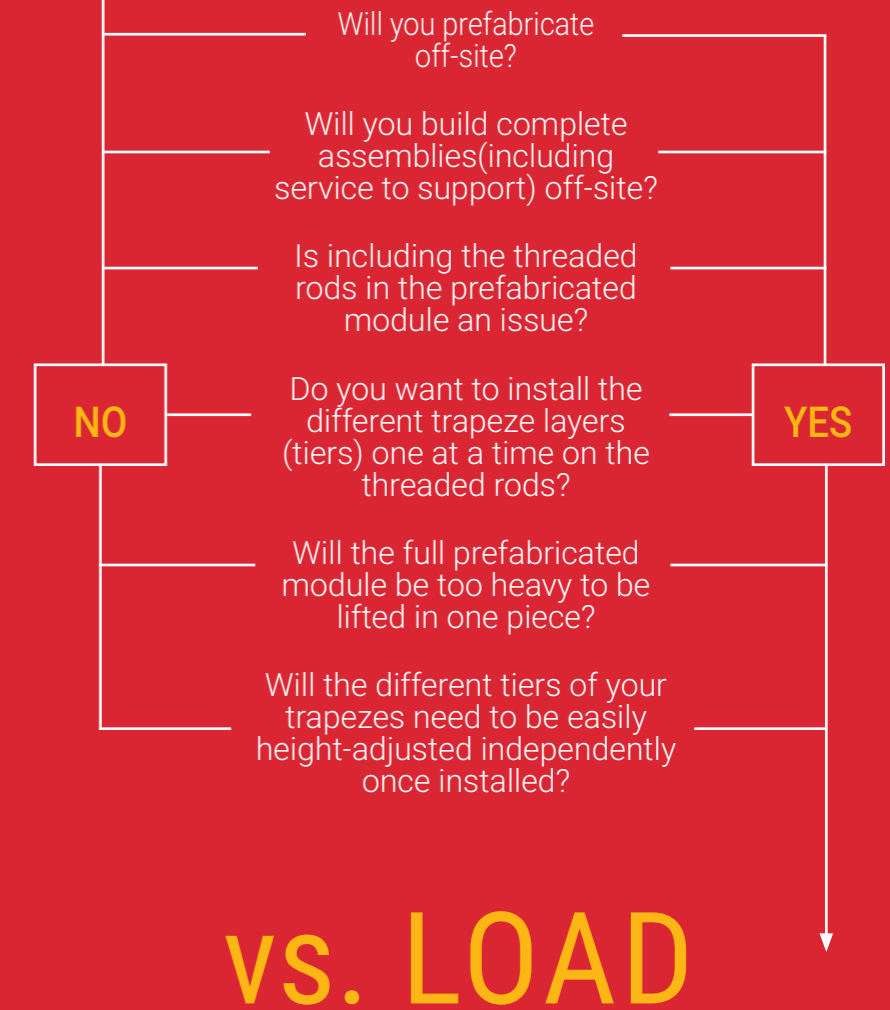

Installation at Structure

	Beam Clamp (3-10 mm)	Beam Clamp, Thick Flange (9.5-20 mm)	Anchor Screw	L-Bracket	Coupler	Coupler with Rod
Rod Lock Product						
Page	12	12	13	13	14	14
Application						
Is the assembly being attached to concrete - wall?				✓		
Is the assembly being attached to concrete - ceiling?			✓			
Is the assembly being attached to I-Beam or flange?	✓	✓				
Is the assembly being attached to existing/already installed threaded rods or male anchors?					✓	
Is the assembly being attached to existing/already installed female anchors?						✓

Structure vs. Load

Having the right hardware can make a modular fabrication assembly even more efficient during installation.

Structural attachments are ideal for on-site (partial) off-site fabrication projects, reducing the time spent in the air. Additionally, they are height-adjustable at the structure, but different trapezes can be more difficult to readjust. These attachments are most often used on heavier modules.

Supports are ideal for off-site (full) off-site fabrication projects. They are height-adjustable at the load, and the height for each tier can easily be altered. These are lighter modules, offering easier transportation. Additionally, they allow for prefab using fire-rating structural attachments.

Internal studies have indicated time savings of up to 69% with one person installing a 2-tier trapeze with Rod Lock Strut (compared to traditional installation).



Pipe Rack Installation

Known Rod Spacing

When installing to a specific rod spacing, the best option is Rod Lock Strut. The pipe runs can be easily lifted and locked into place using Rod Lock "Push-to-Install" technology. It is available for widths of 600-1100mm, and ordered in advance to the desired pre-cut length – eliminating the need for handling long lengths of strut and all the cumbersome activities associated to it.

Unknown Rod Spacing

To install with unknown rod spacing, contractors should use the Rod Lock Telescoping Strut Replacement. The part has Rod Lock hardware at each end of the bar, but can telescope between 318-508mm, and eliminates the need for cutting strut.

Retrofitting

When fabricating off-site retrofit runs of conduit, attach pipe to a TSR1220R. This retrofit version of the Telescoping Strut Replacement can be placed above an existing trapeze and held in place with four nVent CADDY SN Nuts.

"As a specialist for drainage pipe systems we count on Rod Lock when it comes to install roof drainage systems. I, as a project leader, appreciate most the time- and with that the cost-savings achieved thanks to the use of Rod Lock."

Karl Konarzewski - DWD Group GmbH (Germany)









The spacing between pipes across the channel needs to be the same so that they meet up with each other when the individual runs are installed. It is recommended that installers use custom wooden jigs with notches at the spacing for each piece. They can be easily made on the jobsite with pieces of wood and customized for individual situations.

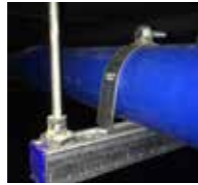

The channel is laid next to the jig and the pipe is attached to it. A variety of CADDY fasteners can be used to hold the pipes to the channel. This process is repeated based on the number of runs needed for the total length of pipe on the project.

The threaded rod is attached at structure in advance.













Conduit / Pipe Rack Installation	Channel Nut	Strut	Telescoping Strut Replacement
			
Page	17	15	16
Application			
Out-of-the-box support		✓	✓
Accommodates strut with its open side facing down	✓		
Accommodates strut with its open side facing up	✓	✓	✓
Accommodates large variances in threaded rod location	✓		✓
Height adjustable		✓	✓
Ability to lock the "push-to-install" system		✓	✓

Light Installation	Channel Nut	
		
	Page	17
	Application	
Accommodates strut with its open side facing down	✓	
Accommodates large variances in threaded rod location	✓	





Prefabricated Module Installation	L-Bracket	Channel Nut
		
Page	13	17
Application		
Compatible with strut frame		✓
Compatible with non-strut frame	✓	
No extra hardware needed		✓
Accommodates strut with its open side facing down		✓
Accommodates large variances in threaded rod location	✓	✓*
Height adjustable	✓	✓
Ability to lock the "push-to-install" system	✓	

* For non-strut frame only. Holes must be drilled in frame.

Cable Tray Installation

	L-Bracket	Wire Basket Support Clip	Strut	Telescoping Strut Replacement	Channel Nut
Rod Lock Product					
Page	13	17	15	16	17
Application					
Basket tray		✓	✓	✓	✓
Perforated tray	✓		✓	✓	✓
Cable ladder	✓		✓	✓	✓
Lay-in cable / wire					
Multi-tier assemblies	✓	✓	✓	✓	✓
Out-of-the-box support		✓	✓	✓	
Material cost independent of tray width	✓	✓		✓	
No restriction on tray width	✓	✓	✓		✓
Standard version available for using Rod Lock technology at the structure	✓				
Accommodates strut with open side facing down					✓
Accommodates large variances in threaded rod locations				✓	✓
Height adjustable	✓	✓	✓	✓	
Ability to lock the "push-to-install" system	✓	✓	✓	✓	

Air Duct Installation

	Channel Nut	Strut	Telescoping Strut Replacement
Rod Lock Product			
Page	17	15	16
Application			
Out-of-the-box support		✓	✓
Material cost independent of duct width			✓
Material cost independent of duct height			
Support duct wider than 1500 mm without engineering analysis	✓	✓	
Install hanger to the duct on the ground			
Does not penetrate the duct with screws	✓	✓	✓
Accommodates strut with open side facing down	✓		
Accommodates large variances in threaded rod locations	✓		✓
Height adjustable		✓	✓
Ability to lock the "push-to-install" system		✓	✓

Air Duct Installation







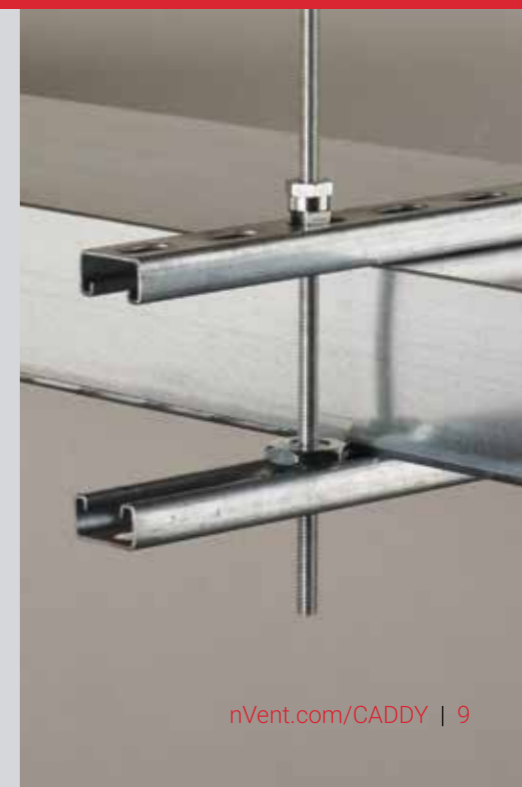

Rectangular duct can be installed two ways using off-site fabrication: attaching directly to the duct or attaching the duct to strut. In both situations, Rod Lock "push-to-install" technology enables easy installation of preassembled pieces.

When attaching directly to the duct, installers should screw Rod Lock Duct Brackets into the side of the duct. Threaded rod should be attached at structure, and the duct assemblies are easily lifted and locked into place.

In strut mounted applications, duct is attached to Rod Lock Strut and the strut is pushed onto the threaded rods.



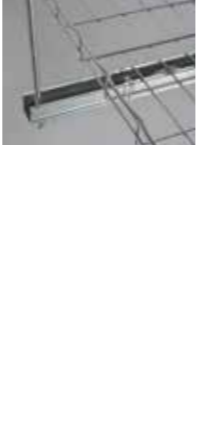



Goal-post Installation

	SNSW Flanged Nut	Strut	Telescopic Strut Replacement	Channel Nut
Rod Lock Product				
Page	18	15	16	17
Application				
Out-of-the-box support		✓	✓	
Material cost independent of goal-post length			✓	
No loose hardware when installed onto strut channel		✓	✓	✓
Accommodates strut with open side facing down	✓			✓
Accommodates large variances in threaded rod locations			✓	✓
Height adjustable	✓	✓	✓	
Ability to lock the "push-to-install" system		✓	✓	
"Push-to-install" system		✓	✓	✓
Easy and fast uninstallation	✓			



Retrofit Installation

	TSR1220R + SN Nuts	ISSP + SN Nuts
Product		
Page	18	18
Application		
Accommodates strut with open side facing down	✓	
Accommodates strut with open side facing up	✓	✓
Suitable for trapeze with threaded rods >508 mm apart		✓
Material cost independent of trapeze length	✓	
Height adjustable	✓	✓
Tool-free	✓	

Rod Lock Beam Clamps

- Prefabricated assemblies easily lift and lock into place, helping to save time and money
- Easy “push-to-install” design allows installers to simply push the threaded rod through the mounting hole, instantly holding it in position
- Lock nut can be finger tightened, locking the rod in place
- Works with slightly damaged threads and minor burrs on the threaded rod
- Conforms with Federal Specification WW-H-171 (Type 23), Manufacturers Standardization Society ANSI/MSS-SP-58 (Type 19 and 23)

Fast, easy solution for attaching threaded rod assemblies to metal beam structures.



ROD LOCK BEAM CLAMP

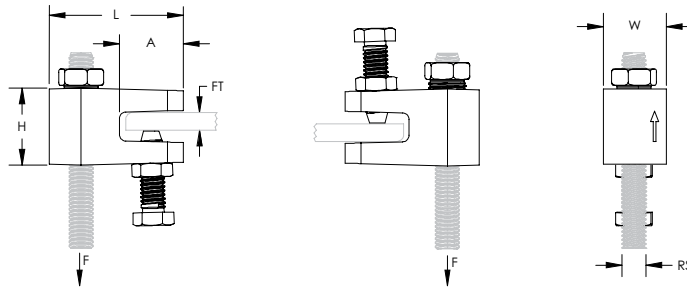

Material: Cast Iron
Finish: Electrogalvanized



Part Number	Article Number	Rod Size RS	Flange Thickness FT	Height H	Length L	Width W	A	Static Load 1 F1	Static Load 2 F2
CRLBM8EG	390001	M8	3 – 10 mm	30 mm	52.3 mm	25.3 mm	24.9 mm	1,100 N	1,400 N
CRLBM10EG	390002	M10	3 – 10 mm	30 mm	52.3 mm	25.3 mm	24.9 mm	1,100 N	2,200 N

Static Load 1 represents 1/8" to 3/16" (3 mm to 5 mm) flange thickness. Static Load 2 represents 1/4" to 3/8" (6 mm to 10 mm) flange thickness.

ROD LOCK BEAM CLAMP, THICK FLANGE

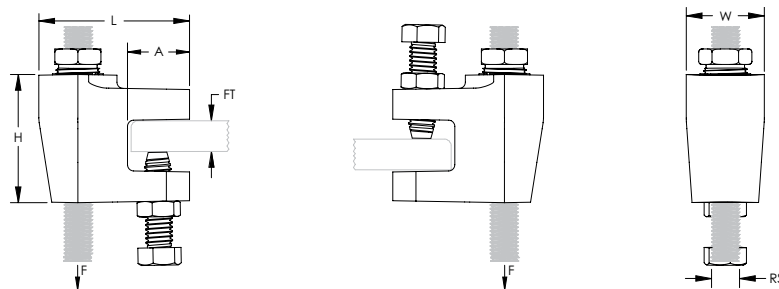

Material: Cast Iron
Finish: Electrogalvanized



Part Number	Article Number	Rod Size RS	Flange Thickness FT	Height H	Length L	Width W	A	Static Load 2 F2
CRLBM12EG	390023	M12	9.5 – 20.0 mm	53.3 mm	61.6 mm	33 mm	25.4 mm	4,400 N

FM® Approved in the bottom mount orientation only.

“I would never buy a normal beam clamp again after seeing this. It is so much faster to install this.”

Sean Daley - Total Electric
(United States)

Rod Lock Anchor Screw

- For use with concrete and solid brick
- Prefabricated assemblies easily lift and lock into place, helping to save time and money
- Works with slightly damaged threads and minor burrs on the threaded rod

Push-to-install threaded rod support for concrete or brick.

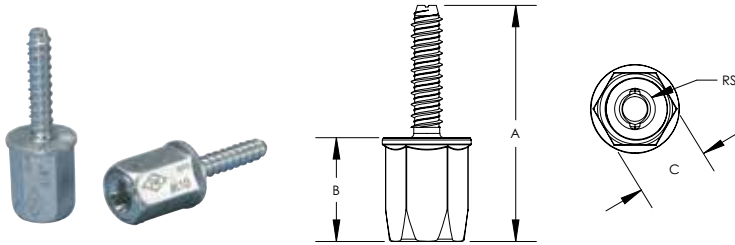

Material: Steel
Finish: Electrogalvanized



Part Number	Article Number	Rod Size RS	A	B	C	Drill Bit Diameter	Drill Hole Depth	Static Load F	Certifications
CRLAM8EG	390009	M8	72 mm	32 mm	22 mm	8 mm	50 mm	2,900 N	-
CRLAM10EG	390010	M10	72 mm	32 mm	22 mm	8 mm	50 mm	2,900 N	FM

Tested in 3000 psi (20.67 MPa) concrete.

Rod Lock L-Bracket

- Easy "push-to-install" design allows installers to simply push the threaded rod through the mounting hole, instantly holding it in position
- Prefabricated assemblies easily lift and lock into place, helping to save time and money
- Multiple attachment holes support the use of either self-drilling screws or bolts, offering installation options for concrete, wood, and steel structures
- Lock nut can be finger tightened, locking the rod in place
- Integrated adjustment nut enables fine tuning the system height up or down
- Extremely useful in tight spaces where wrenches are difficult to use
- Conforms with Federal Specification WW-H-171 (Type 23), Manufacturers Standardization Society ANSI/MSS-SP-58 (Type 19 and 23)

A versatile solution that can be used as a **Structural Attachment** or as a **Load Attachment**:

- At Structure - Attach to concrete/wood beam or to a wall
- At Load - Attach to the side of cable ladder, perforated tray, prefabricated modules, etc.

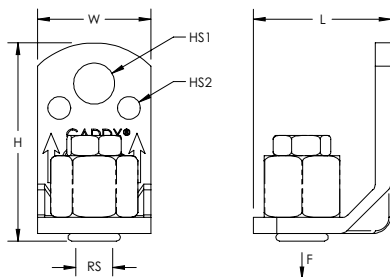

Material: Steel
Finish: Electrogalvanized



Part Number	Article Number	Rod Size RS	H (mm)	L (mm)	W (mm)	HS1 (mm)	HS2 (mm)	Wrench Size (mm)	F (N)	Certifications
CRLLM8EG	390011	M8	61.3	43.2	35.6	10.4	7.1	24	2,200	VdS
CRLLM10EG	390012	M10	61.3	43.2	35.6	10.4	7.1	24	3,100	cULus, FM, VdS

Follow fastener manufacturer's recommended shear and pull-out strength when fastening to the structure. Fastener not included. Install in accordance with applicable code.

Rod Lock Coupler

- Joins two sections of threaded rod by an easy “push-to-install” mechanism
- Can be easily installed at the end of a threaded rod, or to any existing male thread
- Plastic protection cap prevents dirt or structural coatings from obstructing the “push-to-install” mechanism
- Prefabricated assemblies easily lift and lock into place, helping to save time and money
- Works with slightly damaged threads and minor burrs on the threaded rod

Material: Steel
 Finish: Electrogalvanized
 Static Load Safety Factor: 3.5:1

An ideal replacement for traditional threaded rod couplers in applications where traditional Rod Lock structural attachments are unsuitable due to the application of structural coatings that would obstruct the push-to-install mechanism.



Part Number	Article Number	Rod Size RS	Height H	Wrench Size 1	Wrench Size 2	Static Load F
CRLCM8EG	390053	M8	60 mm	13 mm	24 mm	2,600 N
CRLCM10EG	390054	M10	60 mm	13 mm	24 mm	4,400 N

Wrench Size 1 represents hex size used to tighten to threaded rod from structure. Wrench Size 2 represents Rod Lock hex nut size.

Rod Lock Coupler with Rod

- Easily installs into any traditional structural threaded rod attachment
- Allows simple installation of threaded rod assemblies by an easy “push-to-install” mechanism
- Plastic protection cap prevents dirt or structural coatings from obstructing the “push-to-install” mechanism
- Prefabricated assemblies easily lift and lock into place, helping to save time and money
- Works with slightly damaged threads and minor burrs on the threaded rod

Material: Steel
 Finish: Electrogalvanized
 Static Load Safety Factor: 3.5:1

A coupler attached to precut lengths of threaded rod, allowing for installation in to any traditional threaded rod attachment including beam clamps, preset concrete anchors, and post drill concrete anchors.

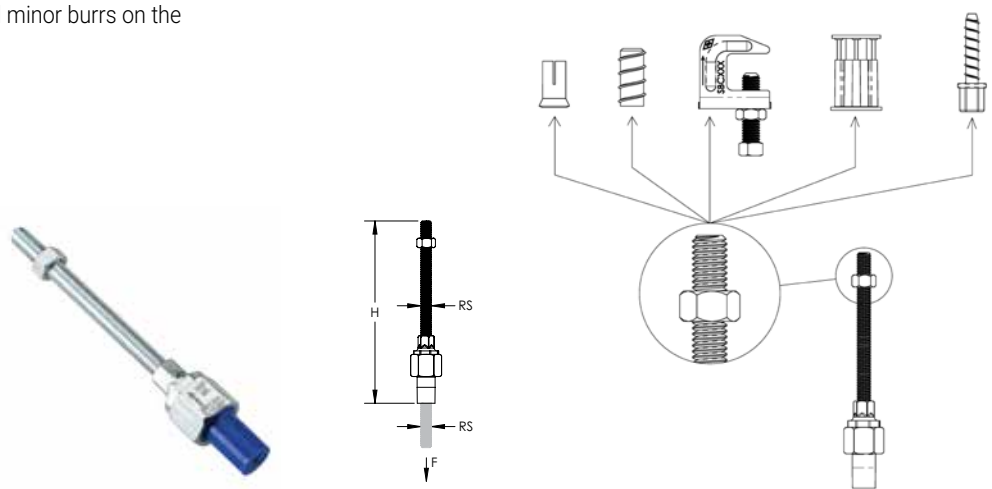

Part Number	Article Number	Rod Size RS	Height H	Wrench Size 1	Wrench Size 2	Static Load F
CRLCM8L1	390055	M8	161 mm	13 mm	24 mm	2,600 N
CRLCM10L1	390056	M10	161 mm	17 mm	24 mm	4,400 N

Wrench Size 1 represents hex nut size used to tighten to structural attachment. Wrench Size 2 represents Rod Lock hex nut size.

Rod Lock Strut

- Allows for the quick creation, installation, and adjustment of multi-level trapeze assemblies
- Ready to use out of the box and eliminates the need for cutting and preparing sections of strut
- Easy “push-to-install” design allows installers to simply push the threaded rod through the mounting hole, instantly holding it in position
- Integrated adjustment nut enables fine tuning the system height up or down
- Accommodates slight variances in rod-to-rod position of the trapeze
- No loose parts or special tools needed for installation
- Lock nut can be finger tightened, locking the rod in place
- Works with all accessories that fit standard A or C type strut channels

Prefabricated sections of strut with Rod Lock technology designed to replace traditional strut in a wide variety of applications, such as cable tray, duct, and conduit/pipe trapeze.



“Internal studies have indicated time savings of up to 69% when installing a two-tier trapeze with one person” (compared to traditional installation).

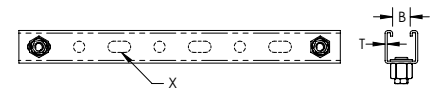
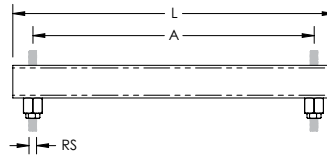

Material: Steel
Finish: Electrogalvanized; Pregalvanized

Part Number	Article Number	Rod Size RS	Length L	Thickness T	A	B	X	Ultimate Static Load F
Strut Type: A (41 x 41 mm)								
CRLP2M8L550	390031	M8	600 mm	2.5 mm	550 mm	22 mm	14 x 27 mm	7,484 N
CRLP2M8L750	390032	M8	800 mm	2.5 mm	750 mm	22 mm	14 x 27 mm	5,488 N
CRLP2M8L950	390033	M8	1,000 mm	2.5 mm	950 mm	22 mm	14 x 27 mm	4,333 N
CRLP2M8L1050	390034	M8	1,100 mm	2.5 mm	1,050 mm	22 mm	14 x 27 mm	3,920 N
CRLP2M10L550	390037	M10	600 mm	2.5 mm	550 mm	22 mm	14 x 27 mm	7,484 N
CRLP2M10L750	390038	M10	800 mm	2.5 mm	750 mm	22 mm	14 x 27 mm	5,488 N
CRLP2M10L950	390039	M10	1,000 mm	2.5 mm	950 mm	22 mm	14 x 27 mm	4,333 N
CRLP2M10L1050	390040	M10	1,100 mm	2.5 mm	1,050 mm	22 mm	14 x 27 mm	3,920 N
Strut Type: C (21 x 41 mm)								
CRLP1M8L550	390029	M8	600 mm	2.5 mm	550 mm	22 mm	14 x 27 mm	2,306 N
CRLP1M8L750	390030	M8	800 mm	2.5 mm	750 mm	22 mm	14 x 27 mm	1,307 N
CRLP1M10L550	390035	M10	600 mm	2.5 mm	550 mm	22 mm	14 x 27 mm	2,306 N
CRLP1M10L750	390036	M10	800 mm	2.5 mm	750 mm	22 mm	14 x 27 mm	1,307 N

Ultimate load ratings for nVent CADDY Rod Lock Strut assumes a uniformly distributed load and includes a hole factor of 0.92. It is based on the material yield and maximum allowable deflection; an additional Safety Factor of 2 is recommended.

nVent CADDY Rod Lock Strut must be installed with the open side of the channel facing up.

For indoor applications only.

“Using Rod Lock products on a large bus bar installation did not only significantly reduce our installation time, it also improved safety by making installation easier in hard to reach places.”

Rod Lock Telescoping Strut Replacement

- Easy "push-to-install" design allows installers to simply push the threaded rod through the mounting hole, instantly holding it in position
- Telescopes to the desired length and is locked in place by snapping closed a spring retainer clip
- Standard strut profile runs the entire length of the part, allowing most standard fittings to be placed anywhere between the rods
- Allows installers to prefabricate complex assemblies and quickly lift and lock them into place
- Lock nut can be finger tightened, locking the rod in place
- Allows for the quick creation, installation, and adjustment of multi-level trapeze assemblies
- Captive threaded nuts enable fastening to threaded rod supports without loose parts
- Integrated ruler displays space between hanger rods in inches and centimeters
- Supports up to six 2" (50 DN) conduits, six 2" (50 DN) water filled pipes at 10' (3 m) spacing, or up to 18" (450 mm) cable tray
- Conduit can be supported on the top and bottom, eliminating the need for double sided strut
- Conduit and pipe can be placed directly on the strut profile, saving vertical space in buildings with limited room for installation

Extremely fast and simple solution for multi-tiered trapeze installations. The Telescoping Strut Replacement is compatible with all of your favorite strut accessories.

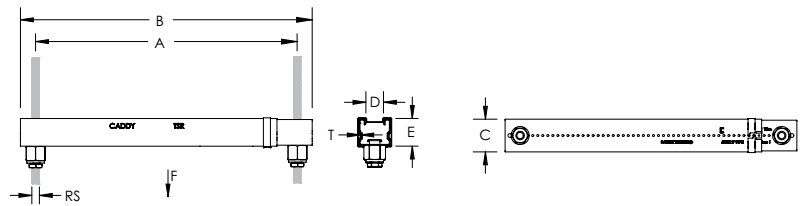

Material: Steel
Finish: Pregalvanized

Part Number	Article Number	Rod Size RS	Thickness T	A	B	C	D	E	Static Load 1 F1	Static Load 2 F2
TSR3050M8RL	390105	M8	1 mm	318 - 508 mm	356 - 546 mm	41 mm	22.2 mm	35 mm	1,330 N	880 N
TSR3050M10RL	390106	M10	1 mm	318 - 508 mm	356 - 546 mm	41 mm	22.2 mm	35 mm	1,330 N	880 N

Static Load 1 represents a distributed load for 12" - 20" (300 - 500 mm) installations and a point load for 12" - 16" (300 - 400 mm) installations. Static Load 2 represents a point load for 16" - 20" (400 - 500 mm) installations.

ALSO AVAILABLE:



nVent CADDY Cushion Clamp Insulated Strut Clamp for Pipe/Tube

- Fits into open side of strut channel
- Plastic cushion is hinged to spread apart for easy installation
- Reduces noise and absorbs shock by gripping the pipe/tube firmly
- Square neck of carriage bolt prevents over-tightening
- Nylon locknut prevents loosening under vibration

Outer Diameter (OD)	6.3 mm - 114.3 mm
Copper Tube Size	1/4" - 4"
Pipe Size	1/4" - 4"
NB/DN	8 - 100



Rod Lock Channel Nut

- Provides fast universal attachment of threaded rod and hardware to standard strut profiles
- Can be used to prefabricate assemblies which can be quickly pushed onto previously installed threaded rods
- Works with slightly damaged threads and minor burrs on the threaded rod

Simple solution for multi-tiered trapeze installations or wall mount strut applications. Designed for open-side-up or open-side-down strut configurations

■ **“Rod Lock Channel Nut** ■
is inserted into the strut,
and once on-site, we lift the
racks in place with some
expected labor savings.
The entire project includes
about 350 racks of pipe.”

Will Vranich - Smith & Oby
 (United States)

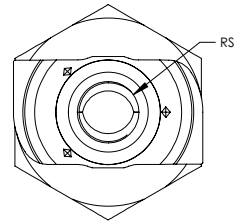
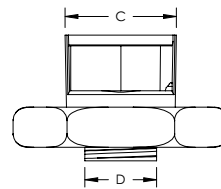
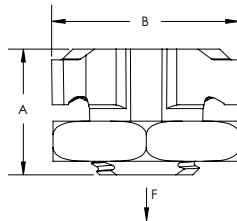

Material: Cast Iron
 Finish: Electrogalvanized

Part Number	Article Number	Rod Size RS	A	B	C	D	Static Load F
CRLSM8EG	390003	M8	23 mm	35 mm	19.5 mm	13.5 mm	2,750 N
CRLSM10EG	390004	M10	23 mm	35 mm	19.5 mm	13.5 mm	3,750 N

Rod Lock Wire Basket Support Clip

- Allows wire basket to be suspended from threaded rod without the need of a strut trapeze
- Easy “push-to-install” design allows installers to simply push the threaded rod through the mounting hole, instantly holding it in position
- Securing fingers provides superior stability, preventing damage to the cables in the basket
- Allows for pre-fabrication off site

Material: Spring Steel; Steel
 Finish: nVent CADDY Armour; Electrogalvanized

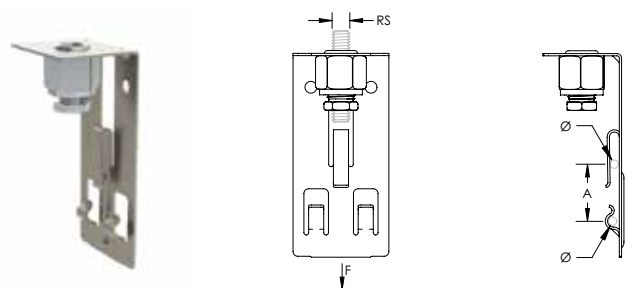

Part Number	Article Number	Rod Size RS	Diameter Ø	A	Static Load F
WBSM8RL	182016	M8	3.5 – 6.0 mm	24 – 32 mm	530 N
WBSM10RL	182018	M10	3.5 – 6.0 mm	24 – 32 mm	530 N

SN Series Nut

- Allows side mounting of nut to threaded rod
- Reduces the need for threading compared to standard nuts and washers
- Ideal for retrofit projects, such as trapeze installations, where disassembly of the support system is not desired
- Works with slightly damaged threads and minor burrs on the threaded rod
- Reduces installation time up to 50%

Innovative slotted design allows side mounting of the nut to threaded rod. Ideal for retrofit projects.

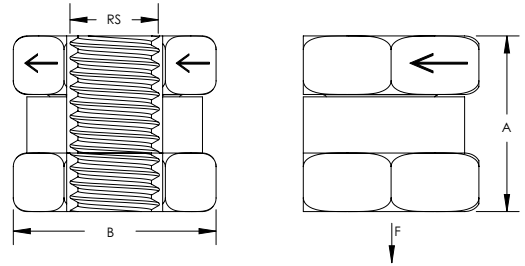
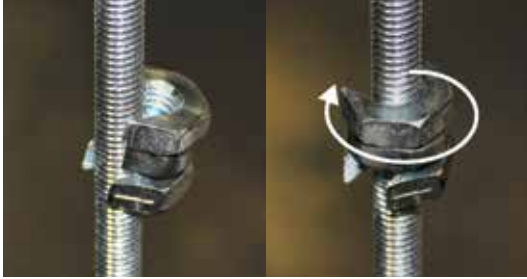

Material: Cast Iron
Finish: Electrogalvanized

Part Number	Rod Size RS	Rod Size RS	A	B	Static Load F
SNM6	390005	M6	14 mm	16 mm	1,650 N
SNM8	390006	M8	19 mm	19 mm	4,500 N
SNM10	390007	M10	19 mm	19 mm	6,000 N
SNM12	390008	M12	23 mm	25 mm	10,000 N

For use on plain and electro zinc plated hardware only.



Material: Steel
Finish: Electrogalvanized

ALSO AVAILABLE:

Strut Trapeze Attachment Plate

- Creates fast install trapeze brackets
- Includes hex bolt and strut nut

Part Number	Article Number	Rod Size
ISSP	190800	M6, M8, M10

SNSW Flanged Nut

- Ideal for retrofit projects, such as trapeze installations, where disassembly of the support system is not desired
- Use as a stopper when installing Rod Lock assemblies
- Can be easily installed, removed, and repositioned at any location along the threaded rod
- Ready to use out of the box and eliminates multiple pieces of standard hardware
- Functions as a hex nut and flat washer combined
- Washer is wide enough to work with standard strut channel profiles

A combination of a slotted channel washer and nut that can be installed at any location along a threaded rod. Ideal for retrofit project where disassembly of the existing trapeze is not desired.

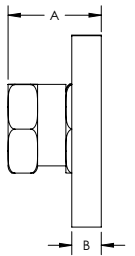
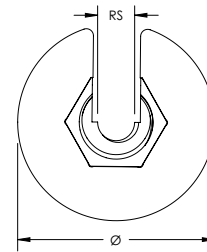

Material: Steel
 Finish: Electrogalvanized
 Static Load Safety Factor: 3:1

Part Number	Article Number	Rod Size RS	Diameter Ø	A	B	Wrench Size	Static Load F
SNSWM8	390101	M8	42.4 mm	20 mm	6.5 mm	19 mm	1,557 N
SNSWM10	390102	M10	42.4 mm	20 mm	6.5 mm	20 mm	1,557 N

For use on plain and electro zinc plated hardware only.

ALSO AVAILABLE:



WIRE BASKET TRAY CLIP

- Attaches wire basket tray to strut without additional hardware
- No tools required

Material: Spring Steel
 Finish: Armour

Part Number	Article Number	Wire Size
KBT	170011	4-8 mm

Use two clips per strut support for trays up to 12" (300 mm). Use three clips per strut support for trays up to 18" (457 mm) and add one clip per strut support for each additional 6" (150 mm) of tray width.

No load rating, for positioning only.



Our powerful portfolio of brands:

CADDY ERICO HOFFMAN RAYCHEM SCHROFF TRACER



[nVent.com/CADDY](https://www.nVent.com/CADDY)