

nVent CADDY Speed Link Manual

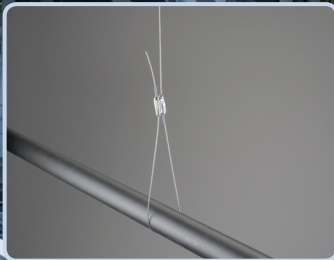

SLK LOCKING DEVICE

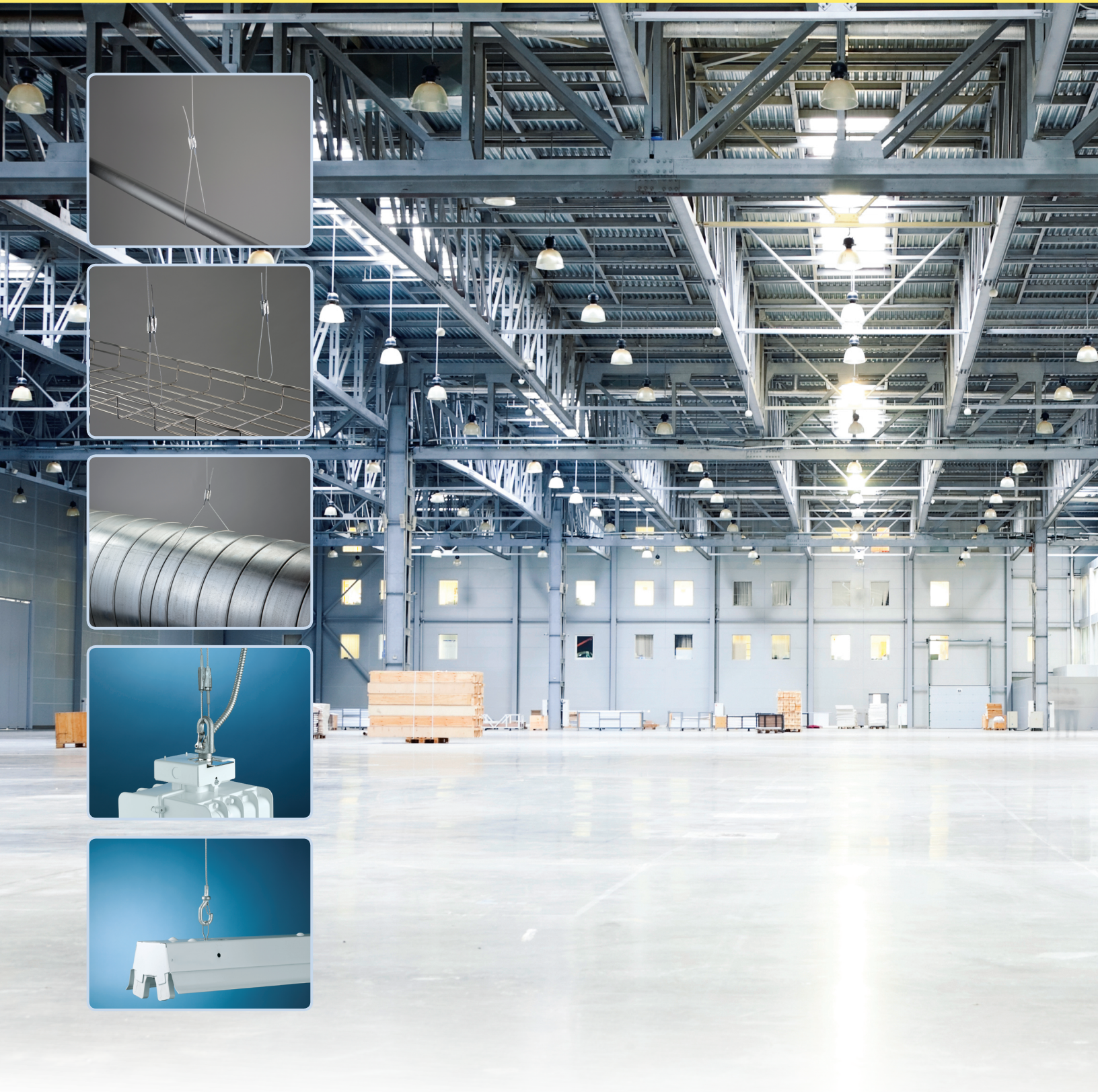

CONTENTS

1. Wire Rope Support Overview.....	3
A. Using Wire Rope.....	3
B. The Speed Link Manual.....	3
C. SLK Features.....	4
D. SLK Mechanism.....	5
2. Typical Speed Link Installation.....	6
A. Installation.....	6
B. Adjustment.....	7
C. Examples.....	8
D. Installation tips.....	11
3. Special Applications.....	13
A. Splicing.....	13
B. Minimum Bending Radius.....	15
4. Visibility / Angle Schematic.....	16
A. Visibility.....	16
B. Angle.....	17
5. Speed Link Certifications and Listings.....	19
6. Additional Warnings and Safety Instructions.....	20

1. Wire Rope Support Overview

A. Using Wire Rope

Wire rope support systems are beneficial because they are flexible, adaptable, and lightweight. The nVent CADDY Speed Link Universal Support System offers an extensive line of products designed to be the most effective wire rope support solution on the market. However, in order to reap the unique benefits of the system, it is important to select the correct locking device and end fitting for any project.

Speed Link has two main tool-free locking devices: the SLK and the SLS. The SLS locking device is best suited for use in trapeze applications with strut, C-channel, signage, and HVAC units. The SLK is a double-barreled locking device that holds the wire in each direction. It can be wrapped around structures or loads (or both at the same time) or arranged in a splice or infinite loop. Consult nVent.com/CADDY for more information on each locking device.

B. The Speed Link Manual

In this document, you will find a detailed description of the Speed Link SLK locking device, what it has to offer and the best method for installation for each type of cable management system as well as a detailed breakdown of unique benefits associated with each method, images, diagrams and a basic step-by-step installation process.

This document is one part of a series of Speed Link Manuals designed around specific products and applications. Although this document focuses specifically on different cable pathway applications, several other resources are available under the "Documents" tab on a Speed Link product page on nVent.com/CADDY. The documents are always being updated, and new sections are continuously being released.

For more information on specific products or view the other sections of the Speed Link Manual, visit nVent.com/CADDY.

1. Wire Rope Support Overview

C. SLK Features

The locking device is the piece of hardware that holds the wire loop in place. The Speed Link SLK locking device is designed to be the safest, most aesthetical, and easiest locking device on the market. The guide below shows several of the product's innovative features and the overall goal of each one.

SAFETY FEATURES

Keyless release tubes are designed to allow safe and easy adjustment, even while wearing bulky gloves

AESTHETICAL FEATURES

Low-profile locking device provides a positive aesthetic to a finished project

EASE OF USE FEATURES

Arrows on the device clearly demonstrate the correct direction to push the wire

Two jaws grip the wire inside the device, holding the wire more securely than single-cam devices common among most competitors. This rare gripping mechanism allows it to be used in unique applications such as splicing / joining 2 wires, infinite loop etc.

Speed Link is lighter, faster to install, easier to transport and generates less waste than alternative hanging methods

UL Listing on all 11 end-fittings for pre-cut lengths, SMACNA approved for Hook and Loop end-fittings. Intertek Load Test report available upon request.

Available in pre-cut lengths with 11 end-fittings or in bulk with spools of wire to adapt to the end-users' needs and applications

The color of the line corresponds to the larger goal of each feature:

SAFETY FEATURES

AESTHETICAL FEATURES

EASE OF USE FEATURES



Two tool-free locking devices are available for three wire sizes

- SLK2 compatible with 1.5mm and 2mm wire
- SLK3 compatible with 3mm wire

The locking device can accommodate wire rope at up to 90 degrees, allowing it to be positioned closer to the load than other locking devices on the market, hiding it from view and creating a much more aesthetically pleasing installation.

1. Wire Rope Support Overview

D. SLK Mechanism

The locking device is the piece of hardware that holds the wire loop in place. Locking devices may look or install differently based on the manufacturer. For example, some locking devices are sold with small tools called “keys” that unlock or free the cable. Other locking devices may be keyless and simply require a manual manipulation to move the cable through it. Much like the cable, locking devices have their own static load rating. The load rating can be different than that of the cable or end fitting, and installers should default on the lowest in the load path.

Inside the locking device, the wire is typically gripped with one or two spring loaded cams or jaws that hold the wire in place. A single-cam device holds the wire by pressing it into the inside wall of the housing. A double-jaw device holds the wire by clamping it between two spring loaded jaws. Double-jaw devices are designed to have a stronger grip on the wire than single-cam devices.

Speed Link locking device combines all the best options:

- Double-jaw design for better performance
- Push/pull keyless release allows easy adjustments
- Keyless release tubes are easy to operate while wearing bulky protective gloves
- Release tubes cannot be disengaged by mistake as opposed to other release mechanisms
- Low-profile locking device minimizes visual impact
- Cable spread of 90 degrees allows positioning the device closer to the load*
- Double-sided locking mechanism enables simple height adjustment

Material: Steel; Polypropylene; Zinc Alloy

Wire Rope Diameter (mm)	Static Load		Locking Device
1.5	44 lbs.	195 N	SLK2
2	160 lbs.	440 N	
3	350 lbs.	880 N	SLK3

* For more information on cable spread, refer to page 16.



2. Typical Speed Link SLK Installation

A. Installation

Installation of Speed Link is quick and easy.

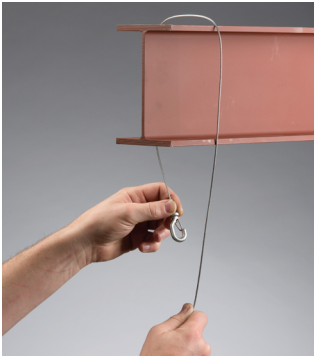

STEP 1: Clip Speed Link hook into hole of nVent CADDY Fastener or wrap around a beam, strut, etc.



STEP 2: Insert wire rope into locking device.



STEP 3: Attach wire rope to load.

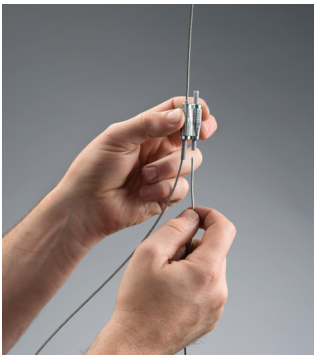

STEP 4: Insert wire rope back into locking device.

STEP 5: (If necessary) Adjust by pulling on the plastic release tubes.

2. Typical Speed Link SLK Installation

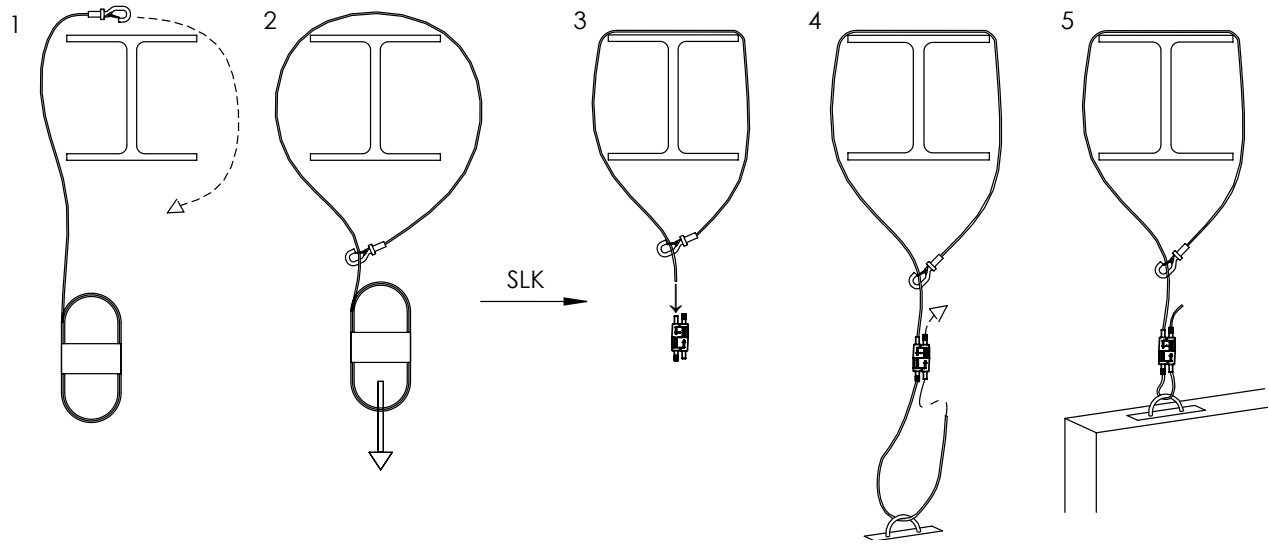

The process illustrated above shows proper installation when wrapping Speed Link with a Hook End-Fitting around a beam. Installing Speed Link this way will allow the installer to have the height adjustability at the load (easier than having it at the structure).

B. Adjustment

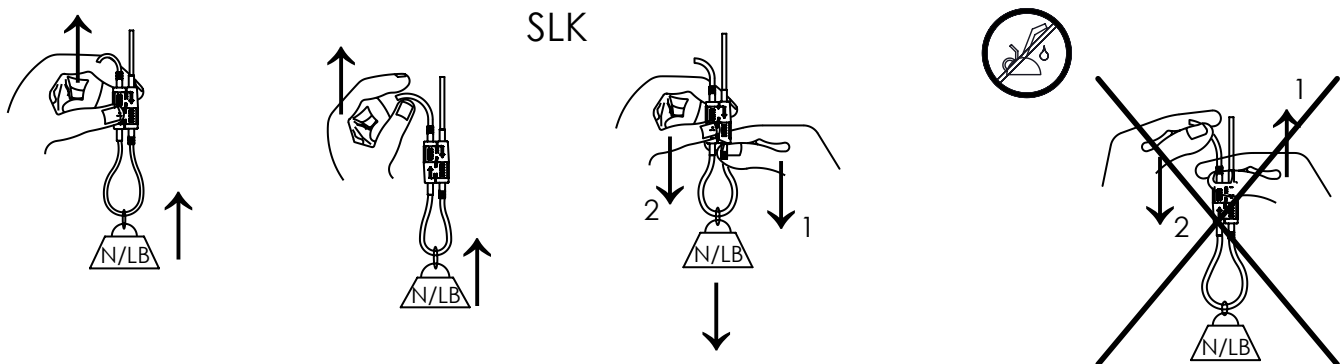

Adjustment up can be made by:

1. pulling the free end of the cable up through the locking device
2. raising the locking device on the loaded wire.

Adjustment down is made by supporting the load, gripping the device, releasing the loaded cable side release tube, and lowering the device.

2. Typical Speed Link SLK Installation

C. Examples

i. Beam Clamp

A variety of nVent CADDY Beam Clamps may be used to attach the Speed Link system.



ii. "C" and "Z" Purlin Clips

nVent CADDY Purlin Clips can be easily installed with the nVent CADDY VAFT tool from the ground.



iii. Eyebolts

Wood screw and machine-thread eyebolts will serve as an anchor for Speed Link.



iv. HangerMate®

The HangerMate anchors may be used to attach the Speed Link system.



v. Easy Strut Clip (ESC)

The nVent CADDY Easy Strut Clip provides a "portable hole" along strut runs for attachment of the Speed Link hook.



vi. Without Fasteners

The Speed Link wire rope can be looped around any structure/substructure using the loop or hook end-fittings or using the Speed Link locking device.



2. Typical Speed Link SLK Installation

vii. Cable Tray

Speed Link can be attached to cable tray (solid and ventilated tray, ladder tray, center rail tray and wire basket).



viii. Lighting and Luminaires

Lighting fixtures (luminaires) are ideal applications for Speed Link.



ix. Plumbing

Speed Link speeds up the installation of compressed air piping, water and gas pipes.



x. HVAC

Speed Link puts an end to time-consuming strap hanging of duct.

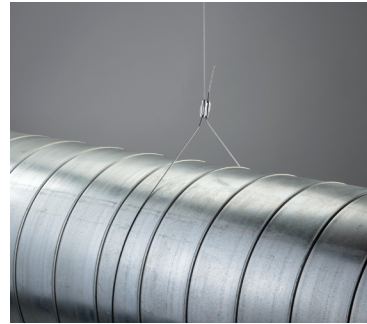

xi. Signage

Riggers have just discovered the ideal system to suspend signage: Speed Link.



2. Typical Speed Link SLK Installation

Speed Link attaches to structure differently depending on the end type. For fittings that attach at the load, the wire is looped around the structure and fed through the locking device. When end fittings attach at the structure, like the loop or toggle end fitting, the locking device is on the load side of the wire.

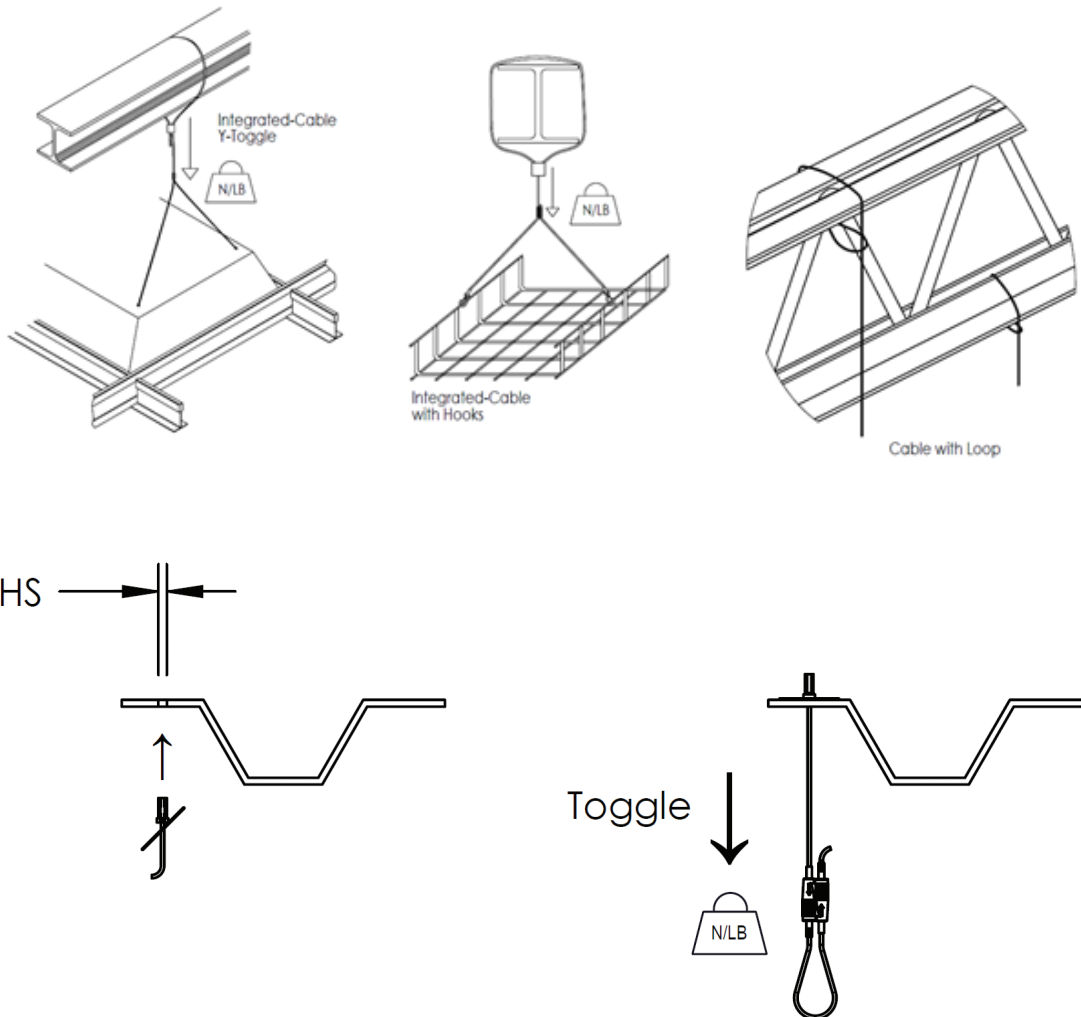

2. Typical Speed Link SLK Installation

D. Installation Tips

i. Adjustment for Concealment

For a locking device installed above a load in the standard choker-style arrangement, the device can be easily adjusted down close to the load without changing the elevation of the suspended load.

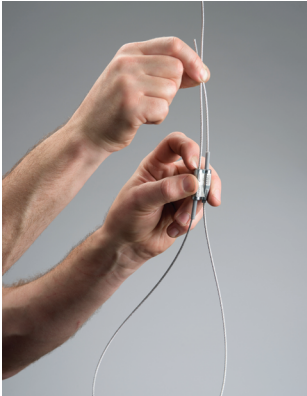

STEP 1: Pinch the free end of the cable against the loaded cable above the locking device. This will provide a temporary support for the load and hold the position of the cable. Meanwhile, grip the locking device firmly and push down on the release tube on the loaded side of the cable.

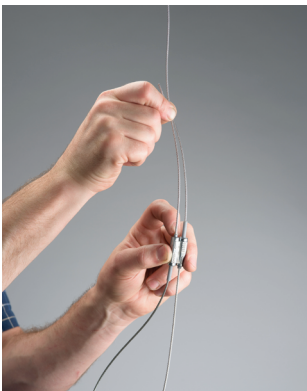

STEP 2: Slide the locking device down the cable to a position closer to the load.



STEP 3: Let go of the release tube to allow the locking device to secure to the cable.

2. Typical Speed Link SLK Installation

ii. Increasing Safety Factor

To determine the system working load: The max working load is determined by the component with the lowest allowable working load.

To determine the system working load with a single safety factor: In some cases, the hanging system will be made up of components with a variety of safety factors, working loads, and/or ultimate loads. It may be convenient to convert the working loads of all components to a safety factor of 5. This allows the minimum working load with safety factor 5 to be determined.

For components with safety factor other than 5: multiply the working load by the given safety factor. Divide the result by 5. This gives the working load at safety factor 5. For components with ultimate load only: divide the ultimate load by 5. It is recommended to round down to find the working load at safety factor 5. Once the working load at safety factor 5 is found for each component, those loads can be compared to the Speed Link working loads to determine the limiting component for the system working load at safety factor 5.

Increase the safety factor by reducing the working load. For some applications (e.g., theater stages), a larger safety factor may be required. The formula is:

Reduced Working Load=Maximum Working Load×5/Required Safety Factor

The Required Safety Factor must be ≥ 5

Example: If the Required Safety Factor is 10, then the Reduced Working Load for a 2 mm wire rope is 50 lbs. [222 N] instead of the Maximum Working Load of 100 lbs. [444 N]

3. Special Applications

A. Splicing

i. Introduction to Splicing

Extend the available cable lengths, or create a cable assembly with integral attachments at both ends, by joining two Speed Link wire ropes with a locking device.

By inserting two cables into the locking device, as shown below, they can be joined to create new combinations of lengths and end fittings.

An example of a splicing application is combining a cable with a Y-hook end and a cable with a toggle end. The Y-hook can be connected to two sides of a light or cable tray. The toggle can be inserted into a hole on a metal deck ceiling. The locking device, placed in the middle, splices the two cables together and provides height adjustment.

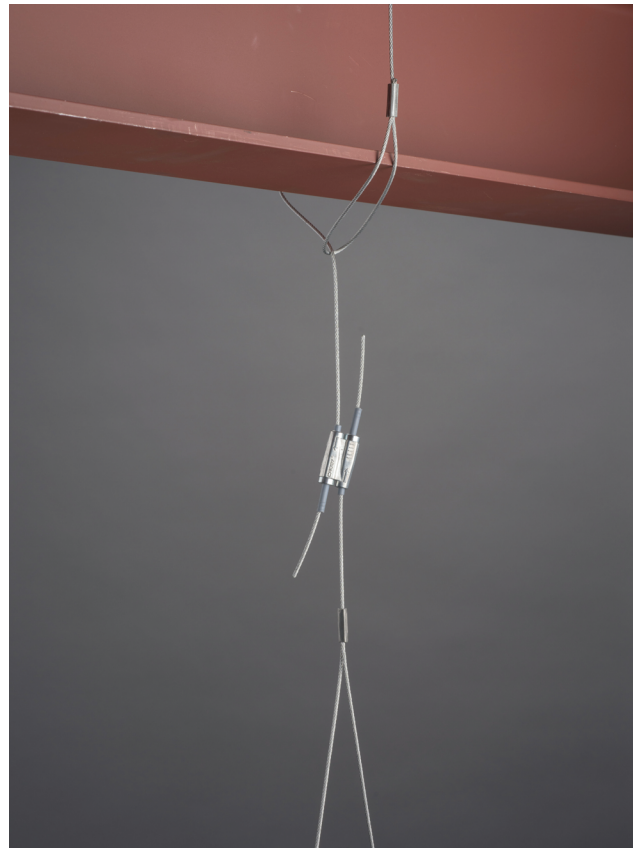

Splicing differs from normal cable hanging in that there is only one grip on each cable as opposed to the normal two grips. Because of this difference, the load rating is reduced, but maintains a safety factor of 5. See the table below for reduced working loads.

3. Special Applications

ii. Splicing Application Load Rating

Device	Wire Rope Diameter (mm)	Working Load	
SLK2	1.5	35 lbs	155 N
SLK2	2	65 lbs	290 N
SLK3	3	150 lbs	670 N

Splicing Test Results Compared to Competitor

Part No.	Cable size (mm)	Specified Load (lbs)	Ave. Load (lbs)	Min. Load (lbs)	Max Load (lbs)	Count	Ave. % of Specified Load
SLK2	2	500	414.9	398.5	437	5	83%
Competitor "G" 2	2	500	299	276	327	5	45%*

Part No.	Cable size (mm)	Specified Load (N)	Ave. Load (N)	Min. Load (N)	Max Load (N)	Count	Ave. % of Specified Load
SLK2	2	2224	1846	1773	1944	5	83%
Competitor "G" 2	2	2224	1330	1228	1455	5	45%*

Based on private testing while using the product for the splicing application.

*45% is based on manufacturer recommendation for installation.

iii. Infinite Loop Application

An infinite loop is a cable application where the cable is looped around the structure and the load; each end of the cable is inserted into the locking device. The result is a continuous loop of cable secured and adjusted by the locking device.

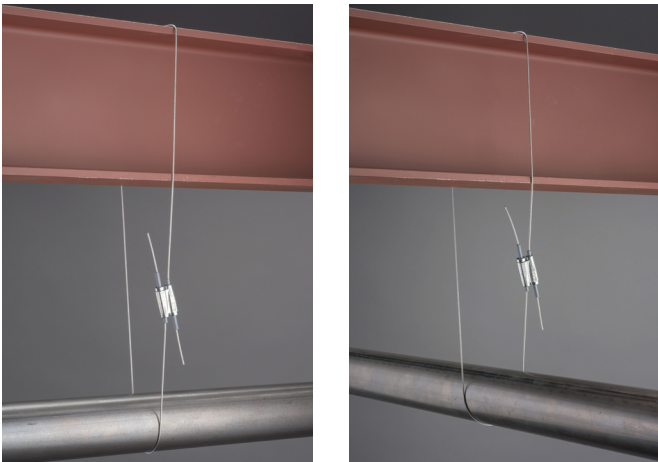

Device	Wire Rope Diameter (mm)	Working Load	
SLK2	1.5	90 lbs	400 N
SLK2	2	160 lbs	700 N
SLK3	3	350 lbs	1550 N

The infinite loop is a convenient means to hang in conditions where there is low overhead working space between the load and the ceiling.

The infinite loop is the strongest configuration of Speed Link. Because the cable is doubly supporting the load, the working loads are substantially higher than the standard installation method, yet still maintaining a safety factor of 5. See the table above for allowable working loads.

3. Special Applications

B. Minimum Bending Radius

i. 122 Application

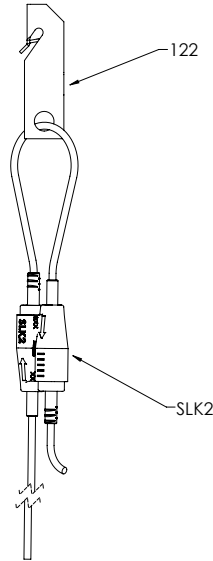

Device	Wire Diameter (mm)	Load	
SLK2	1.5	44 lbs	195 N
SLK2	2	75 lbs	330 N
SLK3	3	145 lbs	645 N

ii. 4H Application

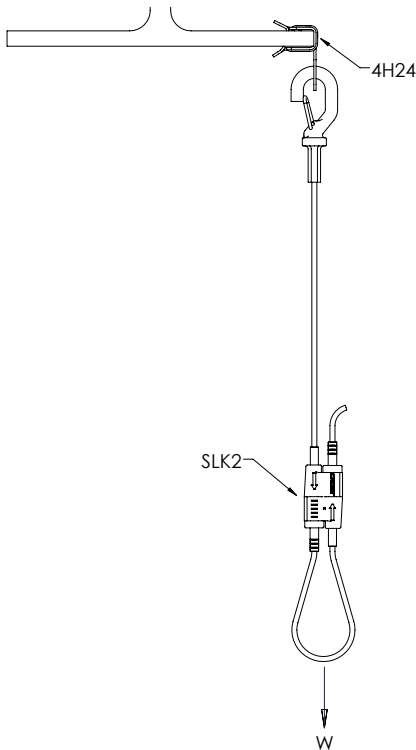

By attaching to structure with another nVent CADDY product, the height adjustment of the system is moved on the end of the rope that is closer to the load. This makes it much easier to make fine height adjustments because installers do not have to estimate the amount of rope that needs to be added or removed at the structure. It is also much easier for the installer to lift the application at the load and adjust the wire.

See calculations in the table below as an example, considering a structural attachment with a safety factor of 3:1.

Device	Wire Diameter (mm)	Maximum Ultimate Load		Load when Safety Factor = 5	
SLK2	1.5	220 lbs	978 N	44 lbs	195 N
SLK2	2	500 lbs	2224 N	100 lbs	440 N
SLK3	3	600 lbs	3600 N	120 lbs	720 N

4. Visibility / Angle Schematic

A. Visibility

Competitor "B": 39°

Competitor "G": 60°

Speed Link: 90°



Three wire rope support locking devices are installed according to manufacturer instructions.

How close a locking device can be placed to a load can be expressed in several different ways. One method is to measure the angle between the legs of cable wrapping around the load. The greater the angle, the closer the locking device is to the load. The closer the device is to the load, the less visible it is when viewed from the floor. This may be of concern in installations trying to achieve an architectural aesthetic.

What limits how great the angle between the cables under a locking device can be is the ability of the device to grip cables with additional side loads imparted from the angles. Some devices slip or break. Others release the load. Speed Link has the greatest allowable angle on the market; 90°. The patented flexible release tubes conform to the bend in the cable without unlocking the gripping jaws.

Safety: Speed Link allows a 90° spread between the cables under the locking device. This angle has been found to be a practical limit on installation for preserving working space for adjustment. It would be difficult for the installer to surpass 90° on the installation of Speed Link. Competitive devices have maximum allowable angles of 60° or even 39°. The installer could easily create a non-conforming installation and potential safety hazard if angle or distance measurements are not done carefully.

4. Visibility / Angle Schematic

B. Angle

Speed Link can provide angled support, even from sloped and vaulted ceilings. The maximum angle is 60° from the vertical axis. The working load has to be reduced depending on the angle according to the following table:

Working Load Reduction by Angle (lbs)					Working Load Reduction by Angle (N)				
Angle	Reduction by	Working Load for 1.5 mm	Working Load for 2 mm	Working Load for 3 mm	Angle	Reduction by	Working Load for 1.5 mm	Working Load for 2 mm	Working Load for 3 mm
0°	None	44	100	200	0°	None	195	440	890
15°	3%	43	97	193	15°	3%	188	425	860
30°	13%	38	87	173	30°	13%	169	381	771
45°	29%	31	71	141	45°	29%	138	311	629
60°	50%	22	50	100	60°	50%	98	220	445

In an Angled Sling-Type Installation application the working load is valid for each wire rope.

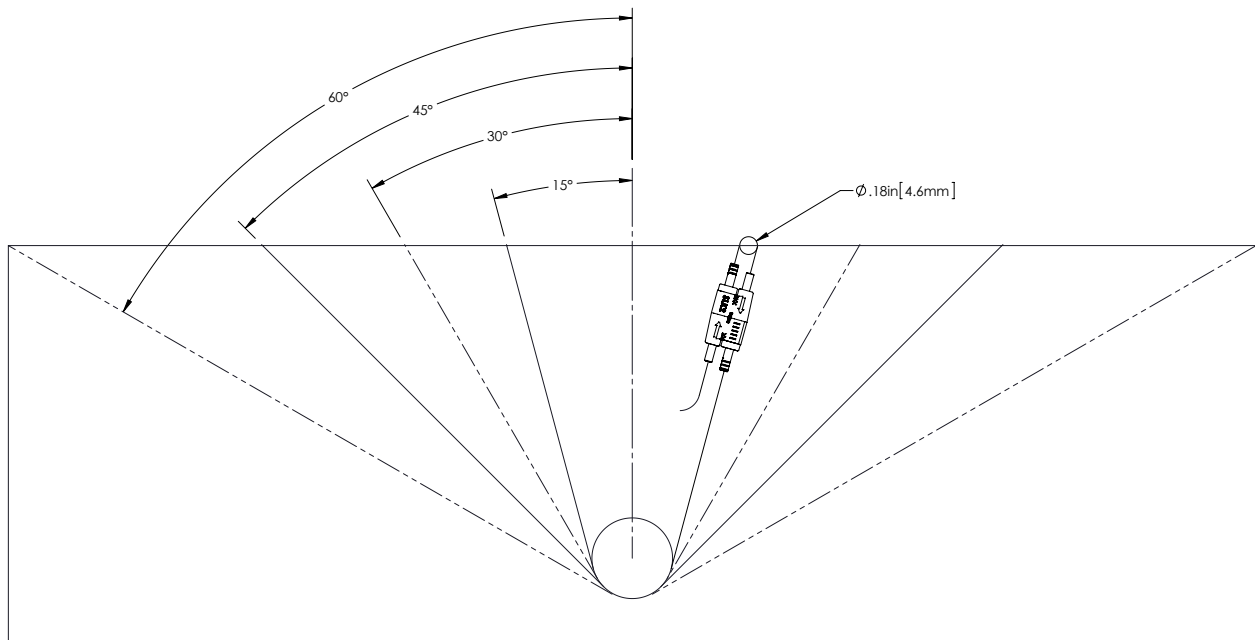

Working Load For Angled Sling-Type Installations (lbs)					
Angle	0	15	30	45	60
Load %	100%	97%	87%	71%	50%
1.5 mm	88	85	76	62	44
2.0 mm	200	193	173	141	100
3.0 mm	400	386	346	283	200
Reduced by	None	3%	13%	29%	50%

Working Load For Angled Sling-Type Installations (N)					
Angle	0	15	30	45	60
Load %	100%	97%	87%	71%	50%
1.5 mm	390	377	338	276	195
2.0 mm	880	850	762	622	440
3.0 mm	1780	1719	1542	1259	890
Reduced by	None	3%	13%	29%	50%

4. Visibility / Angle Schematic

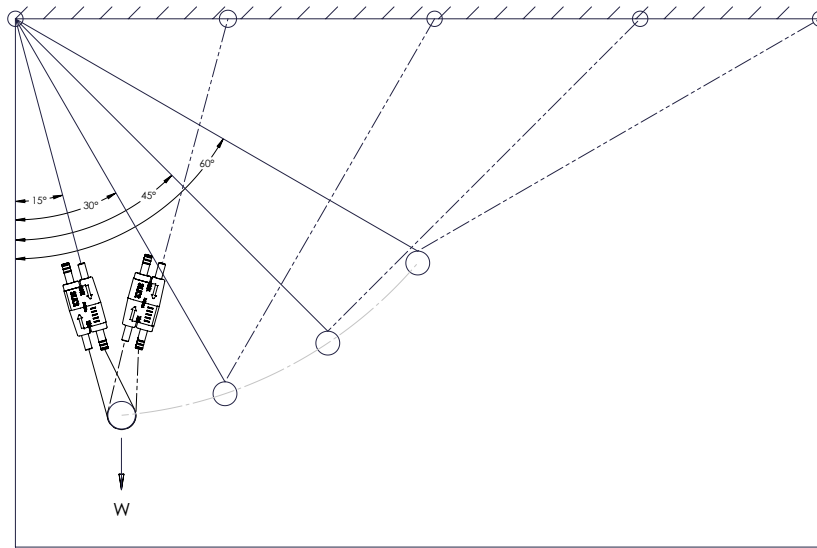

Working Load per Device For Angled Installations (lbs)					
Angle	0	15	30	45	60
Factor	1	0.97	0.87	0.71	0.50
1.5 mm	44	43	38	31	22
2.0 mm	100	97	87	71	50
3.0 mm	200	193	173	141	100
Reduced by	None	3%	13%	29%	50%

Working Load per Device For Angled Installations (N)					
Angle	0	15	30	45	60
Factor	1	0.97	0.87	0.71	0.50
1.5 mm	195	188	169	138	98
2.0 mm	440	425	381	311	220
3.0 mm	890	860	771	629	445
Reduced by	None	3%	13%	29%	50%

5. Speed Link Certificates & Listings

Speed Link is listed with UL for Cable and Conduit Supports and for Luminaires.



Speed Link has verification by SMACNA for alternatives to duct hangers.

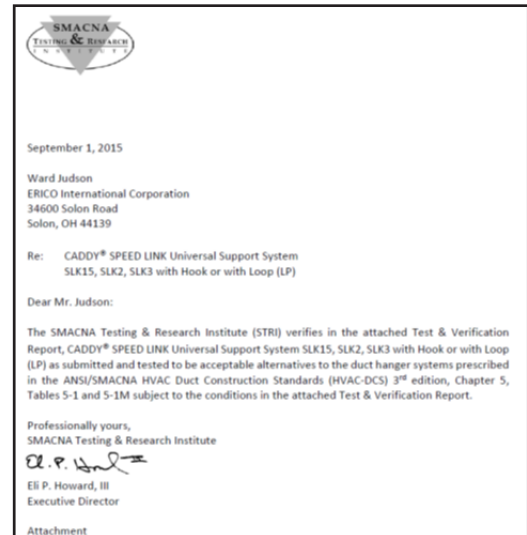

Multiple independent tests of Speed Link locking devices and accessories have been conducted by Intertek. Test reports are available upon request.



6. Additional Warnings and Safety Instructions

When using Speed Link, the following must be observed:

- Load ratings must be followed
- Load must be static and stable
- All the Speed Link components must be free of oil or any other sort of grease and lubricants
- All the Speed Link components must be free of any paint, varnish or any other coating
- Product should be installed in an indoor, non-corrosive environment



Our powerful portfolio of brands:

CADDY ERICO HOFFMAN RAYCHEM SCHROFF TRACER

WARNING: nVent products shall be installed and used only as indicated in nVent's product instruction sheets and training materials. Instruction sheets are available at nVent.com/CADDY and from your nVent customer service representative. Improper installation, misuse, misapplication or other failure to completely follow nVent's instructions and warnings may cause product malfunction, property damage, serious bodily injury and/or death, and void your warranty.

©2018 nVent. All nVent marks and logos are owned or licensed by nVent Services GmbH or its affiliates. All other trademarks are the property of their respective owners. nVent reserves the right to change specifications without notice.

CADDY-WPCS-FM1354WWWEN-SpeedLinkManual-WWEN-1805