



CONNECT AND PROTECT

# SPD Component Tester MGATESTER1

Instruction Manual

nvent

ERICO

# SURGE PROTECTION PRODUCTS

## 5 YEAR LIMITED WARRANTY

ERICO International Corporation ("ERICO") warrants its surge protection products (the "Products") to be free from defects in material and workmanship at the time such products are shipped from ERICO for a period of five (5) years from the date of manufacture. The purchaser acknowledges that lightning is a natural event with statistical variation in behavior and energy levels that may exceed product ratings, and 100% protection is not offered and cannot be provided. The purchaser acknowledges that the Products, by their nature, may be subject to degradation as a consequence of the number and severity of surges and transients that they experience in normal use, and that this limited warranty excludes such gradual or sudden degradation. ERICO in no event shall be responsible or liable under this limited warranty or otherwise unless the Products were (a) used only for the purposes for which they were designed; (b) properly installed; and (c) installed, stored and used in strict conformance with ERICO product instruction sheets, training materials, recommended procedures, applicable industry guidelines, codes and standards. Claims for defects or nonconformities ascertainable upon inspection must be made to ERICO in writing within 5 days after purchaser's receipt of the Products. All other claims must be made in writing to ERICO within 5 days after the date of their discovery by purchaser prior to the expiration of this limited warranty. Claims not made as provided above and within the applicable time period will be barred. ERICO will, in its sole discretion, repair or replace the Products it has determined do not comply with this limited warranty. ERICO excludes all liability except such liability as is directly attributable to the willful misconduct or gross negligence of ERICO employees. Should ERICO be held liable, its liability shall in no event exceed the purchase price of the Product that does not comply with this limited warranty. Except for the limited warranty set forth above, NO OTHER WARRANTY, WHETHER EXPRESS OR IMPLIED (INCLUDING ANY WARRANTY OF MERCHANTABILITY OR FITNESS FOR A PARTICULAR PURPOSE), SHALL EXIST IN CONNECTION WITH THE SALE OR USE OF THE PRODUCTS. THE FOREGOING STATES THE EXCLUSIVE REMEDY FOR ANY BREACH OF ERICO'S FIVE (5) YEAR LIMITED WARRANTY AND FOR ANY CLAIM, WHETHER SOUNDING IN CONTRACT, TORT OR NEGLIGENCE, FOR LOSS OR INJURY CAUSED BY THE SALE OR USE OF THE PRODUCTS. ERICO, IN NO EVENT, SHALL BE RESPONSIBLE FOR ANY LOSS OF BUSINESS OR PROFITS, DOWNTIME OR DELAY, LABOR, REPAIR OR MATERIAL COSTS OR ANY SIMILAR OR DISSIMILAR CONSEQUENTIAL, INCIDENTAL, SPECIAL, DIRECT OR INDIRECT LOSS OR DAMAGE. A Material Return Authorization number from ERICO is required for all returns of the Products to ERICO. ERICO shall not be responsible for any transportation charges. Return freight must be pre-paid by the purchaser. This limited warranty extends only to the purchaser of the Products from ERICO and is contingent upon written acceptance of ERICO's standard terms and conditions of sale (as amended by this 5 year limited warranty), a copy of which can be obtained at <http://www.erico.com/public/library/Terms/TermsOfSaleNA.pdf>.

Copyright 2008, 2011 ERICO International Corporation. All rights reserved.

CADDY, CADWELD, CRITEC, ERICO, ERIFLEX, ERITECH and LENTON are registered trademarks of ERICO International Corporation.

# Table of Contents

<b>SPD COMPONENT TESTER.....</b>	<b>4</b>
Introduction .....	4
<b>SAFETY .....</b>	<b>4</b>
<b>UNPACKING THE INSTRUMENT .....</b>	<b>5</b>
Indicators, Connections and Controls .....	5
<b>USER DISPLAYS, MENU STRUCTURE AND NAVIGATION .....</b>	<b>6</b>
Passcode Screen .....	6
Splash Screen.....	6
Main Screen .....	6
Log Screen .....	6
About Screen.....	7
Change Passcode Screen.....	7
Time/Date Screen.....	7
Display Screen .....	7
Measurement Screen .....	8
Options Screen.....	8
Battery Screen .....	8
MOV Screen .....	8
GDTScreen .....	9
TVSScreen .....	9
<b>USING MGATESTER1 .....</b>	<b>9</b>
Power ON.....	9
Power OFF .....	9
Restoring Factory Defaults .....	9
<b>USER COMMISSIONING.....</b>	<b>10</b>
Device Setup .....	10
Measure Setup .....	10
System Status .....	10
About MGATESTER1.....	10
Battery Monitoring.....	10
<b>MEASURING .....</b>	<b>11</b>
Auto / Manual Measurement Mode.....	11
Measuring MOVs .....	11
Measuring TVSS.....	12
Measuring GDTs.....	12
Measuring SPDs.....	12
Updating the Firmware .....	13
<b>MAINTENANCE .....</b>	<b>14</b>
Cleaning .....	14
Replacing Main Battery .....	14
Replacing Clock Battery .....	14
<b>SPECIFICATIONS.....</b>	<b>15</b>
Features .....	15
Included Accessories.....	15
General Specifications.....	15
Measurement Accuracy .....	15
Physical Dimensions .....	15

# SPD Component Tester

## INTRODUCTION

The nVent ERICO MGATESTER1 has been developed to test components commonly used in surge protective devices, such as Gas Discharge Tubes (GDT), Metal Oxide Varistors (MOV) and Transient Voltage Suppressors (TVS) diodes.

It is a portable, battery operated, instrument with integrated battery charger and housed in a robust ergonomic enclosure. The instrument features a 320x240 pixel TFT Color Display with Touch Screen user interface.

All figures show the Model MGATESTER1.

Features of the instrument include:

- Measurement of MOVs, GDTs and TVSs
- Test GDTs and MOVs up to 1500 VDC
- Ability to auto-detect type of component connected
- Display list of successive measurements using LOG Mode
- Color TFT display and touch screen interface
- Rechargeable battery

## Safety

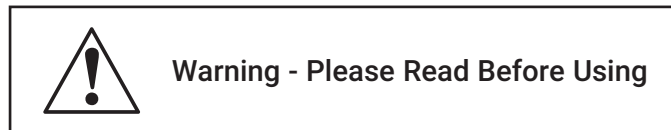

The manual shall be read for every symbol  placed on the instrument in order to find out the sort of hazard!

During measurement, the MGATESTER1 generates high voltages at the output terminals. To prevent possible electrical shock, personal injury, or the possibility of fire, it is important that the following points are carefully observed:

- Use the product only as specified.
  - Do not operate the product in the vicinity of explosive gas, vapor or in wet environments.
  - Do not use test leads if they are damaged. Examine the test leads for damaged insulation, exposed metal or wear.
  - Use only test leads supplied with the product.
  - Firstly connect the test leads to the component which is going to be tested and then to the unit.
  - When servicing the unit there is risk of electric shock due to generator of 1,5 kVdc. After repair it is necessary to check correct functioning of instrument according to the specification.
  - The unit should not be operated with the case open. Exposure to hazardous voltages is possible.
  - Keep fingers well removed from test leads or components to which the test leads are attached during measurements.
  - Recharge the batteries when the low battery indicator shows to prevent incorrect measurements
- The unit is charged by external power supply with voltage 12Vdc  $\pm$ 1,2Vdc. Input current is less than 2A. When batteries are being charged the instrument can not test SPD components.
  - Do not operate the product if it is damaged.
  - Test leads and test probes with alligator is specified. If used other types of test accessory protection by the equipment may be impaired.
  - Do not use non rechargeable batteries. Use only rechargeable battery NiMH, 1,2V, AA.
  - Have only an approved nVent ERICO technician repair the product.
  - Use only specified replacement parts.
  - Replace batteries with NiMH cells of similar mAh rating for best results.
  - Use only the approved DC power unit supplied with the product.
  - If the unit is used in a manner not specified by the manufacturer protection provided by unit can be impaired.

The unit provides double insulation between hazardous voltage and accessible parts. The clips of accessories shall not be touched during high voltage test. There is high voltage on the alligator clips when the red diode is illuminating.

# Unpacking the Instrument

The standard product is supplied with the items listed in Table 1. If the product is damaged or an item is missing, please contact the place of purchase immediately.

**Table 1. Standard Accessories:**

Description
model MGATESTER1
5 x AA Batteries, NiMH, 1.2V, 2450 mAh
12 VDC power adapter, 100 VAC - 240 VAC, 2000mA
Test lead set with alligator clips
LCD touch screen stylus



## ⚠ Firstuse

It is recommended that battery be fully charged before its use. This is accomplished by inserting the 5x AA NiMH batteries provided into the battery compartment and connecting the AC charger to the instrument for 14 hours before using the instrument. The Battery Screen provides information of the status of the MGATESTER1 battery (Ref: Battery Monitoring Section).

## INDICATORS, CONNECTIONS AND CONTROLS

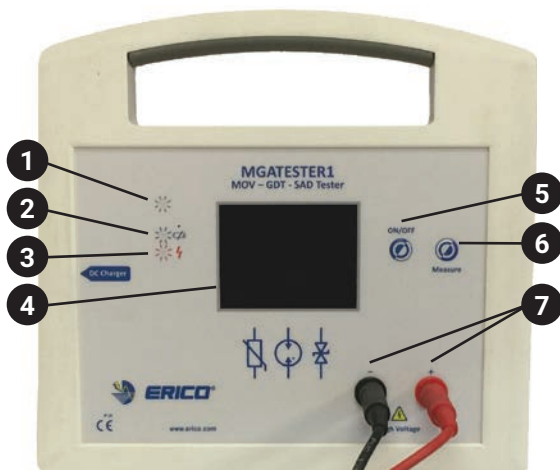

Figure 2: Front view of instrument controls.

## Legend:

1. Run Heartbeat LED (Green) - pulses to indicate instrument is alive.
2. Battery Status LED (Blue) - illuminates when battery is completely flat (< 1.12 V/cell) and requires recharging.
3. High Voltage LED (Red) - illuminates when HV is present at the output terminals during a measurement.
4. TFT LCD display with resistive touch panel.
5. ON/OFF button - short press instrument ON > short press instrument OFF. Continuous press forces instrument OFF if in a locked-up state.
6. MEASURE button - to take a measurement.
7. Output terminal connections.



**Warning: High Voltage are present at these terminals (Ref. Safety section).**



Figure 3: Rear view of instrument controls.

## Legend:

1. USB - for factory use and used during firmware update.
2. DC Power supply input - 12 VDC, 2000 mA.
3. Battery compartment - 5 x AA Batteries, NiMH, 1,2 V, 2450mAh.



**Warning: The unit is charged by external power supply (Ref. Safety section)**



**Warning: Do not use non rechargeable batteries (Ref. Safety section)**

# User Displays, Menu Structure and Navigation

## PASSCODE SCREEN

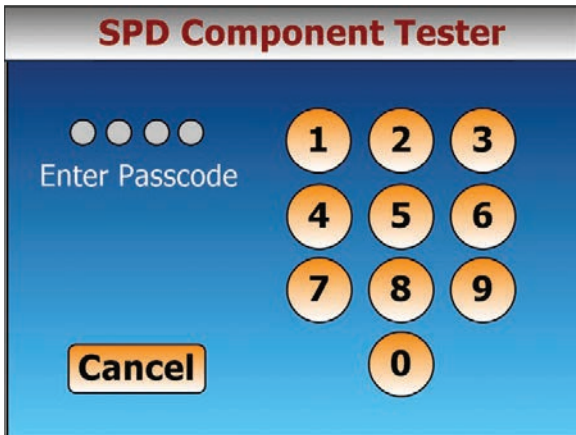

The passcode is used to unlock the instrument to prevent unauthorized use. On first use of the instrument before any User Options have been configured, the Passcode Screen is displayed to the user. The default passcode is 1\_2\_3\_4. This code can be changed in the SET- UP/ Device- Setup/Set-Passcode menu. If the passcode is forgotten, the unit can be restored to its User Commissioning state where the pass- code will be reset to the default (Ref. Restoring Factory Defaults section).

## SPLASH SCREEN

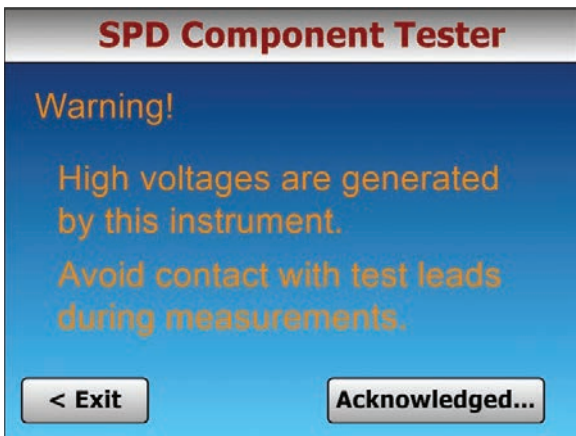

The Splash Screen is used to greet the user and provide important safety information. The user is required to read the information and by clicking the Acknowledged... button is signifying that the potential hazard is understood and that precautions indicated will be followed (Ref. Safety section).

## MAIN SCREEN

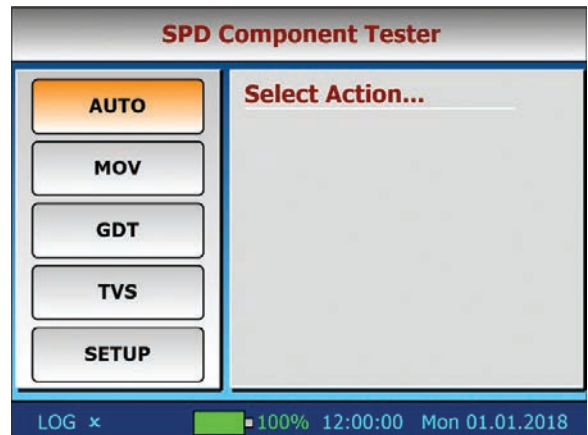

The Main Screen comprises four display panels. On the left is the Buttons panel where the user selects various actions by clicking the required button. On the right is the Output panel, where results of measurements are displayed. At the top is the Title panel, where menu navigation information is displayed, and at the bottom is the Footer panel where status information, such as the time and date, the condition of the battery, whether the AC ~ mains is plugged in, and whether the instrument is set to Log Measurement mode or not.

## LOG SCREEN

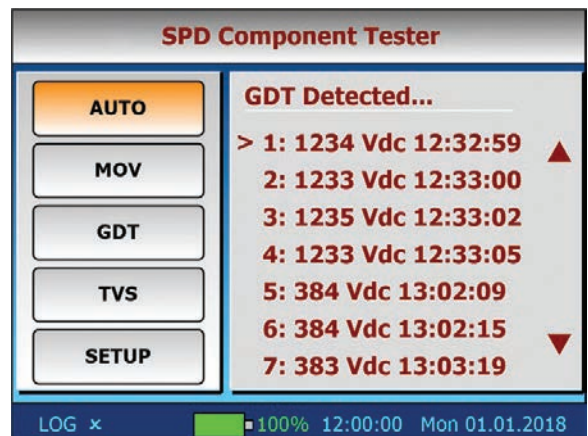

The Log Screen is displayed when the instrument is set to Log Measurement mode. This is done by clicking the LOG option in the Footer panel. A check  $\checkmark$  indicates this mode has been activated. If the LOG mode is active, the instrument will display successive measurement readings and allow the user to scroll backwards and forwards through the list. Up to 50 successive readings are logged before the list is overwritten, oldest reading first. The LOG mode is useful when the user is wishing to batch-test, or compare results between various surge protective components (SPCs) or surge protective devices (SPDs).

## ABOUT SCREEN

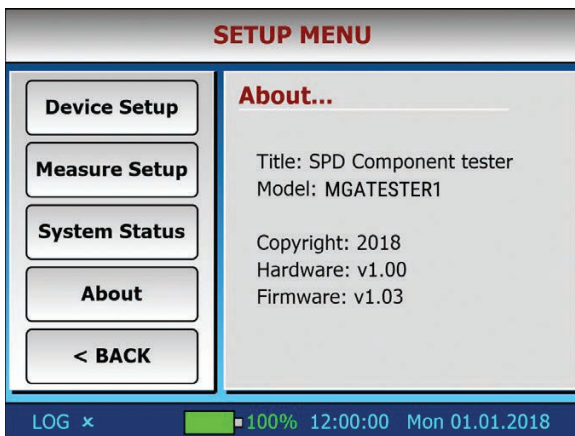

The About Screen provides information about the MGATESTER1 manufacturing build. Note: If the firmware is updated, this will be reflected in the firmware version shown.

## CHANGE PASSCODE SCREEN

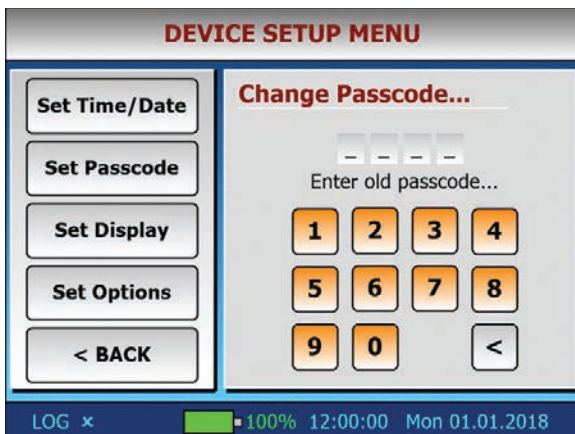

The Change Passcode Screen allows the user to change the passcode required to unlock the instrument on startup.

*Note: The requirement that a passcode be entered in order to allow access to the instrument can be turned ON or OFF in the SETUP/Device-Setup/Options menu.*

## TIME/DATE SCREEN

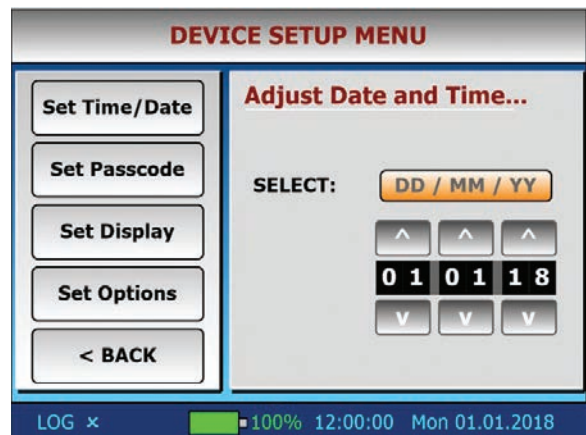

The Time/Date Screen allows the user to set the Time and Date. Start by clicking the DD/MM/YY button. This will toggle between DD/MM/YY and HH:MM:SS setting. The up/down arrows are used to adjust each digit of the time or date.

On exiting the screen, the time and date will be stored and maintained when MGATESTER1 is powered OFF.

*Note: The real time clock uses an internal battery to maintain the time and date settings. The condition of this battery is checked each time the instrument is started, and the user informed if replacement is required (Ref. Replacing RTC battery section).*

## DISPLAY SCREEN

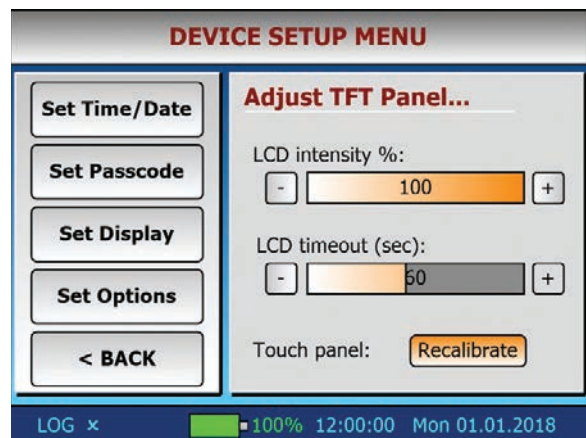

Adjustment of the TFT LCD panel settings is possible in the Display Screen. The intensity of the LCD backlight can be set between 0 - 100%.

Setting the LCD determines the time after user inactivity when the display turns OFF to conserve battery power. This can be set from 10 - 120 s. Moving the slider completely to the right turns OFF the LCD timeout function. The Recalibrate button allows the user to recalibrate the touch panel display coordinates should this become necessary.

## MEASUREMENT SCREEN

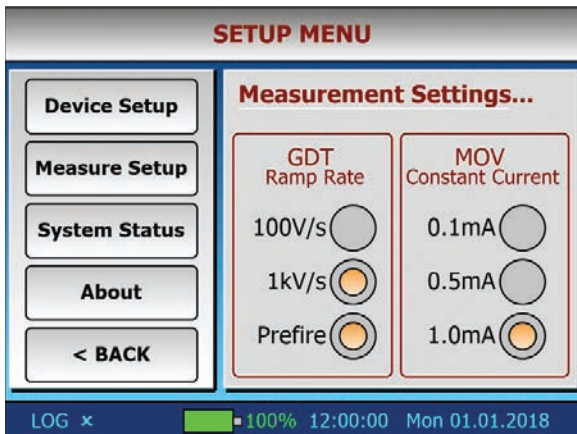

The Measurement Screen is where the user selects the rate of voltage ramp (ramp rate) used in the testing of gas discharge tubes, and the constant current used in the testing of metal oxide varistors and avalanche breakdown diodes. It is sometimes important during the measurement of GDTs to preionize the gas inside before taking a measurement. The GDT Prefire setting allows this feature to be turned ON. In this mode, the GDT will be fired three times before the measurement is recorded. These settings are retained for when the instrument is next used after a power down.

## OPTIONS SCREEN

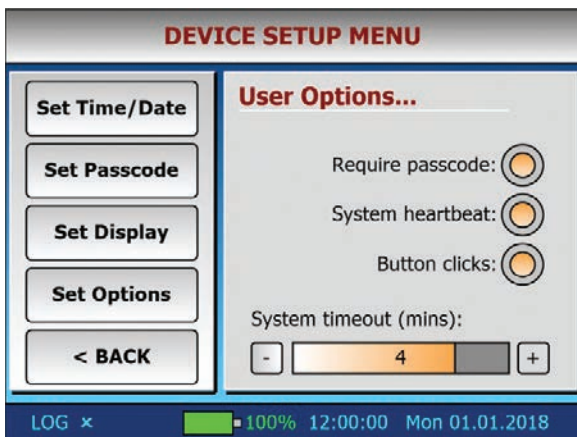

The Options Screen is where various user preferences can be configured. These include whether:

- A passcode is required to access the instrument
- The system heartbeat (blinking green LED on front of the instrument) is required
- A sound is required each time a button or control on the LCD is touched.

The System timeout slider allows the user to configure the inactivity timeout from 1 to 5 minutes in minute increments. If no button or touch control has been activated within the assigned time, the instrument will enter an automated shutdown (Ref. Power OFF section)

## BATTERY SCREEN

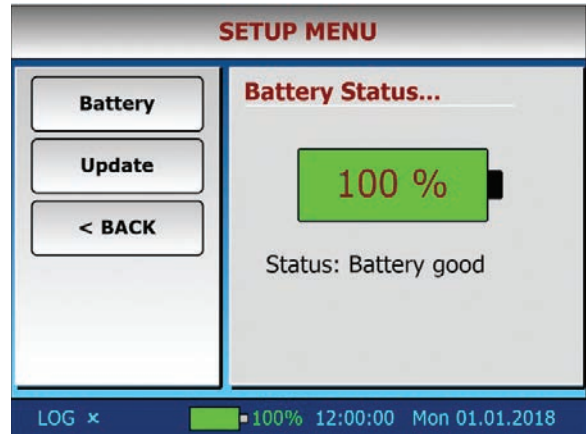

The Battery Screen provides information of the status of the MGATESTER1 battery (Ref: Battery Monitoring Section). The battery icon shows either the % remaining, or the of AC ~ symbol if the DC charger is connected. The battery icon is color-coded to depict the battery condition:

- Gradient green -charging
- Green - fully charged
- Orange - needs charging
- Red - flat

## MOV SCREEN



The MOV Screen is where the clamp voltage of the MOV under test (or SPD surge protector) is displayed. The measurement is performed by pressing the Measure Button on the front of the instrument. The constant current setting used is configured in the Measurement Screen.

*Note: If the LOG mode is turned ON, the measurement output is directed to the Log Screen rather.*



## GDTSCREEN

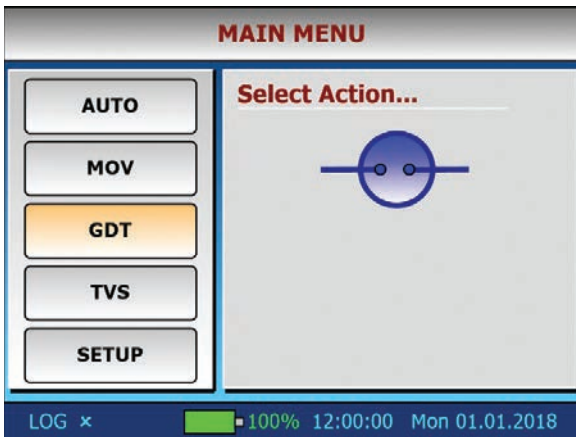

The GDT Screen is where the firing voltage of the GDT under test is displayed. The measurement is performed by pressing the Measure Button on the front of the instrument. The rate of voltage ramp in V/s used in this measurement is configured in the Measurement Screen.

*Note: If the LOG mode is turned ON, the measurement output is directed to the Log Screen rather.*

## TVSSCREEN

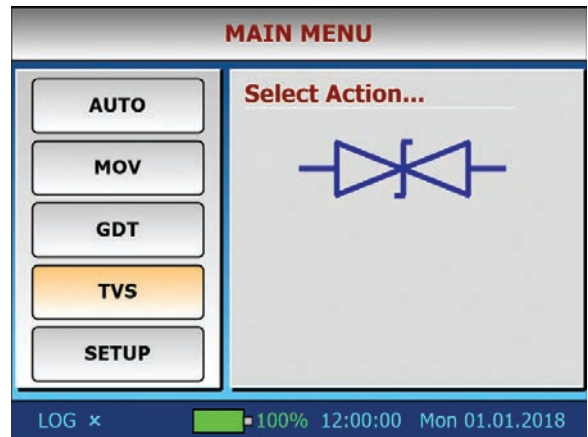

The TVS Screen is where the clamp voltage of the TVS device under test (or SPD surge protector) is displayed. The measurement is performed by pressing the Measure Button on the front of the instrument. The constant current setting used is configured in the Measurement Screen. The only difference between the TVS and MOV modes is that the possible voltage at the test leads is limited to 200V in the TVS mode, while in the MOV mode a maximum of 1500 VDC is possible to drive the required constant current.

*Note: If the LOG mode is turned ON, the measurement output is directed to the Log Screen rather.*

# Using MGATESTER1

## POWER ON

With MGATESTER1 in its OFF state, momentarily depress the ON/OFF button on the front panel to turn the instrument ON.

Enter the passcode (if Require Passcode option is enabled in the SETUP/Device- Setup/Set-Options menu) and click the Acknowledge...button in the Splash Screen signifying that the Warning message has been read (Ref. Safety section).

At the Main Screen the Welcome prompt will be displayed along with information such as the date and time when the instrument was last used, and a prompt to replace the clock battery if it is found to be low (Ref. Replacing Clock Battery section).

## POWER OFF

With MGATESTER1 in its ON state, momentarily depress the ON/OFF button on the front panel to put the instrument into its powering down sequence, during which it will perform an orderly shutdown and save various user configurations settings, and show the message "Shutting Down, please wait...".

*Note: In the event of an abnormal lock-up of the instrument or its firmware, the unit can be forced into a hard-ware power down by depressing the ON/OFF button and holding it depressed until the unit switches OFF after a few seconds.*

## RESTORING FACTORY DEFAULTS

When MGATESTER1 is started for the first time, it enters its User Commissioning Mode where factory defaults are loaded. It may also be forced to enter this mode if the user depresses the Measure button on the front panel at the same time the ON/OFF button is pressed to power up the instrument. During the User Commissioning phase, the following factory defaults are restored:

### Date/Time defaults:

- Time hh:mm:ss - 12:00:00
- Date wdy dd-mm-yyyy - Thu 01:01:2015

**Measurement defaults:**

- MOV constant current - 1mA
- GDT ramp rate - 1kV/s
- Prefire GDT - ON

**LCD defaults:**

- Backlight intensity - 100%
- Backlight - ON
- Backlight timeout - 60 secs

**User options defaults:**

- Default passcode - 1\_2\_3\_4
- Passcode required - YES
- System heartbeat - YES
- Button clicks -YES
- System inactivity timeout - 5 mins
- LOG mode - OFF x

# User Commissioning

Step1: Touch panel calibration: The user is requested to 'touch' using the stylus on the top right-hand corner of the frame, and then again on the bottom left-hand corner. If the touch is within expected limits, the coordinates are accepted and the display calibrated accordingly.

Step2: Instrument self-calibration: Please follow the instructions to first remove the test leads from the front terminal sockets and then press the Continue... button. The RED HV will briefly illuminate, indicating that high voltage is being produced at the terminals. Internal calibration is now complete.

Step3: Observe the Splash Screen warning - clicking the Acknowledge... button to signify that the Warning has been read and the potential hazard is understood.

Step4: Enter the default passcode 1\_2\_3\_4 to unlock the instrument.

The instrument enters the Main Screen and the blue LED extinguishes. The user can now proceed to customize the instrument in the Device Setup and Measurement Setup menus.

**DEVICE SETUP**

From the main menu navigate to: SETUP/Device-Setup

The Device Setup Menu, allows the user to select one of the following sub-menus:

- Set Time/Date
- Set Passcode
- Set Display
- Set Options

Click the < BACK button to return to the Main Menu

**MEASURE SETUP**

From the main menu navigate to: SETUP/Measure-Setup

The Measure Setup Menu, allows the user to select one of the following sub-menus:

- Set GDT Ramp Rate
- Set MOV Constant Current

Click the < BACK button to return to the Main Menu (Ref. Measurement Screen).

**SYSTEM STATUS**

From the main menu navigate to: SETUP/System-Status

The System Status Menu, allows the user to select one of the following sub-menus:

- Battery
- Update

Click the < BACK button to return to the Main Menu.

**ABOUT MGATESTER1**

From the main menu navigate to: SETUP/About-MGATESTER1

Displays information about the MGATESTER1 units including: Title, Model, Manufacturer, Copyright, Hardware and Firmware versions, the instruments serial number.

Click the < BACK button to return to the Main Menu.

**BATTERY MONITORING**

The battery voltage is continuously monitored by the tester and displayed by way of the battery icon on the display footer.

If the battery charger is plugged in (signified by AC ~), the battery is being maintained in a charged state. The charger automatically regulates as the battery condition determines, between a fast charge state (gradient green battery icon) and a trickle charge state (solid green battery icon).

If the instrument is running on battery power, the battery icon will indicate its percentage capacity in the range from 0-100 %. In addition, the icon will be colored to indicate the battery condition as:

- Green - fully charged (> 1.18V/cell).
- Orange - requires recharging (1.14 V < Bat < 1.18V).\*

- Red - completely flat (< 1.12 V/cell). The Blue battery LED on the front of the instrument will illuminate.

*\* Note: In this condition the instrument may yield inaccurate results when measuring MOV components which clamp above 900 VDC, or GDT components which fire above 1000 VDC.*



**Warning: To avoid false readings, recharge the batteries as soon as the battery icon appears as orange.**

## Measuring

### AUTO / MANUAL MEASUREMENT MODE

Measurements of surge protective components (SPCs) or surge protective devices (SPDs) can be performed in one of two ways with this instrument - using the Auto Mode or using the Manual Mode. The AUTO mode is selected by clicking the AUTO button on the Button Panel.

When in Auto mode the instrument attempts to carry out an auto-detection of the type of SPC or SPD connected, and configures itself to measure such device accordingly.

If a GDT component (voltage-switching device) is detected, it will configure itself into the voltage ramp mode. The measurement is performed by ramping the voltage across the component until it fires (also known as avalanche, breakdown, spark-over or crowbar). The peak voltage reached before breakdown is displayed on the Output panel. The rate of voltage ramp applied is setup in the Measure-Setup menu (Ref. Measurement Screen section).

The clamping voltage is displayed on the Output panel. The constant current applied is setup in the Measure-Setup menu (Ref. Measurement Screen section).

The Manual Mode allows the user to override auto-detection and specifically select the type of component or device being tested. This is done by clicking the MOV, GDT or TVS buttons on the Button Panel. The selection is indicated by shading the relevant button orange.

In general, the Auto Mode is more convenient where the SPD consists of a single protection component, or when multiple protection components of the same kind are used - for example, an SPD where the internal protection components are all MOVs. When a mix of technologies is used, such as in a so-called combination-type SPD where an MOV and GDT may be connected in series, it is generally better to use the Manual Mode, thereby having control over the instrument to enforce either a constant current, or a voltage ramp in performing the measurement.

In either Manual Mode or Auto Mode the instrument will display the unknown SPD Icon with either the word 'Open' or 'Short' if it encounters either an open-circuit or short-circuit path respectively. Under such condition, please check the lead set is correctly plugged into the instrument and connections to the device or component under test is secure.



**Warning: During measurement unit has to be disconnected from any power supply. Protective device must also be disconnected from power supply and must not be grounded.**



**Warning: During measurement of the protective device, USB port must not be used.**

If an MOV or TVS component (voltage - limiting device) is detected, it will configure itself into the constant current mode. The measurement is performed by driving a fixed constant current through the device and recording what voltage appears across the device (often referred to as the clamping voltage).

### MEASURING MOVs

To measure an MOV component (varistor), or an SPD comprising several metal oxide varistor internally:

Step1: Decide if using the Auto or Manual detection mode by pressing either the AUTO button or the MOV Button respectively.

Step2: Set the required constant current for the measurement (Ref. Measurement Screen section). The current used can be selected from one of 0.1 mA, 0.5 mA, 1.0mA.

*Note: It is normal to define the clamping voltage of an MOV as  $U_n$  @ 1 mA, so typically the 1.0 mA setting is the default option.*

Step3: If desired, enable the Log Measurement mode LOG Mode (Ref. Log Screen section). A check  $\checkmark$  in the Footer panel indicates this mode has been activated.

Step 4: Press the Measure button on the front panel of the instrument. The RED HV LED will briefly illuminate to indicate that high voltage is being produced at the output terminal sockets. Please ref to Safety section.

Step5: The reading will be displayed on the Output panel (Ref. MOV Screen section).

*Note: For more information on measurement of MOV components, the user is referred to: IEC 61643-331 Components for low-voltage surge protective devices - Part 331: Specification for metal oxide varistors (MOV).*

## MEASURING TVSs

Transient Voltage Suppressors (TVS), also called Avalanche Breakdown Diodes (ABDs), are tested in much the same way as an MOV. In the TVS Mode the maximum voltage used to drive the constant current is limited to 200 V since most TVS devices are below this voltage. To perform a measurement, please refer to the steps in the Measuring MOVs section.

The reading will be displayed on the Output panel (Ref. TVS Screen section).

*Note: For more information on measurement of TVS components, the user is referred to: IEC 61643-321 Components for low-voltage surge protective devices - Part 321: Specifications for avalanche breakdown diode (ABD)*

## MEASURING GDTs

To measure a GDT component (arrestor), or an SPD comprising voltage switching technology:

Step1: Decide if using the Auto or Manual detection mode by pressing either the AUTO button or the MOV Button respectively.

Step2: Set the required voltage rate ramp for the measurement (Ref. Measurement Screen section). The ramp rate can be selected from one of 100 V/s, or 1kV/s.

*Note: It is normal to define the DC spark-over voltage of a GDT as  $U_{dc}$  @ 1 kV/s, so the 1 kV/s setting is the default option.*

Step3: If required, enable the GDT Prefire mode which will force the GDT to be fired three times (pre-ionization) before the measurement is recorded.

*Note: The GDT Prefire option is disabled when the voltage ramp rate is set to 100 V/s as it would take too long to measure a GDT with high spark-over voltage. For example, if the GDT being tested has a spark-over voltage of 1500 V, and the ramp rate is set to 100 V/s, each reading would take 15s.*

Step4: If desired, enable the Log Measurement mode LOG Mode (Ref. Log Screen section). A check  $\checkmark$  in the Footer panel indicates this mode has been activated.

Step 5: Press the Measure button on the front panel of the instrument. The RED HV LED will briefly illuminate to indicate that high voltage is being produced at the output terminal sockets. Please ref to Safety section.

Step6: The reading will be displayed on the Output panel (Ref. GDT Screen section).

*Note: For more information on measurement of GDT components, the user is referred to: IEC 61643-311 Components for low-voltage surge protective devices - Part 311: Performance requirements and test circuits for gas discharge tubes (GDT).*

## MEASURING SPDs

Surge Protective Device (SPDs) in their simplest form comprise one or more non-linear surge protective components (SPC), a disconnecter (thermal or overcurrent) and some form of status indicator (mechanical or electronic).

The internal surge protective components are generally of two types - voltage switching (GDT, Thyristor etc) and voltage limiting (MOV, ABD, TVS etc). An SPD may also combine such components for example, a GDT and MOV in series.

An SPD may also have a number of modes of protection, such as Line-Neutral, Line- Line, Neutral-Ground etc.

Due to these many variations, no one method can be completely outlined for the testing of SPDs. In general, this requires some understanding and experience on the part of the operator. As a guide:

Step1: Ensure the status indication of the SPD will not interfere with measurements. If the SPD is a typical DIN rail type, as used in many IEC based markets, the status indication will be a mechanical flag, rather than electronic circuit, so isolation of this circuit is not required.

Step2: Using the manual mode select either GDT or MOV mode based on the components inside the SPD.

*Note: If the SPD is a combination type comprising MOV+GDT it is recommended to manually set the instrument to its MOV mode by pressing the MOV Button. In this mode the instrument will raise the voltage across the combination type SPD until the switching component fires and a constant current flows through the combination.*

*The measurement obtained will be a function of the MOV clamp voltage @ 1.0 mA and the break down voltage of the GDT. Note: Set the required constant current for the measurement (Ref. Measurement Screen section) to 1.0 mA.*

Step3: If desired, enable the Log Measurement mode LOG Mode (Ref. Log Screen section). A check  $\checkmark$  in the Footer panel indicates this mode has been activated.

Step 4: Press the Measure button on the front panel of the instrument. The RED HV LED will briefly illuminate to

indicate that high voltage is being produced at the output terminal sockets. Please ref to Safety section.

Step5: The reading will be displayed on the Output panel (Ref. MOV Screen section).

*Note: For more information on measurement of SPD devices, the user is referred to: IEC 61643-11 Low-voltage surge protective devices - Part 11: Requirements and test methods.*

## UPDATING THE FIRMWARE

The firmware developed for the MGATESTER1 has been extensively tested and found to be stable and reliable in use, however as with all software, unanticipated behavior may occur requiring correction, or improvements with additional features and functionality may be released from time-to-time. The firmware in the MGATESTER1 incorporates its own 'bootloader' program which allows it to install updated firmware revisions as and when the factory makes this available.

A small utility program needs to be installed on the PC which will be used to download the new firmware file (updatexxx.hex) to the instrument. This is a third party software developed by MikroElektronika(1) for this purpose (Ref. Figure 5).



Figure 5: Bootloader PC application software used to upload MGATESTER1 firmware updates.



**Warning: Updating the firmware in the instrument is a complicated process and should only be undertaken if absolutely necessary and where the user feels he has sufficient capability. In- correctly following the steps provided, or prematurely terminating the update once started, may leave MGATESTER1 in a locked-up state, and require return to the factory. If the user is unable to perform this update, please contact our technical support department for assistance.**

1 USB HID Bootloader Tool is registered to MikroElektronika D.O.O., Belgrade.

Key: BL-Mode > Bootloader mode  
PR-Mode > Program mode

### To upgrade the firmware please follows these steps:

1. Turn the instrument ON.
2. From the Main Screen click to reach the SETUP/System-Status sub-menu.
3. Click Update in the Buttons panel.
4. Follow user prompts - an < Exit button is provided at the last prompt should the user wish to exitback to the Main menu at this stage.
5. If Continue... is pressed the instrument will reboot and the RED LED light to show it has entered the BL-Mode
  - RED LED > MGATESTER1 is in BL-Mode
  - GREEN LED blinking > MGATESTER1 is waiting for PC application to connect
6. Connect MGATESTER1 to the PC using a standard USB printer cable
7. Start the USB HID Bootloader PC application and click the Connect button
  - GREEN LED solid > PC application is now connected with MGATESTER1
  - Bootloader firmware in MGATESTER1 is now waiting for upload of the new firmware file
8. On the USB HID Bootloader PC application click browse and select the update firmware file "ProSCTxxx.hex"
9. Click the Begin Upload button
  - The progress bar shows the new firmware being loading to MGATESTER1
10. Once the upload is complete, MGATESTER1 will reboot into its User Configuration Mode
  - BLUE LED > MGATESTER1 is in PR-Mode
11. Disconnect the USB cable.
12. Update is complete and the About Screen should show the new version of firmware installed.

# Maintenance

## CLEANING

Periodically wipe the case and display with a damp cloth and mild detergent. Do not use abrasives or solvents. Dirt or moisture in the terminals can affect readings and should be removed when evident.

### To clean the terminals:

1. Ensure that the instrument is in the shutdown state.
2. Remove the battery cover and remove one of the batteries, remove the charge unit cord from the DC socket.
3. Remove the test leads.
4. Shake out any dirt that may be in the terminals.
5. Soak a cotton swab with white spirits alcohol and clean inside and around each terminal socket on the instrument.
6. Likewise, clean the test lead plugs and alligator clips with white spirits alcohol.

## REPLACING MAIN BATTERY

It is recommended that AA NiMH cells with at least 2300 mAh (Ref. General Specifications section of this manual) be used in this instrument. Typically, such batteries can withstand 500 recharge cycles.



**Do not use non-rechargeable batteries. Use only rechargeable battery NiMH, 1,2V, AA.**



**Warning: To avoid electrical shock or personal injury, remove the DC charger plug and the test lead set before replacing the battery. Be sure that the battery polarity is correct. A reversed battery may damage the instrument.**

### To replace the batteries (refer to Figure 6):

1. Turn OFF the instrument.
2. Remove the test lead set from the front terminals.
3. Remove the battery cover locking screw if present using a small Philips screwdriver.
4. Press the release latch and remove the battery cover.
5. Replace the batteries by observing the marked polarities and replace the battery cover.
6. Secure the cover by replacing the locking Philips screw.

## REPLACING CLOCK BATTERY

The real time clock (RTC) which maintains the time and date on the Main Screen footer is backed up with an internal CR2025 3V

Lithium coin cell battery. In order to replace this battery, the back cover of the MGATESTER1 unit must be removed.



**Warning: To avoid electrical shock or personal injury, remove the DC charger plug and the test lead set before replacing the internal clock battery. Be sure that the battery polarity is correct. A reversed battery may damage the instrument.**

### To replace the RTC battery (Ref. Figure 6):

1. Turn OFF the instrument.
2. Remove the test lead set from the front terminals.
3. Remove the main battery cover locking screw if present using a small Philips screwdriver.
4. Press the release latch and remove the battery cover.
5. Remove an AA cell of the main battery.
6. Remove the six screws securing the back half of MGATESTER1 enclosure to the front half. Carefully separate the two halves avoiding placing any strain on the interconnecting wiring between the two halves.
7. The CR2025 coin battery is clearly evident on the main PCB in a small battery holder.
8. Taking careful note of the battery polarity, remove the depleted coin battery and replace with a fresh one.
9. Reposition the two halves of the enclosure and replace the six screws avoiding over tightening.
10. Insert the main AA batteries by observing the marked polarities and replace the battery cover.
11. Secure the cover by replacing the locking Philips screw.
12. Restart the instrument in its User Commissioning Mode by depressing the Measure button on the front panel at the same time the ON/OFF button is pressed (Ref. Restoring Factory Defaults section).
13. Adjust the time and date (Ref. Time/Date Screen section).

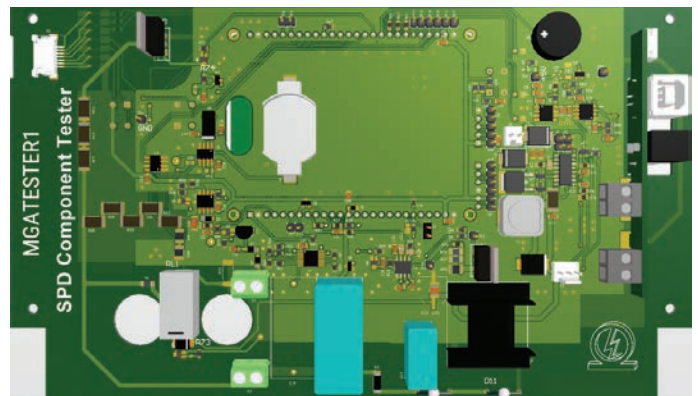

Figure 6: Location of CR2025 real time clock battery

# Specifications

## FEATURES

- Self-calibration
- Illuminated color TFT display and touch screen interface
- User configurable menu and options
- Auto-detection of type of SPD component connected
- Measurement programs for MOVs, GDTs and ABDs
- Test GDTs and MOVs up to 1500VDC
- Display of successive measurements using LOG Mode
- Internal intelligent battery charger
- Remote firmware update capability

## INCLUDED ACCESSORIES

- Test lead set with alligator clips
- 5 x AA Batteries, NiMH, 1.2V, 2450mAh
- 12 VDC multi-system power adapter, 100 VAC - 240 VAC, 2000mA
- LCD touch screen stylus

## GENERAL SPECIFICATIONS

Specification	Characteristics
Size	220 mm (W) x 205 mm (H) x 82 mm (D)
Weight (with batteries)	0.94 kg
Battery size, quantity	Type AA, 5 ea.
Battery type	NiMH (supplied)
Battery life (typical)	200 hours idling
Operating Temperature	-10 °C to 50 °C
Storage Temperature	-10 °C to 60 °C indefinitely (to -40 °C for 100 hrs)
Relative Humidity	80 % 10 to 35 °C; 70 % 35 to 40 °C
Operating Altitude	0 to 2000 meters
Vibration	Class 3 per Mil-Prf-28800F
Enclosure Sealing	IP 20
Enclosure Material	ABS (UL 94 HB)
Pollution Degree	2

## MEASUREMENT ACCURACY

Specification	Characteristics
MOV / ABD Constant Currents Options	0.1 mA, 0.5 mA, 1.0 mA
GDT Voltage Ramp Rate Options	100 V/s, 1000 V/s
Max. Test Voltage	1500 VDC
MOV Measurement Accuracy*	1.5 % +/- 2 digit counts
GDT Measurement Accuracy*	1kV/s: 3.5 % +/- 2 digit counts 100V/s: 1.6 % +/- 2 digit counts

\* The accuracy specification is defined as  $\pm$  (% reading + digit counts) at 25 °C  $\pm$  5 °C, < 80 % RH.

## PHYSICAL DIMENSIONS

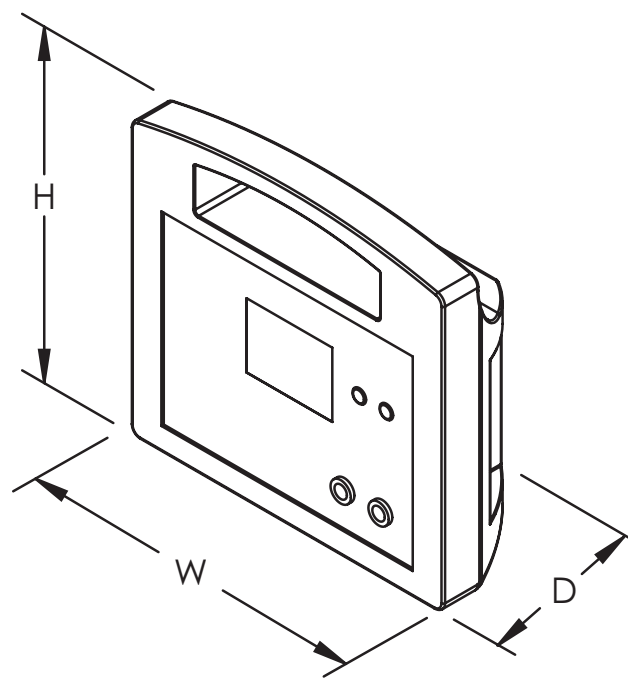



Our powerful portfolio of brands:

**CADDY ERICO HOFFMAN RAYCHEM SCHROFF TRACER**

**WARNING:** nVent products shall be installed and used only as indicated in nVent's product instruction sheets and training materials. Instruction sheets are available at [nVent.com/ERICO](http://nVent.com/ERICO) and from your nVent customer service representative. Improper installation, misuse, misapplication or other failure to completely follow nVent's instructions and warnings may cause product malfunction, property damage, serious bodily injury and/or death, and void your warranty.

©2018 nVent. All nVent marks and logos are owned or licensed by nVent Services GmbH or its affiliates. All other trademarks are the property of their respective owners. nVent reserves the right to change specifications without notice.

ERICO-IM-H84603-MGATESTER1-EN-1812