

ERICO® INTERCEPTOR SI25i, SI40i or SI60i

Installation Instructions for 5m Stainless Steel Cantilevered Mast - SIM Series

Terminal Elevation: 4m Above Structure

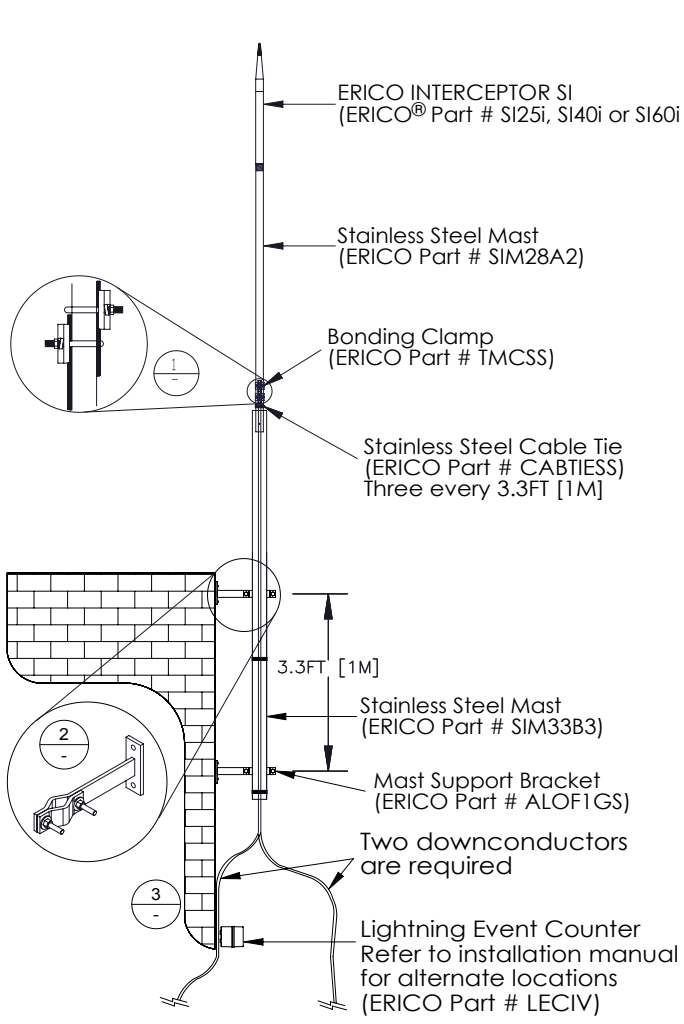

For complete grounding system refer to Detail "A"

Minimum 2/0 (50 mm²) Conductor (3 x 20 FT [6.1M] length) Enclosed in GEM material

Mast Detail

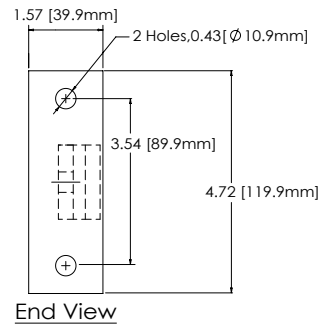
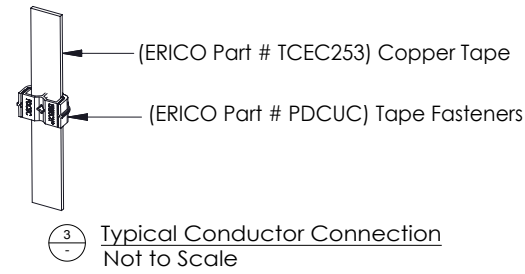
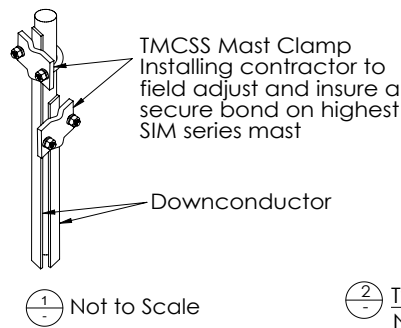
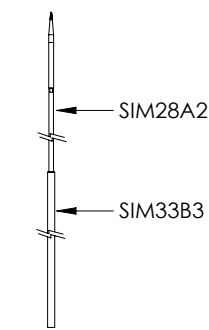

Detail "A"

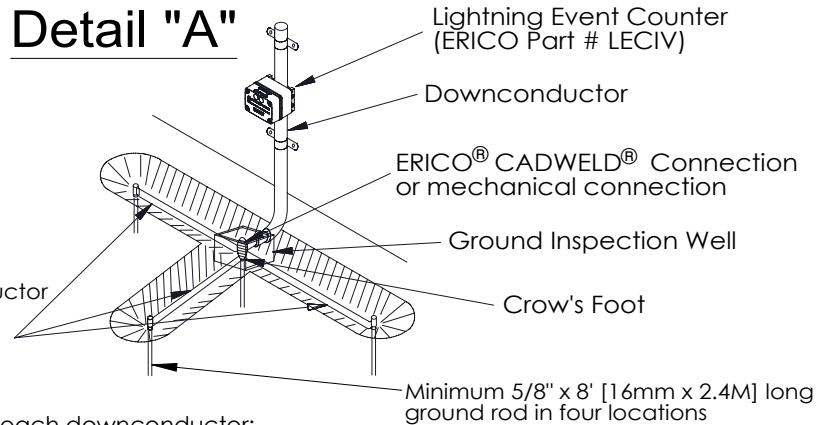

Suggested three radial grounding system for each downconductor:

The grounding system shown in the detail is a suggested layout. Each radial consists of a trench approximately 1.5FT [.45M] deep. The conductor is laid in the trench and is connected to ground rods. The conductor in each trench is encased in GEM material. Ground rods must extend 10FT [3M] below ground level.

Note: This is one of several alternative installation methods. Refer to ERICO instruction print IP79157 for more details. ERICO is not responsible for field installation of lightning protection systems. The installation integrity of each system should be approved and stamped by a structural professional engineer.

WARNING:

1. ERICO products shall be installed and used only as indicated in ERICO product instruction sheets and training materials. Instruction sheets are available at www.erico.com and from your ERICO customer service representative.
2. ERICO products must never be used for a purpose other than the purpose for which they were designed or in a manner that exceeds specified load ratings.
3. All instructions must be completely followed to ensure proper and safe installation and performance.
4. Improper installation, misuse, misapplication or other failure to completely follow ERICO's instructions and warnings may cause product malfunction, property damage, serious bodily injury and death.

SAFETY INSTRUCTIONS:

All governing codes and regulations and those required by the job site must be observed. Always use appropriate safety equipment such as eye protection, hard hat, and gloves as appropriate to the application.

CADDY, CADWELD, CRITEC, ERICO, ERIFLEX, ERITECH, and LENTON are registered trademarks of ERICO International Corporation.

