

nVent ERICO Cadweld Multi



IP7951_E

Copper Cable / Solid	GE	GF	GG	GJ	GW	PA	PG
<p>*2.5 - 50 mm² (Ø 1.8 - 9.3 mm) **12 Solid to 1/0 Stranded</p>							
	PK	PP	SC	SS	TA	XA	XB

Copper Cable / Solid	TD	TE	TF
<p>*2.5 - 25 mm² (Ø 1.8 - 6.5 mm) **12 Solid to 2 Solid</p>			

Copper or Steel Cable / Solid	Rebar / Copper or Galvanized Steel Tape	RD	RF	RG	RH	RK
<p>* 2.5 - 50 mm² (Ø1.8 - 9.3 mm) **12 Solid to 1/0 Stranded</p>	<p>* Ø 6 - 10 mm **#3 * 30 x (0.5 - 3.5 mm) **1.2 in x (0.02 in - 0.14 in)</p>					

Copper Cable / Solid	Copper or Galvanized Steel Tape	HA	HC	HS	HT	GL
<p>* 2.5 - 50 mm² (Ø1.8 - 9.3 mm) **12 Solid to 1/0 Stranded</p>	<p>*30 x (0.5 - 3.5 mm) **1.2 in x (0.02 in - 0.14 in)</p>					
		LA	LE			









Copper Tape	BB and CG	BG	CG	EB
<p>*30 x (0.5 - 3.5 mm) **1.2 in x (0.02 in - 0.14 in)</p>	<p>3 mm</p>			
<p>BG and EB *30 x (0.5 - 3.0 mm) **1.2 in x (0.02 in - 0.12 in)</p>				



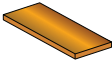





Galvanized Steel Tape	BB	CG
<p>* 30 x (0.5 - 3.5 mm) ** 1.2 in x (0.02 in - 0.14 in)</p>	<p>3 mm</p>	

All horizontal connections require:

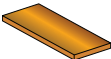
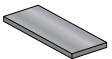
#90 or 90PLUSF20

* Metric
** Imperial

Copper Cable / Solid	Ground Rod / Copper Tape	Copper or Steel Tape			
 <p>*Up to 10 mm² (Ø 4.1 mm) Stranded</p>	 <p>* 12.7 mm, 14.2 mm, 17.2 mm ** 1/2 in, 5/8 in, 3/4 in</p>	 <p>* 30 mm x (0.5 - 2.0 mm) ** 1.2 in x (0.02 in - 0.08 in)</p>			
 <p>** #6 (Ø 0.18 in) Stranded</p>					

Copper Cable / Solid	Ground Rod	Copper Tape	Steel Tape			
 <p>* 10 mm² Stranded - 50 mm² Stranded ** #6 Stranded - 1/0 Stranded Note: No larger than 35 mm² (#2) Solid for TG connections</p>	 <p>*12.7 mm, 14.2 mm, 17.2 mm **1/2 in, 5/8 in, 3/4 in</p>	 <p>* 30 x (0.5 - 3.0 mm) ** 1.2 in x (0.02 in - 0.12 in) Note: .063 in (2 mm) max thickness for CP connections</p>	 <p>* 30 x (0.5 - 3.5 mm) ** 1.2 in x (0.02 in - 0.14 in) Note: Not for use with CP connections</p>			
						

All conductor to ground rod vertical connections require:

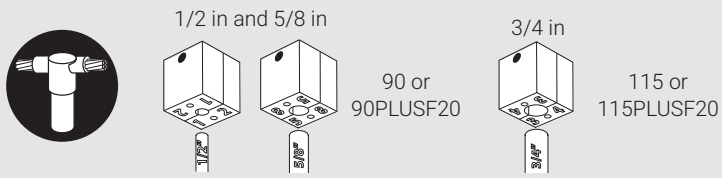

Note:
For connections using galvanized material, remove galvanizing before welding.

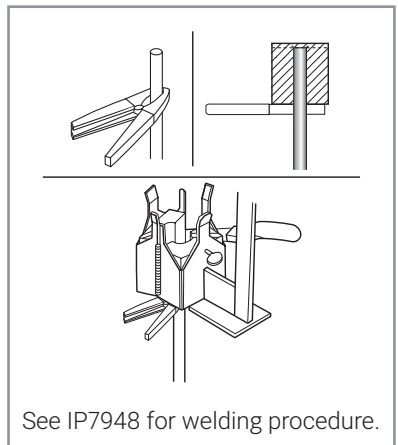

* Metric
** Imperial



Our powerful portfolio of brands:

CADDY ERICO HOFFMAN RAYCHEM SCHROFF TRACER