

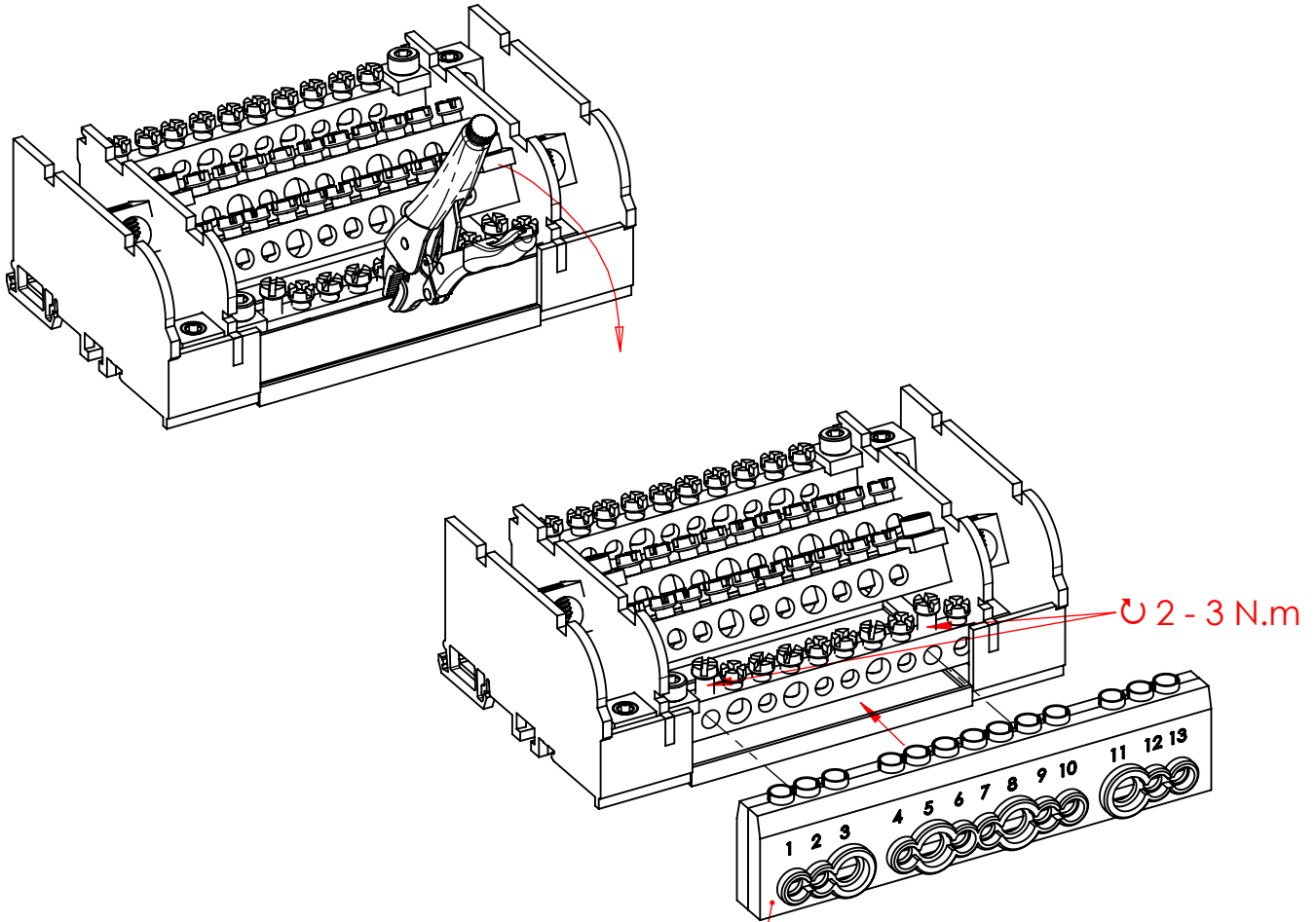







Neutral Bar for TD Distribution Blocks NB-125A (563841)



NB-125A used for distribution blocks 563830 and 563840

-  Metric rigid stranded cable
-  Metric flexible stranded cable

			563841	Hole Ø		
⇐	10 - 25mm ²	6 - 16mm ²	x3	7,5mm		2 - 3 N.m
⇐	2,5 - 6mm ²	1,5 - 6mm ²	x9	5,5mm		2 - 3 N.m

Note :

1. Tighten screws of unused galleries to torque of 0,5 - 1 N.m

WARNING:

1. nVent products shall be installed and used only as indicated in nVent product instruction sheets and training materials. Instruction sheets are available at www.nVent.com and from your nVent customer service representative.
2. nVent products must never be used for a purpose other than the purpose for which they were designed or in a manner that exceeds specified load ratings.
3. All instructions must be completely followed to ensure proper and safe installation and performance.
4. Improper installation, misuse, misapplication or other failure to completely follow nVent's instructions and warnings may cause product malfunction, property damage, serious bodily injury and/or death, and void your warranty.

SAFETY INSTRUCTIONS:

All governing codes and regulations and those required by the job site must be observed. Always use appropriate safety equipment such as eye protection, hard hat, and gloves as appropriate to the application.

nVent, nVent CADDY, nVent ERICO Cadweld, nVent ERICO Critec, nVent ERICO, nVent ERIFLEX, and nVent LENTON are owned by nVent or its global affiliates. All other trademarks are the property of their respective owners. nVent reserves the right to change specifications without prior notice.

TECHNICAL SUPPORT
www.nVent.com

IP8450_A

1 OF 1

© 2018-2019 nVent All Rights Reserved