



# CADWELD® Rail Grounding Connections – Web Bonds

## I. HOW TO READ THESE INSTRUCTIONS/WHAT THE SYMBOLS MEAN









The purpose of safety symbols is to attract your attention to possible dangers. The safety symbols, and the explanations with them, deserve your careful attention and understanding. The safety warnings do not by themselves eliminate any danger. The instructions and warnings are not substitutes for proper accident prevention measures.

-  **SAFETY ALERT SYMBOL:** Indicates warning or caution. It may be used in conjunction with other symbols or pictographs.
  -  **WARNING:** Failure to obey a safety warning may result in property damage, serious personal injury or death, and the serious personal injury or death of others. Always follow the safety precautions to reduce these risks.
  -  **CAUTION:** Failure to obey a safety caution may result in property damage, personal injury, and injury to others. Always follow the safety precautions to reduce the risk of fire, other property damage and personal injury.
- NOTE:** Advises you of information or instructions vital to the operation or maintenance of the equipment.

In the following instructions, cautions and warnings, there are two types of consequences for failure to heed:

- A. IMMEDIATE,** that may result in personal injury or a failed operation that may result in a less than optimum bond and that will not give the physical and electrical performance expected.
- B. EVENTUAL,** that may result in a later premature rail break, causing a serious derailment accident with personal injuries or death, and loss of property.

## II. GENERAL RULES FOR SAFETY IN THE APPLICATION OF EXOTHERMIC JOINT HEAD BONDS AND WEB BONDS TO RAIL

-  **WARNING:** Do not attempt to make an exothermic bond until you have thoroughly read and understand the instructions that accompany all of the various components of the system and have been properly trained in the use of this product. Use only the system components designed to be used together from a single manufacturer. Failure to comply may result in unsatisfactory bonding as well as accidents involving fire, personal injury, and rail damage that may lead to property damage, injury or death.
-  **WARNING:** Only the correct grinding equipment, welding equipment, welding material, and bonds designed for the specific application must be used. All items used must be designed and supplied by the same manufacturer. All items must be in good condition and not worn, altered or damaged. Failure to do so may result in an unsafe application with the risk of personal injury and/or a less than optimum bond.
-  **WARNING:** The area where the bond is to be applied must be sheltered sufficiently if the weather is inclement. This is to keep the rail surface, all equipment, and materials dry until the weld is completed. Failure to do so may result in an unsafe application with the risk of personal injury and a less than optimum bond. 
-  **CAUTION:** The work area must be well ventilated. Workers should avoid breathing the smoke of the exothermic reaction by positioning themselves upwind of the mold before igniting the welding material. After ignition, it is advisable to step back from the mold. Failure to observe this instruction may result in lung irritation. 
-  **WARNING:** The worker(s) performing the welding must be properly dressed and equipped. Examples include cotton or woolen garments (most synthetic fabrics melt rather than char when exposed to flame, causing severe burns), safety footwear with non-slip soles, head protection, leather gloves, eye goggles and other clothing and equipment recommended or required by the person's employer, industry practice, or applicable laws and regulations. **See Figure 1.** The worker(s) must not be under the influence of any alcohol, drugs or other chemicals that would impair their judgment or performance of the job. Failure to observe this may result in serious personal injury. 

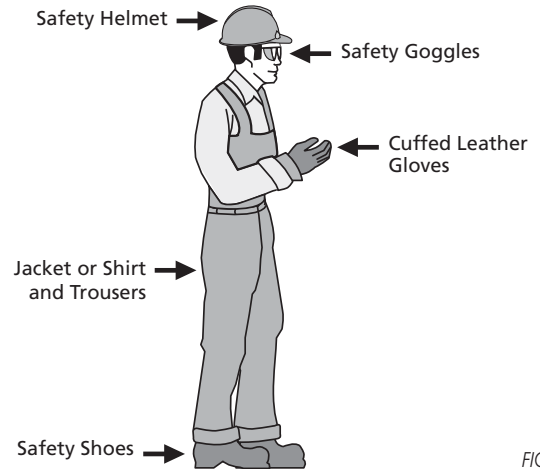









FIGURE 1

-  **CAUTION:** The worker(s) must be certain that they can achieve good footing in the area where the weld will be done. They should be able to step away from the weld reaction, to be upwind of it. Failure to observe this may result in personal injury. 
-  **WARNING:** Carefully following the instructions for exothermic bonding is very important to achieving a quality reliable bond. Failure to do so may cause hidden potential problems, the least of which is a poor electrical connection, and the most serious of which is an eventual broken rail leading to property damage, injury or death to the installer and others. 

## III. PREPARATION

-  **WARNING:** Protect against potential fire hazards local to the bonding area and remove all flammable materials from the work area. Notify in advance other workers in the immediate area that a welding procedure is about to be done. Failure to do this increases the risk of fire with the possibility of property damage, personal injury and death. 

**NOTE:** In case of a fire involving large quantities of exothermic welding material, CO<sub>2</sub> or large quantities of water applied from a distance are required to reduce the spread of the fire.

-  **WARNING:** The location of the bond is very important! Rail track connection web bonds must be made at the neutral axis of the rail. Failure to observe this may result in a rail break leading to property damage, injury or death to others. **TRACK CONNECTION BONDING MUST NEVER BE DONE ON OR NEAR THE HEAD OR BASE OF THE RAIL.** See Figure 2.

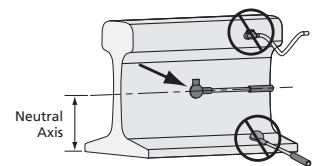

FIGURE 2

- Clean the rail surface and bond terminals. Scrape off excess dirt and grease, and wipe away any remaining residue using a clean rag saturated with a railroad approved solvent. **See Figure 3.** The cable and rail surface must be dry prior to welding!

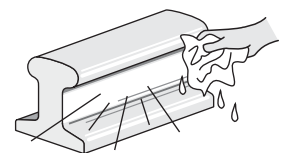

FIGURE 3

# CADWELD® Rail Grounding Connections – Web Bonds

**WARNING:** The area of the rail where the web bond will be applied and the bond terminals must be clean and dry. Failure to comply can cause poor bonding, excessive weld porosity, and/or spewing molten welding material with the potential for serious burns to the worker.

- Use abrasive cloth or wire brush on the bond terminals if needed to remove surface oxidation.

**CAUTION:** The bond terminals must have a bright surface. Failure to comply with this may result in a less than optimal weld. See Figure 4.

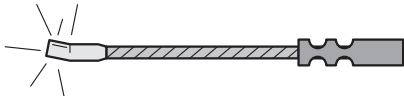

FIGURE 4

- Lightly grind the rail surface using an ERICO approved grinding wheel that is self-cleaning or a CADWELD® brand Rail Head and Web Cleaner (Part SBB394C). Grinding wheels with resin binders tend to leave a surface film that may contaminate the surface, interfering with the achievement of an optimum bond and causing weld porosity.

**WARNING:** The area of the rail web to be bonded must be lightly ground to a bright finish with no visible scratch marks or gouges (normal uniform finishing marks are acceptable). Failure to observe this may result in visible scratches or gouges due to overly aggressive grinding that are potential crack initiators and that may lead to rail breaks causing derailment accidents with property damage, injury and death to others. See Figure 5.

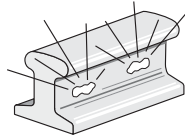

FIGURE 5

**CAUTION:** Grinding must not be done more than 4 hours prior to bonding. If the time lapse is longer, sufficient contaminating rust may re-form requiring additional grinding. Failure to observe this may result in a less than optimum bond.

- Dry the mold and rail by heating them to about 250°F (120°C) with a small propane torch.

**WARNING:** The rail and mold must both be warmed to drive off moisture. Failure to observe this may result in weld spatter with the potential for serious burn injury, and a less than optimum bond with excessive porosity. See Figure 6.

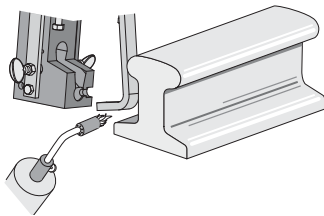

FIGURE 6

**WARNING:**

- Connections should not be made to load bearing rail steel other than at the neutral axis of the rail or at the head of the rail within the confines of the joint/splice bar.
- All connections to rail steel should only be made where the rails are fully supported, or to rail that is non-load bearing in its use.
- The welding material size for the connection to rail steel should not be greater than 250 grams (which, in general, corresponds to a maximum cable size of 500 kcmil (240 mm<sup>2</sup>).

**WARNING:** Rebonding over the application of an earlier web bond is strictly forbidden! Rebonds must be applied at least two inches away (centerline to centerline) from an earlier bond to avoid serious structural harm to the rail. Failure to observe this may result in a rail break leading to property damage, injury or death to others.

**WARNING:** Back-to-back bonding of web bonds is strictly forbidden! Bonds made on the opposite side of the rail to an earlier web bond must be applied at least two inches away (centerline to centerline) from the earlier bond to avoid serious structural harm to the rail. Failure to observe this may result in a rail break leading to property damage, injury or death to others.

**CAUTION:** Install only the specified welding material in the mold crucible. Use only the welding material size that is specified on the mold. ERICO brand of welding material (F80) is formulated specifically for use with rail steels; it is packaged in a blue tube with a yellow cap. Dump all of the welding material into the crucible, then carefully tap the tube on a hard surface to loosen the starting material from the bottom of the tube and distribute half on top of the welding material, close the mold cover, and pour the remainder in the opening of the mold cover. See Figure 7. Failure to comply may result in difficulty getting the reaction started and/or an unacceptable weld.

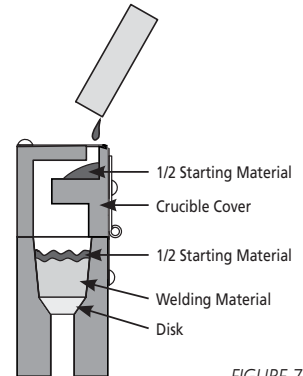

FIGURE 7

**CAUTION:** Avoid direct eye contact with the “flash” of light from the ignition of the starting material.

- Position yourself upwind of the mold, on the field side of the rail. Place the tip of the flint igniter at the cover opening and ignite. Remove the igniter quickly to prevent fouling.

**CAUTION:** Allow 15 seconds for mold cooling after the reaction. This will permit the molten metal to solidify. Then carefully disengage the welder device and pull the mold straight back from the rail. Failure to observe this may result in mold damage and its premature scrapping. Molds can generally be re-used up to 50 times.

- Carefully open the mold cover and break up the slag in the crucible using the blade of the mold cleaning tool. Dump the slag from the crucible and remove slag from the taphole using the curved end of the mold cleaner. Dump slag in the ballast, not onto the ties.
- Check the molds for breakage or residual slag before proceeding with the next weld.

**Note:** If you have any questions or require further instructions, or would like training, contact ERICO at 1-800-447-7245.