

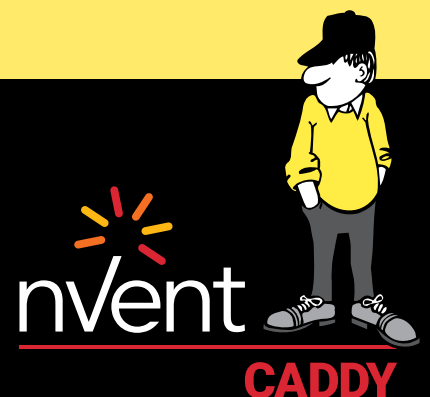

**CONNECT AND PROTECT**

# Mechanical, Electrical and Plumbing Seismic Bracing Systems



# Single Pipe Attachments

xxxx designated in the part numbers refers to products with multiple sizes and/or finishes available.

## STEEL PIPE



Quick Grip Jr.  
Lateral Sway Brace  
CSBQIKCLxxxxEG – p. 24



Quick Grip  
Lateral Sway Brace  
CSBQGxxxxEG – p. 26



Standard Universal  
Sway Brace  
CSBTUxxxxEG  
– p. 22



Universal Sway Brace  
CSBxxxx – p. 21



## REPLACEMENT HARDWARE

Cone Point Shear Bolt  
– p. 30

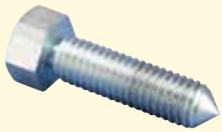

Shear Nut  
– p. 30



Rivet Head Shear Bolt  
– p. 30



Self Drilling Screw  
– p. 30

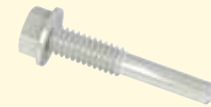

Branch Line Restraint  
Pipe Attachment  
CSBBRPxxEG  
– p. 37



Lateral Telescoping  
Brace Assembly  
CSBTx – p. 31



# Single Pipe Attachments

xxxx designated in the part numbers refers to products with multiple sizes and/or finishes available.

## STEEL PIPE



**Wire Spool**  
CSBxxCBLxx – p. 32



**Oval Sleeves**  
CSBxxSLVBxx – p. 33



## WIRE ROPE CUTTERS

SLWC – p. 32



CSBC48 – p.32



## SWAGING TOOLS

**Battery-Operated Swaging Tool**  
– p. 35



**Manual Swaging Tool**  
– p. 35



**Multi-Size Manual Swaging Tool**  
– p. 35



## STAINLESS STEEL PIPE



**Wire Spool, Stainless Steel**  
CSBxxCBLSS – p. 32



**Oval Sleeves**  
CSBxxSLVBSS – p. 33



## CPVC PIPE



**Lateral Telescoping Brace Assembly**  
CSBTx – p. 31



**Universal Restraint Clip**  
CSBURCxxxx – p. 33  
CSBURCRxx – p. 34



**Wire Spool**  
CSBxxCBLxx – p. 32



**Oval Sleeves**  
CSBxxSLVBxx – p. 33



# Trapeze and Equipment Attachments

xxxx designated in the part numbers refers to products with multiple sizes and/or finishes available.

## STRUT BRACE



Trapeze Sway Brace, Strut  
CSBR2 – p. 28



## PIPE BRACE



Trapeze Sway Brace, Pipe  
CSBR1 – p. 29



## CABLE



Wire Spool  
CSBxxCBLxx – p. 32



Oval Sleeves  
CSBxxSLVBxx – p. 33



Universal Restraint Clip  
CSBURCxxxx – p. 33  
CSBURCRxx – p. 34



# Rod Stiffeners

## STRUT BRACE



nVent CADDY Quick Clip  
CSBRSx – p. 36



Strut Rod Stiffener  
CSBRS37EG – p. 36



## PIPE BRACE



Pipe Rod Stiffener  
CSBRS1 – p. 36





# Structural Attachments

xxxx designated in the part numbers refers to products with multiple sizes and/or finishes available.

## STEEL



**I-Beam Attachment**  
CSBBC075EG  
– p. 16



**Bar Joist Attachment**  
CSBBARJEG – p. 14



**Adjustable I-Beam Attachment**  
CSBIBxxxxxEG  
– p. 15



**Universal Structural Attachment**  
CSBUNIVxxxEG – p. 18



**Universal Structural Bracket, Strut Brace**  
CSBUSx – p. 19



**Strut Seismic Hinge Bracket Assembly**  
CSBUSxPA – p. 19



**Universal Restraint Clip**  
CSBURCxxxx – p. 33  
CSBURCRxx – p. 34



**No Pry Clip**  
CSBNPCxx – p. 34

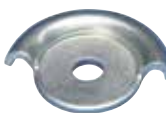

**Branch Line Restraint Structure Attachment to Steel**  
CSBBRS1MEG – p. 37



**Branch Line Restraint Structure Attachment to Threaded Hole**  
CSBBRS3MEG – p. 38



# Structural Attachments

xxxx designated in the part numbers refers to products with multiple sizes and/or finishes available.

## WOOD, CONCRETE



Universal Structural Bracket, Strut Brace  
CSBUSx – p. 19



Strut Seismic Hinge Bracket Assembly  
CSBUSxPA – p. 20



Universal Structural Attachment  
CSBUNIVxxxEG – p. 18



Load Doubler  
CSBMAxxxxxxEG – p. 17



No Pry Clip  
CSBNPCxx – p. 34



Branch Line Restraint Structure Attachment to Threaded Hole  
CSBBRS3MEG – p. 38



Branch Line Restraint Structure Attachment to Wood/Concrete  
CSBBRS2MEG – p. 38



## Related Products

### HIGH LOAD CONCRETE ANCHORS AND SCREWS



BSZ-SU Concrete Screw  
BSZSUxxxxZL – p. 39



Bolt Expansion Anchor  
SABxxxxxx – p. 40



# Related Products

xxxx designated in the part numbers refers to products with multiple sizes and/or finishes available.

## PIPE CLAMPS

2-Bolt Pipe Clamps  
- p. 39



nVent CADDY Macrofix Insulated M8/M10  
- p. 39



nVent CADDY Macrofix Plus Insulated  
- p. 39



nVent CADDY Macrofix Insulated Ventilation Duct Clamp  
- p. 39



## STRUT CLAMPS

USC Universal Strut Clamp for Pipe/Conduit  
- p. 40



C-EC Cable to Strut Clamp  
- p. 40



nVent CADDY Cushion Clamp Insulated Strut Clamp for Pipe/Tube  
- p. 40



## MISCELLANEOUS



RS Retrofit Retainer Strap  
RSxx - p. 41



Telescoping Support Brackets  
TSR1220x - p. 41



SN Series Nut  
SNxx - p. 42



SNSW Flanged Nut  
SNSWxx - p. 42



Seismic Lighting Fixture Clamp  
- p. 41



# nVent CADDY Seismic Bracing Systems Overview

nVent CADDY Seismic Solutions protect people, property and equipment during and after a seismic event by ensuring business continuity and continued operation of critical infrastructure and services. Areas of nVent CADDY expertise:

- Designing a complete, right-sized bracing system
- Identifying the appropriate product from our broad offering
- Offering compatible attachment and support products
- Explaining installation techniques and tips to meet evolving codes and standards requirements

From design to construction to inspection, the nVent CADDY team makes seismic simple by walking you through the full process for applications including Mechanical, HVAC, Electrical, Plumbing and Fire Protection.

Both cable and rigid bracing solutions are available for single pipe, trapeze, and for floor-, roof-, and wall-mounted equipment.

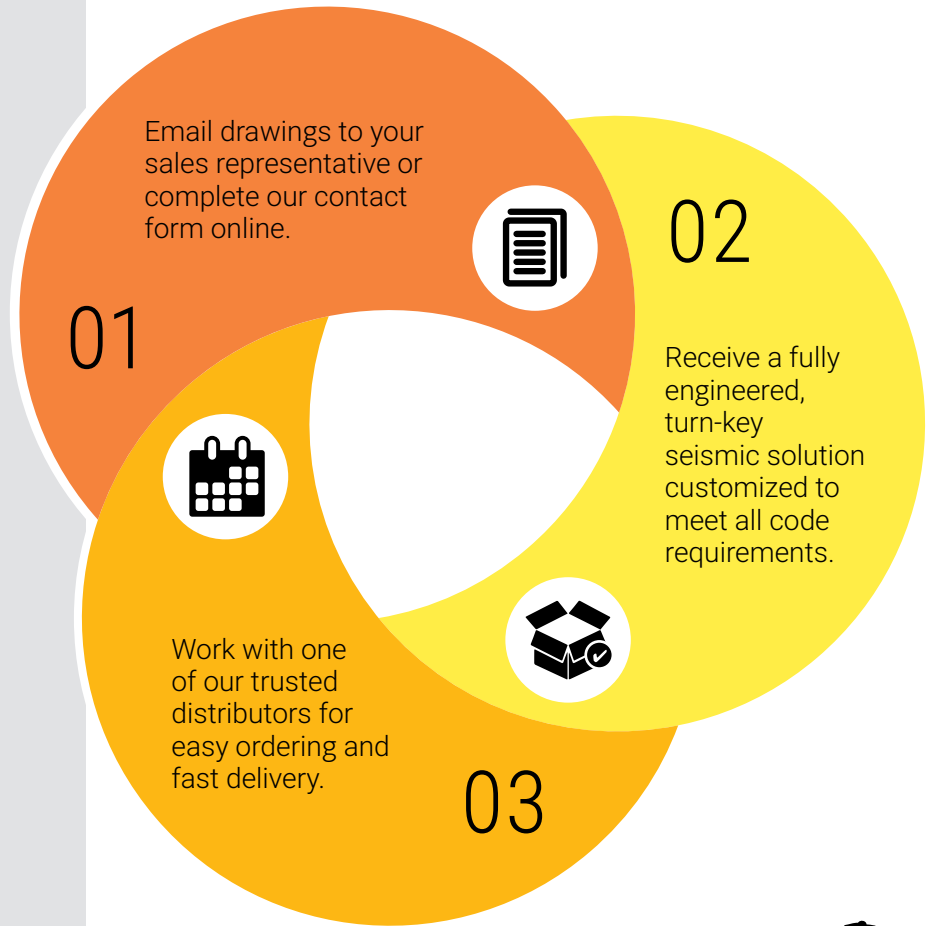

WE MAKE  
SEISMIC  
SIMPLE

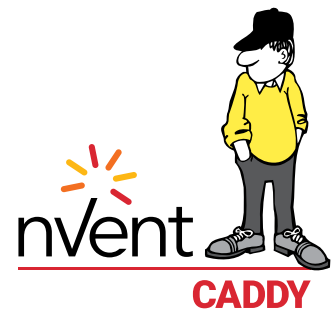



## ENGINEERING SERVICES

- Design optimization to meet your needs
- Bracing layouts with bill of material using code compliant products
- Stamped drawings

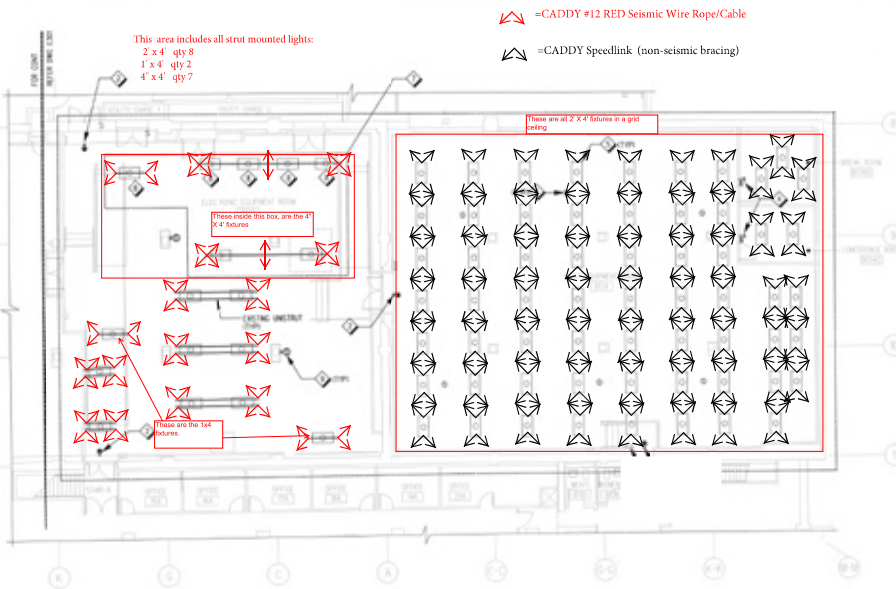

## CUSTOMER EXPERIENCE

- Quick turnaround
- Local availability through distributors
- In-market support from the local nVent CADDY sales team

“nVent’s seismic experts provide everything we need for a code compliant cable bracing system. Their patented, turn-key seismic solutions give us peace of mind that our building products are properly braced for a seismic event.”

Tim Barmeier  
Mechanical Supply Company

## PRODUCT SOLUTIONS

- Cable and rigid bracing solutions
- Innovative products
- Superior full range of bracing solutions



# nVent CADDY Seismic Bracing Systems Overview

## DETERMINING FACTORS IN BRACING

The requirements for seismic protection depend on the risk associated with the building considered as well as on how seismic is the zone in which the building is located. The higher the seismicity of the location and the greater the building occupancy, the more stringent the requirements. For example, a military or healthcare facility in a generally low seismic area will typically require bracing because of the building's importance to disaster recovery.



The majority of major earthquakes occur beneath the earth's surface around fault lines, the places where tectonic plates meet. Under pressure, the plates shift suddenly which causes rock to crack and movements in the earth's crust. The stored energy is released in the form of seismic waves of varying strength.

## Risk Category

**Category I:** Low hazard to human life, barns

**Category II:** Most buildings, residential, individual shops

**Category III:** High Occupancy, e.g. Stadiums, buildings containing hazardous materials

**Category IV:** Hospitals and essential facilities, Government buildings, military facilities

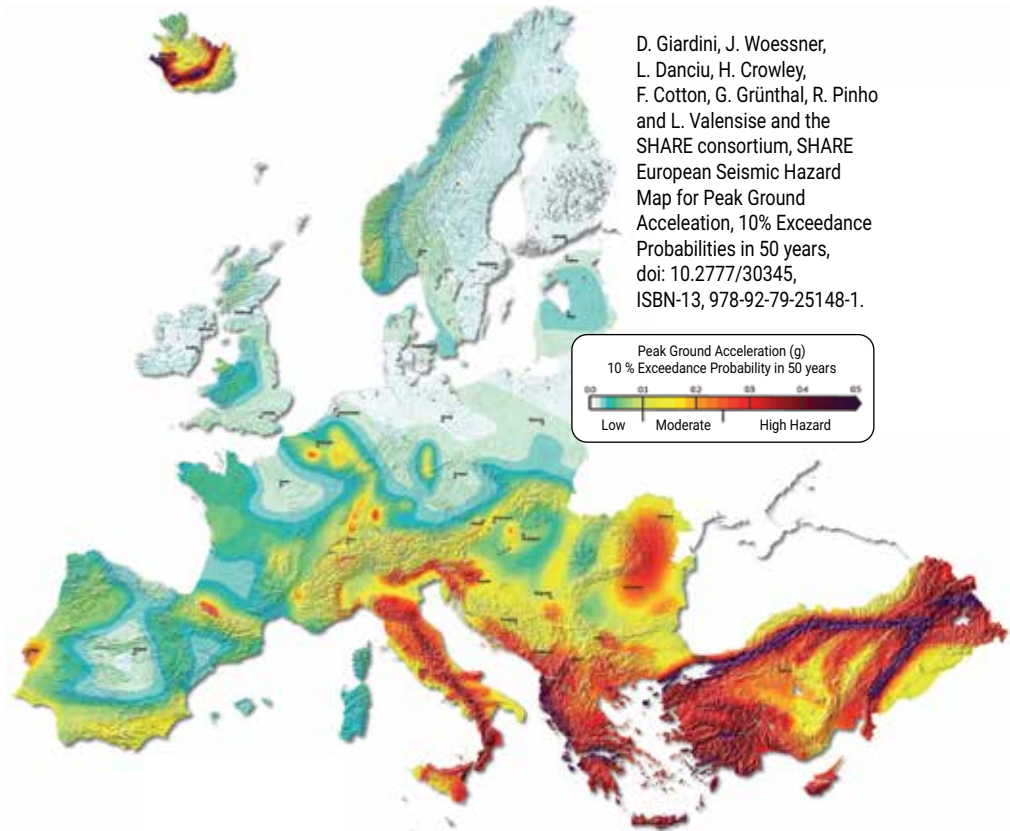

## WHAT NEEDS TO BE BRACED

- Hospitals
- Airports
- Power Plants
- Schools
- Data Centers
- Shelters
- Resorts
- Casinos
- Stadium
- Arenas
- Prisons
- Dams
- Water treatment
- Pharmaceutical
- Police stations
- Public utilities
- Government buildings



## COMMON COMPONENTS THAT REQUIRE SEISMIC BRACING

Suspended mechanical, electrical, plumbing components:

- Piping systems
- HVAC ductwork
- Bus ducts
- Cable trays
- Suspended equipment

Floor mounted, roof mounted and wall mounted:

- Panel boards
- Switchgears
- Generators
- Air conditioners
- Chillers
- Cooling towers
- Transformers
- Air handling units
- Pumps

Process equipment

Equipment with hazardous materials

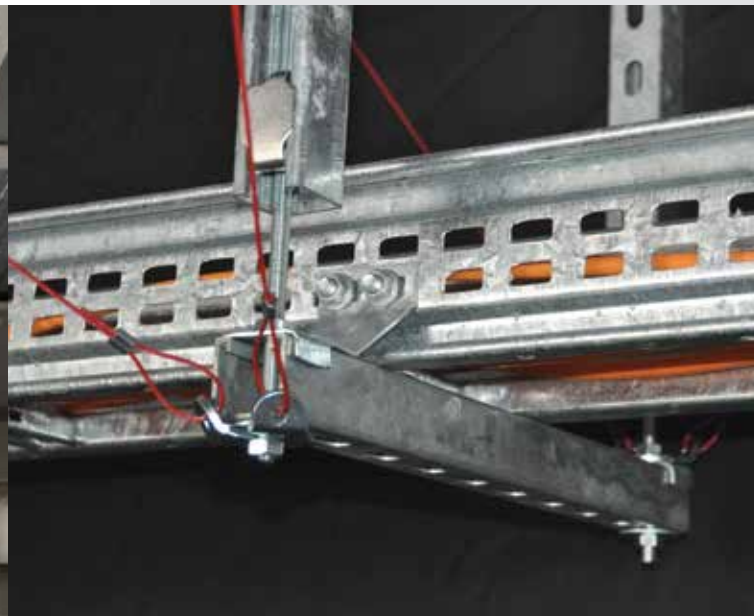



## THE NEED FOR BRACING

### Legal and Building Requirements

The need for earthquake protection of nonstructural building components is found in the structural design requirements of Eurocode 8 Part 1 (EN 1998-1): Design of structures for earthquake resistance – Part 1: General rules, seismic actions and rule for buildings, Section 4.3.5.1. These nonstructural building components are architectural, mechanical, electrical, and plumbing equipment and systems.

The technical Specification CEN/TS 17551:2021 to the European Norm EN12845 provides the guidelines and specifications to direct the design and the installation of seismic bracing for fixed firefighting automatic sprinkler systems. It can serve as a reference for other systems and equipment.

Chapter 13 of ASCE 7: Minimum Design Loads for Buildings and Other Structures of the American Society of Civil Engineers, which is the reference

standard in the United States for the International Building Code that contains the seismic design requirements for the architectural, mechanical and electrical nonstructural building components, can serve as a complementary reference for all systems and equipment

### EN 1998-1 (Eurocode 8 Part 1)

#### 4.3.5 Non-structural elements

##### 4.3.5.1 General

(1)P Non-structural elements (appendages of buildings (e.g. parapets, gables, antennae, mechanical appendages and equipment, curtain walls, partitions, railings) that might, in case of failure, cause risk to persons or affect the main structure of the building or services of critical facilities, shall, together with their supports, be verified to resist the design seismic action.

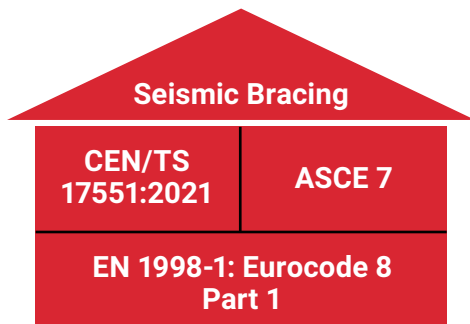

Guidelines and specifications direct the implementation of seismic bracing

Reference standards

Legally adopted building code requirements

Laws





# Table of Contents

## People, Property and Operation Continuity Protection

Earthquakes can lead to business disruption, causing damage to mechanical, HVAC, electrical, plumbing and fire protection systems or equipment. Differential movement of building systems during an earthquake may cause them to break, fall, or collide and damage other adjacent systems, damage assets and inventory, or injure people.

### Rigid Bracing ..... p. 14

Structural Attachments.....	14
Sway Braces.....	21
Replacement Nuts and Bolts .....	30
Lateral Telescoping Brace Assembly .....	31

### Cable Bracing ..... p. 32

Wire Spool.....	32
Oval Sleeve.....	33
Restraint Clips .....	33
Cable Cutters .....	32
Swaging Tools .....	35

### Rod Stiffeners ..... p. 36

nVent CADDY Quick Clip Rod Stiffener.....	36
Strut Rod Stiffener.....	36
Pipe Rod Stiffener .....	36

### Branch Line Restraint System ..... p. 37

Branch Line Restraint Pipe Attachment .....	37
Branch Line Restraint Structure Attachment to Steel .....	37
Branch Line Restraint Structure Attachment to Wood/Concrete .....	38
Branch Line Restraint Structure Attachment to Threaded Hole .....	38

### Related Products ..... p. 39

Additional nVent CADDY products frequently used when installing mechanical, electrical, or plumbing applications



# Rigid Bracing – Structural Attachments

## BAR JOIST ATTACHMENT

- Can be installed on bar joists or I-beams
- Thumb spring retainer allows for ease of positioning
- Snap-off bolt head helps enable easy installation and inspection of seismic sway braces
- No assembly required
- No loose parts
- Meets NFPA®-13 requirements for seismic sway bracing
- Meets CEN/TS 17551:2021 Requirements for Seismic Sway Bracing

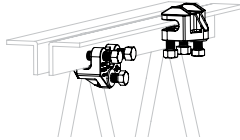
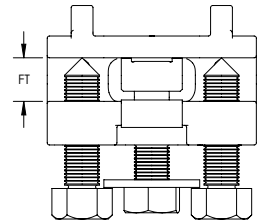
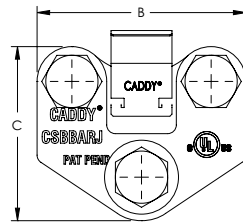
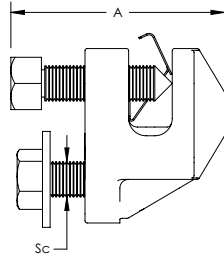

Material: Cast Iron  
Finish: Electrogalvanized



Part Number	Article Number	Flange Thickness FT	Screw Diameter SC	A	B	C
CSBBARJEG	404354	6.4 – 12.7 mm	1/2"	50.8 mm	76.2 mm	63.5 mm

UL Loads		
Part Numbers	Brace Member	Rating
CSBBARJEG with CSBUNIV050EG	25 mm - 50 mm EN10255H	4000 N
CSBBARJEG with CSBURC12	2.4 mm, 3.2 mm, 4.8 mm Wire Rope	4890 N

FM Loads					
Brace Direction	Service Pipe Size	Horizontal Capacity per Installation Angle from Vertical			
		30° - 44°	45° - 59°	60° - 74°	75° - 90°
Parallel	N/A	6270 N	9385 N	11300 N	12590 N
Perpendicular	N/A	7740 N	7605 N	9165 N	10230 N

# Rigid Bracing – Structural Attachments

## ADJUSTABLE I-BEAM ATTACHMENT

- No loose parts
- No assembly required
- Snap-off bolt head helps enable easy installation and inspection of seismic sway braces
- Meets NFPA®-13 requirements for seismic sway bracing
- Meets CEN/TS 17551:2021 Requirements for Seismic Sway Bracing

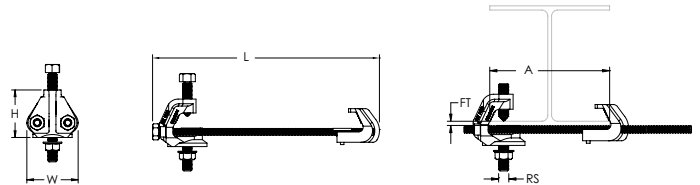

Material: Cast Iron  
Finish: Electrogalvanized



Part Number	Article Number	Flange Thickness FT	Rod Size RS	A	Height H	Length L	Width W
CSBIB075085EG	404365	6.4 – 19.1 mm	1/2"	100 – 216 mm	63.5 mm	304.8 mm	69.9 mm
CSBIB075145EG	404366	6.4 – 19.1 mm	1/2"	216 – 368 mm	63.5 mm	431.8 mm	69.9 mm
CSBIB125180EG	404367	19.1 – 31.8 mm	1/2"	100 – 457 mm	88.9 mm	546.1 mm	79.4 mm

UL Loads		
Part number	Brace Member	Rating
CSBIB075085EG with CSBUNIV050EG	25 mm - 50 mm EN10255H	4840 N
CSBIB075085EG with CSBURC12	2.4 mm, 3.2 mm, 4.8 mm Wire Rope	4890 N
CCSBIB075085EG with CSBNPC12	2.4 mm, 3.2 mm, 4.8 mm Wire Rope	6220 N
CSBIB075145EG with CSBUNIV050EG	25 mm - 50 mm EN10255H	4840 N
CSBIB075145EG with CSBURC12	2.4 mm, 3.2 mm, 4.8 mm Wire Rope	4890 N
CSBIB075145EG with CSBNPC12	2.4 mm, 3.2 mm, 4.8 mm Wire Rope	6220 N
CSBIB125180EG with CSBUNIV050EG	25 mm - 50 mm EN10255H	6090 N
CSBIB125180EG with CSBURC12	2.4 mm, 3.2 mm, 4.8 mm Wire Rope	4890 N
CSBIB125180EG with CSBNPC12	2.4 mm, 3.2 mm, 4.8 mm Wire Rope	6220 N

FM Loads					
Brace Direction	Service Pipe Size	Horizontal Capacity per Installation Angle from Vertical			
		30° - 44°	45° - 59°	60° - 74°	75° - 90°
Parallel	N/A	7205 N	7605 N	4495 N	4940 N
Perpendicular	N/A	7205 N	10230 N	12545 N	13965 N

# Rigid Bracing – Structural Attachments

## I-BEAM ATTACHMENT

- Snap-off bolt head helps enable easy installation and inspection of seismic sway braces
- Meets NFPA®-13 requirements for seismic sway bracing
- Meets CEN/TS 17551:2021 Requirements for Seismic Sway Bracing

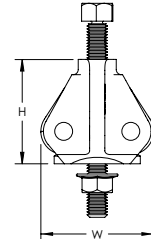
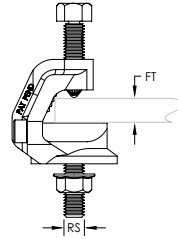

Material: Cast Iron  
Finish: Electrogalvanized



Part Number	Article Number	Flange Thickness FT	Rod Size RS	Height H	Width W
CSBBC075EG	404350	6.4 – 19.1 mm	1/2"	63.5 mm	69.9 mm

UL Loads		
Part number	Brace Member	Rating
CSBMA050050EG with CSBUNIV050EG	25 mm - 50 mm EN10255H	3020 N
CSBBC075EG with CSBURC12	2.4 mm, 3.2 mm, 4.8 mm Wire Rope	3550 N
CSBBC075EG with CSBNPC12	2.4 mm, 3.2 mm, 4.8 mm Wire Rope	3550 N

FM Loads					
Brace Direction	Service Pipe Size	Horizontal Capacity per Installation Angle from Vertical			
		30° - 44°	45° - 59°	60° - 74°	75° - 90°
Parallel	N/A	7,210 N	7,610 N	4,490 N	4,940 N
Perpendicular	N/A	5,290 N	7,470 N	5,160 N	5,690 N



# Rigid Bracing – Structural Attachments

## LOAD DOUBLER

- Disperses load over two anchors
- Minimizes the number of installed braces needed for concrete and wood structures
- Ideal for deck installations
- Use for both lateral and longitudinal sway brace applications
- Meets NFPA®-13 requirements for seismic sway bracing
- Meets CEN/TS 17551:2021 Requirements for Seismic Sway Bracing

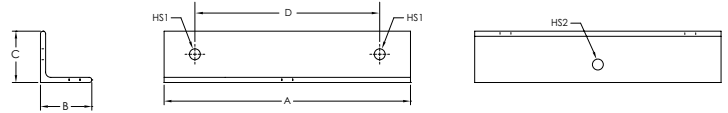

Material: Steel  
Finish: Electrogalvanized



Part Number	Article Number	Hole Size 1 HS1	Hole Size 2 HS2	A	B	C	D	UL Listed Load
CSBMA050050EG	404371	14 mm	14 mm	304.8 mm	63.5 mm	63.5 mm	228.6 mm	16,636 N
CSBMA050075EG	404372	20 mm	14 mm	304.8 mm	63.5 mm	63.5 mm	228.6 mm	16,636 N

Mount to structure using holes indicated in HS1.

UL Loads		
Part number	Brace Member	Rating
CSBMA050050EG with CSBUNIV050EG	25 mm - 50 mm EN10255H	3020 N
CSBMA050050EG with CSBURC12	2.4 mm, 3.2 mm, 4.8 mm Wire Rope	4890 N
CSBMA050050EG with CSBNPC12	2.4 mm, 3.2 mm, 4.8 mm Wire Rope	5780 N
CSBMA050075EG with CSBUNIV050EG	25 mm - 50 mm EN10255H	3020 N
CSBMA050075EG with CSBURC12	2.4 mm, 3.2 mm, 4.8 mm Wire Rope	4890 N
CSBMA050075EG with CSBNPC12	2.4 mm, 3.2 mm, 4.8 mm Wire Rope	5780 N

FM Loads				
Part Number	Horizontal Capacity per Installation Angle from Vertical			
	30° - 44°	45° - 59°	60° - 74°	75° - 90°
CSBMA050050EG	14,630 N	20,100 N	24,640 N	27,570 N
CSBMA050075EG	14,630 N	20,100 N	24,640 N	27,570 N

# Rigid Bracing – Structural Attachments

## UNIVERSAL STRUCTURAL ATTACHMENT

- Universal design allows one product to attach directly to concrete, wood, bar joist or I-beam adapters
- Snap-off bolt head helps enable easy installation and inspection of seismic sway braces
- Use for both lateral and longitudinal sway brace applications
- Works with 1" through 2" brace pipes and 1/4" angle iron braces to reduce inventory
- Center bolt does not require tightening
- Meets NFPA®-13 requirements for seismic sway bracing
- Meets CEN/TS 17551:2021 Requirements for Seismic Sway Bracing

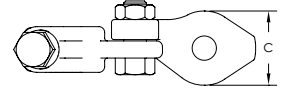
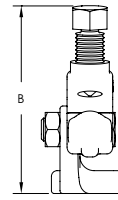
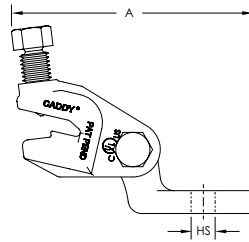

Part Number	Article Number	Hole Size HS	A	B	C
CSBUNIV050EG	404407	14 mm	133.4 mm	101.6 mm	41.4 mm
CSBUNIV075EG	404409	21 mm	133.4 mm	101.6 mm	41.4 mm

UL Loads		
Part number	Brace Member	Rating
CSBUNIV050EG	25 mm - 50 mm EN10255H	6090 N
CSBUNIV075EG	25 mm - 50 mm EN10255H	9090 N

FM Loads					
Brace Type	Service Pipe Size	Horizontal Capacity per Installation Angle from Vertical			
		30° - 44°	45° - 59°	60° - 74°	75° - 90°
Pipe	N/A	7,205 N	10,230 N	12,545 N	13,965 N

# Rigid Bracing – Structural Attachments

## UNIVERSAL STRUCTURAL BRACKET, STRUT BRACE

- Used for installations where strut brace is perpendicular to structure
- One wrench size fits all required hardware, eliminating the need to change tools
- Shear-off head helps ensure correct torque and simplifies inspection
- Compatible with brace members of 41x41x2,5 mm strut type A

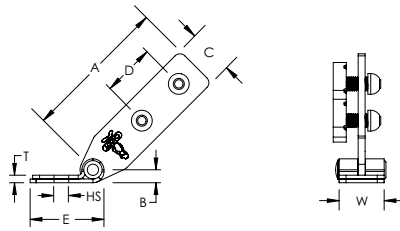
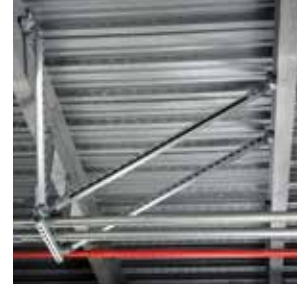

Note: This part is used in conjunction with Sway Brace CSBR2 – See p. 28

Material: Steel  
Finish: Electrogalvanized



Part Number	Article Number	Hole Size HS	Width W	Thickness T	A	B	C	D	E
CSBUS1	404568	14.3 mm	40.6 mm	6.4 mm	133.4 mm	12.7 mm	40.6 mm	50.8 mm	66 mm
CSBUS2	404569	20.6 mm	40.6 mm	6.4 mm	133.4 mm	12.7 mm	40.6 mm	50.8 mm	66 mm

Cut length for strut member is +/- 25 mm of measured length.

Part Number	Brace Member	FM Loads			
		Horizontal Capacity per Installation Angle from Vertical			
		30° - 44°	45° - 59°	60° - 74°	75° - 90°
CSBUS1	41 x 41 Strut Channel	8940 N	12630 N	15210 N	16940 N
CSBUS2	41 x 41 Strut Channel	8940 N	12630 N	15210 N	16940 N

# Rigid Bracing – Structural Attachments

## STRUT SEISMIC HINGE BRACKET ASSEMBLY

- Used for installations where strut brace is parallel to structure
- One wrench size fits all required hardware, eliminating the need to change tools
- Shear-off head helps ensure correct torque and simplifies inspection
- Compatible with brace members of 41x41x2,5 mm strut type A



Note: This part is used in conjunction with Sway Brace CSBR2 – See p. 28

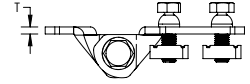
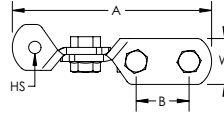

Material: Steel  
Finish: Electrogalvanized



Part Number	Article Number	Hole Size HS	Width W	Thickness T	A	B
CSBUS1PA	404602	14.3 mm	40.6 mm	6.4 mm	177.8 mm	47.8 mm
CSBUS2PA	404603	20.6 mm	40.6 mm	6.4 mm	177.8 mm	47.8 mm

Part Number	Brace Member	FM Loads			
		Horizontal Capacity per Installation Angle from Vertical			
		30° - 44°	45° - 59°	60° - 74°	75° - 90°
CSBUS1PA	41 x 41 Strut Channel	5160 N	8290 N	8290 N	7470 N
CSBUS2PA	41 x 41 Strut Channel	5160 N	8290 N	8290 N	7470 N

## STRUT SEISMIC HINGE

- Complete hinge assembly
- Ideal for attaching sway bracing to MEP system supports
- Attaches to strut trapezes and to structure

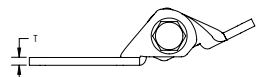
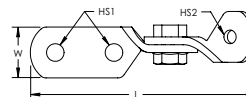

Material: Steel  
Finish: Electrogalvanized

Part Number	Article Number	Hole Size 1 HS1	Hole Size 2 HS2	Length L	Width W	Thickness T
CSBSH00375EG	404463	14 mm	11 mm	179.8 mm	41.3 mm	6.4 mm
CSBSH00500EG	404464	14 mm	14 mm	179.8 mm	41.3 mm	6.4 mm
CSBSH00625EG	404465	14 mm	17 mm	179.8 mm	41.3 mm	6.4 mm
CSBSH00750EG	404466	14 mm	21 mm	179.8 mm	41.3 mm	6.4 mm



# Rigid Bracing – Sway Braces, Single Pipe

## UNIVERSAL SWAY BRACE

- Use for both lateral and longitudinal sway brace applications
- Unique slotted holes provide for easy slip-on installation eliminating loose hardware
- Snap-off bolt head helps enable easy installation and inspection of seismic sway braces
- Works with 1" through 2" brace pipes to reduce inventory
- Meets NFPA®-13 requirements for seismic sway bracing
- FM® Specification Tested
- Meets CEN/TS 17551:2021 requirements for Seismic Sway Bracing

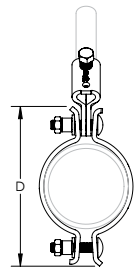
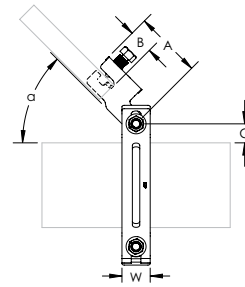

Material: Steel  
Finish: Electrogalvanized



Part Number	Article Number	Pipe Size	NB/DN	Brace Pipe Size	Brace NB/DN
CSB1200	404551	12"	300	1" – 2"	25 – 50 mm

Width	Angle	A	B	C	D
38 mm	45°	91 mm	33 mm	25 mm	429 mm

FM Loads								
Part Number	Horizontal Capacity per Installation Angle from Vertical							
	Lateral				Longitudinal			
	30° - 44°	45° - 59°	60° - 74°	75° - 90°	30° - 44°	45° - 59°	60° - 74°	75° - 90°
0.188" Wall and Sch 40 Service Pipes								
CSB1200	7470 N	10540 N	12940 N	14500 N	7110 N	8270 N	9960 N	11520 N

# Rigid Bracing – Sway Braces, Single Pipe

## STANDARD UNIVERSAL SWAY BRACE

- Use for both lateral and longitudinal sway brace applications
- Snap-off bolt head helps enable easy installation and inspection of seismic sway braces
- Works with 1" through 2" brace pipes and 1/4" angle iron braces to reduce inventory
- Slotted design grabs service pipe for added gripping strength
- Meets NFPA®-13 requirements for seismic sway bracing
- Meets CEN/TS 17551:2021 requirements for seismic sway bracing

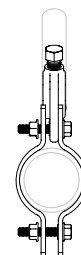
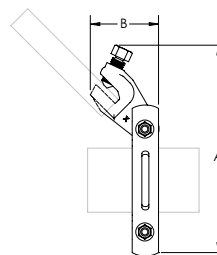

Material: Steel; Cast Iron  
Finish: Electrogalvanized



Part Number	Article Number	Pipe Size	NB/DN	A	B
CSBSTU0100EG	404385	1"	25	174.6 mm	25.0 mm
CSBSTU0125EG	404386	1 1/4"	32	187.4 mm	25.4 mm
CSBSTU0150EG	404387	1 1/2"	40	196.9 mm	25.4 mm
CSBSTU0200EG	404388	2"	50	206.4 mm	30.2 mm
CSBSTU0250EG	404389	2 1/2"	65	225.4 mm	30.2 mm
CSBSTU0300EG	404390	3"	80	238.1 mm	30.2 mm
CSBSTU0400EG	404391	4"	100	269.9 mm	38.1 mm
CSBSTU0500EG	404392	5"	125	308.0 mm	38.1 mm
CSBSTU0600EG	404393	6"	150	346.1 mm	50.8 mm
CSBSTU0800EG	404394	8"	200	400.1 mm	50.8 mm
CSBSTU1000EG	404395	10"	250	457.2 mm	50.8 mm

UL Loads (Listed for Restraints)			
Part Number	Dyna-Flow® Service Pipe	Sch 10 Service Pipe	Sch 40 Service Pipe
CSBSTU0100xx	N/A	2910 N	2910 N
CSBSTU0125xx	2910 N	2910 N	2910 N
CSBSTU0150xx	2910 N	2910 N	2910 N

UL Load Rating			
Part Number	EN 10250 H service pipe EN 10255 M service pipe	EN 10250 H service pipe EN 10255 M service pipe	Bracing Member
	Lateral	Longitudinal	
CSBSTU0100EG	5340 N	N/A	25 mm to 50 mm EN10255H
CSBSTU0125EG	5340 N	N/A	25 mm to 50 mm EN10255H
CSBSTU0150EG	5340 N	N/A	25 mm to 50 mm EN10255H
CSBSTU0200EG	5340 N	N/A	25 mm to 50 mm EN10255H
CSBSTU0250EG	9100 N	6115 N	25 mm to 50 mm EN10255H
CSBSTU0300EG	7115 N	3110 N	25 mm to 50 mm EN10255H
CSBSTU0400EG	9100 N	6115 N	25 mm to 50 mm EN10255H
CSBSTU0500EG	9100 N	6115 N	25 mm to 50 mm EN10255H
CSBSTU0600EG	9100 N	4890 N	25 mm to 50 mm EN10255H
CSBSTU0800EG	9100 N	6115 N	25 mm to 50 mm EN10255H
CSBSTU1000EG	9100 N	8385 N	25 mm to 50 mm EN10255H

FM Load Ratings								
Part Number	Horizontal Capacity per Installation Angle from Vertical							
	Perpendicular to Structure				Parallel to Structure			
	30° - 44°	45° - 59°	60° - 74°	75° - 90°	30° - 44°	45° - 59°	60° - 74°	75° - 90°
EN 10255 L, EN10255 M and EN 10255 H Service Pipes								
CSBSTU0100xx	3825 N	5425 N	6670 N	7430 N	4315 N	3200 N	3825 N	4270 N
CSBSTU0125xx	3825 N	5425 N	6670 N	7430 N	4315 N	3200 N	3825 N	4270 N
CSBSTU0150xx	3825 N	5425 N	6670 N	7430 N	4315 N	3200 N	3825 N	4270 N
CSBSTU0200xx	6805 N	9610 N	11790 N	13165 N	3870 N	3070 N	3690 N	4136 N
CSBSTU0250xx	6805 N	9610 N	11790 N	13165 N	3870 N	3070 N	3690 N	4136 N
CSBSTU0300xx	6805 N	9610 N	11790 N	13165 N	3870 N	3070 N	3690 N	4136 N
CSBSTU0400xx	6985 N	9875 N	12100 N	13480 N	6895 N	6185 N	7475 N	8320 N
CSBSTU0500xx	6985 N	9875 N	12100 N	13480 N	6895 N	6185 N	7475 N	8320 N
CSBSTU0600xx	8805 N	12500 N	15300 N	17080 N	6540 N	5205 N	6270 N	6985 N
4.8 mm and EN 10255 H Service Pipes								
CSBSTU0800xx	9075 N	12855 N	15745 N	17570 N	5340 N	7560 N	9295 N	10365 N
CSBSTU1000xx	9075 N	12855 N	15745 N	17570 N	5340 N	7560 N	9295 N	10365 N

# Rigid Bracing – Sway Braces, Single Pipe

## QUICK GRIP JR. LATERAL SWAY BRACE

- Easy two-step installation eliminates extra trips between structure and service pipe
- Works with 25 mm and 32 mm brace pipes to reduce inventory
- Snap-off bolt head helps enable easy installation and inspection of seismic sway braces
- Meets NFPA®-13 requirements for seismic sway bracing
- Meets CEN/TS 17551:2021 requirements for seismic sway bracing

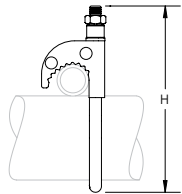
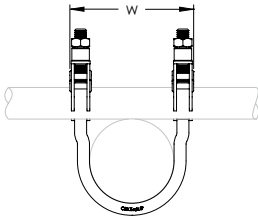

Material: Steel  
 Finish: Electrogalvanized



Part Number	Article Number	Pipe Size	NB/DN	Height H	Width W
CSBQIKCL0100EG	404373	1"	25	130.2 mm	65.3 mm
CSBQIKCL0125EG	404374	1 1/4"	32	136.5 mm	74.4 mm
CSBQIKCL0150EG	404375	1 1/2"	40	142.9 mm	80.2 mm
CSBQIKCL0200EG	404376	2"	50	161.9 mm	92.3 mm



UL Load Rating (Listed for Restraint)			
Part Number	Service Pipe Schedule	Lateral	
		25 mm Brace Pipe	32 mm Brace Pipe
CSBQIKCL0100EG	EN 10255 L	N/A	N/A
	EN 10255 M	2910 N	2910 N
	EN 10255 H	2910 N	2910 N
CSBQIKCL0125EG	EN 10255 L	2910 N	2400 N
	EN 10255 M	2910 N	2400 N
	EN 10255 H	2910 N	2400 N
CSBQIKCL0150EG	EN 10255 L	3300 N	2910 N
	EN 10255 M	3300 N	2910 N
	EN 10255 H	3300 N	2910 N
CSBQIKCL0200EG	EN 10255 L	3300 N	2400 N
	EN 10255 M	3300 N	2400 N
	EN 10255 H	3300 N	2400 N

FM Loads					
Part Number	Service Pipe Schedule	Lateral			
		Horizontal Capacity per Installation Angle from Vertical			
		30° - 44°	45° - 59°	60° - 74°	75° - 90°
CSBQIKCL0100EG	EN10255 L (Lightwall)	1290 N	1830 N	2200 N	2445 N
	EN10255 M (10)	665 N	935 N	1245 N	1400 N
	EN10255 H (40)	2115 N	2960 N	3670 N	4115 N
CSBQIKCL0125EG	EN10255 L (Lightwall)	1290 N	1830 N	2200 N	2445 N
	EN10255 M (10)	665 N	935 N	1245 N	1400 N
	EN10255 H (40)	2115 N	2960 N	3670 N	4115 N
CSBQIKCL0150EG	EN10255 L (Lightwall)	1290 N	1830 N	2200 N	2445 N
	EN10255 M (10)	665 N	935 N	1245 N	1400 N
	EN10255 H (40)	2115 N	2960 N	3670 N	4115 N
CSBQIKCL0200EG	EN10255 L (Lightwall)	1735 N	2445 N	2980 N	3335 N
	EN10255 M (10)	1555 N	2225 N	2760 N	3070 N
	EN10255 H (40)	2180 N	3070 N	3780 N	4225 N

# Rigid Bracing – Sway Braces, Single Pipe

## QUICK GRIP LATERAL SWAY BRACE

- Easy two-step installation eliminates extra trips between structure and service pipe
- Works with 25 mm and 32 mm brace pipes to reduce inventory
- Yellow tips provide a visual indicator that the bolts have been properly torqued
- Easy installation with an impact wrench from the bottom side of the clamp
- Meets NFPA®-13 requirements for seismic sway bracing
- Meets CEN/TS 17551:2021 requirements for seismic sway bracing

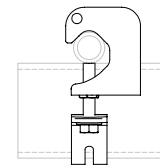
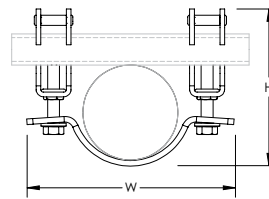

Material: Steel  
Finish: Electrogalvanized



Part Number	Article Number	Pipe Size	NB/DN	Height H	Width W	Certifications
CSBQG0250MEG	404475	2 1/2"	65	138.1 – 148.6 mm	172.0 mm	FM Approved, Seismic
CSBQG0300EG	404469	3"	80	155.0 – 165.5 mm	190.0 mm	cULus, FM Approved, Seismic, OSHPD
CSBQG0400EG	404470	4"	100	180.4 – 190.9 mm	222.0 mm	cULus, FM Approved, Seismic, OSHPD
CSBQG0600EG	404472	6"	150	235.5 – 244.9 mm	298.0 mm	cULus, FM Approved, Seismic, OSHPD
CSBQG0800EG	404473	8"	200	289.2 – 300.0 mm	351.8 mm	cULus, FM Approved, Seismic, OSHPD

Load capacity according UL			
Part Number	Service Pipe Schedule	Lateral	
		25 mm Brace Pipe	32 mm Brace Pipe
CSBQG0250EG CSBQG0250MEG	EN 10255 L	6115 N	6115 N
	EN 10255 M	6115 N	6115 N
	EN 10255 H	6115 N	6115 N
CSBQG0300EG	EN 10255 L	6115 N	6115 N
	EN 10255 M	6115 N	6115 N
	EN 10255 H	6115 N	6115 N
CSBQG0400EG	EN 10255 L	6115 N	6115 N
	EN 10255 M	6115 N	6115 N
	EN 10255 H	6115 N	6115 N
CSBQG0600EG	EN 10255 L	6115 N	6115 N
	EN 10255 M	6115 N	6115 N
	EN 10255 H	6115 N	6115 N
CSBQG0800EG	EN 10255 L	6115 N	6115 N
	EN 10255 M	6115 N	6115 N
	EN 10255 H	6115 N	6115 N

FM Loads					
Part Number	Service Pipe Schedule	Lateral			
		Horizontal Capacity per Installation Angle from Vertical			
		30° - 44°	45° - 59°	60° - 74°	75° - 90°
CSBQG0250EG/ CSBQG0250MEG	EN10255 L (Lightwall)	6270 N	8895 N	10900 N	12190 N
	EN10255 M (10)	6270 N	8895 N	10900 N	12190 N
	EN10255 H (40)	6270 N	8895 N	10900 N	12190 N
CSBQG0300EG	EN10255 L (Lightwall)	5295 N	7475 N	9163 N	10230 N
	EN10255 M (10)	5295 N	7475 N	9163 N	10230 N
	EN10255 H (40)	5295 N	7475 N	9163 N	10230 N
CSBQG0400EG	EN10255 L (Lightwall)	5295 N	7475 N	9163 N	10230 N
	EN10255 M (10)	5295 N	7475 N	9163 N	10230 N
	EN10255 H (40)	5295 N	7475 N	9163 N	10230 N
CSBQG0600EG	EN10255 L (Lightwall)	3870 N	5470 N	6715 N	7515 N
	EN10255 M (10)	3870 N	5470 N	6715 N	7515 N
	EN10255 H (40)	4315 N	6095 N	7475 N	8320 N
CSBQG0800EG	4.8 mm (Wall Thickness)	3515 N	4940 N	6050 N	6760 N
	EN10255 H (40)	3515 N	4940 N	6050 N	6760 N

# Rigid Bracing – Sway Braces

## TRAPEZE SWAY BRACE, STRUT

- Seismically braces trapeze hangers
- Retrofit ability allows for the brace to be installed after the trapeze assembly is installed
- Compatible with brace members of 41x41x2,5 mm strut type A
- One wrench size fits all required hardware, eliminating the need to change tools
- Shear-off head helps ensure correct torque and simplifies inspection
- FM® Specification Tested

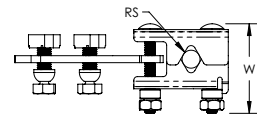
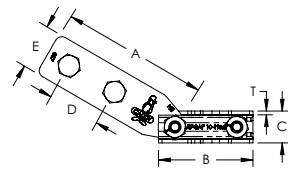

Note: This part is used in conjunction with Structural Attachment CSBUS1 or CSBUS2 – See p. 19

Material: Steel  
Finish: Electrogalvanized

Part Number	Article Number	Rod Size RS	Width W	Thickness T	A	B	C	D	E
CSBR2	404567	M10, M12, M16, M20	81.3 mm	3.4 mm	133.4 mm	86.4 mm	29 mm	47.8 mm	41.1 mm

Cut length for strut member is +/- 25 mm of measured length.

Part Number	Brace Member	FM Loads			
		Horizontal Capacity per Installation Angle from Vertical			
		30° - 44°	45° - 59°	60° - 74°	75° - 90°
CSBR2	41 x 41 Strut Channel	4585 N	8060 N	8895 N	9920 N

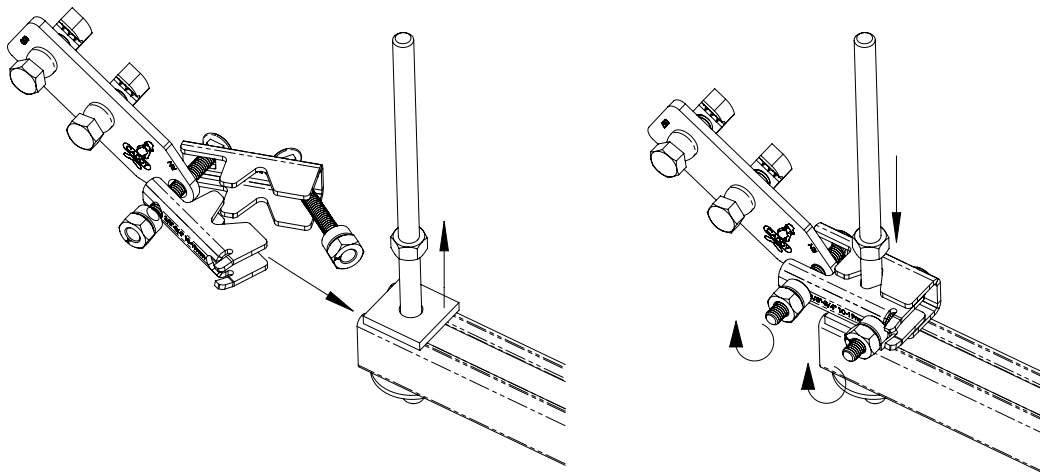



# Rigid Bracing – Sway Braces

## TRAPEZE SWAY BRACE, PIPE

- Seismically braces trapeze hangers
- Retrofit ability allows for the brace to be installed after the trapeze assembly is installed
- Works with brace members of schedule 40 pipe, EMT conduit, and rigid conduit
- One wrench size fits all required hardware, eliminating the need to change tools
- Shear-off head helps ensure correct torque and simplifies inspection
- FM® Specification Tested

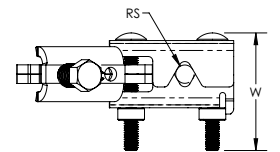
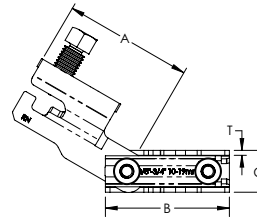

Note: This part is used in conjunction with Structural Attachment CSBUNIVxxxxx – See p. 18

Material: Steel  
Finish: Electrogalvanized

Part Number	Article Number	Rod Size RS	Width W	Thickness T	A	B	C
CSBR1	404566	M10, M12, M16, M20	81.3 mm	3.4 mm	88.9 mm	86.4 mm	29 mm

Part Number	Brace Member	FM Loads			
		Horizontal Capacity per Installation Angle from Vertical			
		30° - 44°	45° - 59°	60° - 74°	75° - 90°
CSBR1	EN 10255 H	3360 N	4930 N	7730 N	7730 N

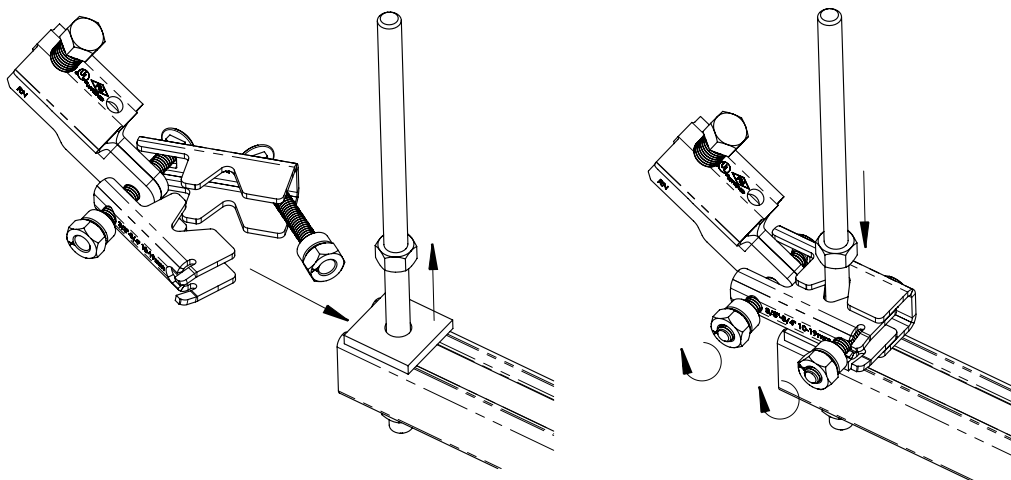

# Rigid Bracing – Sway Braces

## CONE POINT SHEAR BOLT

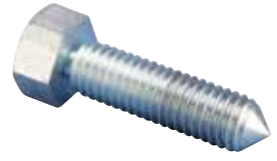

Material: Steel  
Finish: Electrogalvanized

Part Number	Article Number	For Use With These Products
CSBBARJSB50EG	402502	Bar Joist Attachment
CSBIBSB50EG	402501	I-Beam Attachment
CSBUNIVSB62EG	402503	Universal Structural Attachment, Universal Sway Brace (1" - 10" sizes)

## SELF DRILLING SCREW

- Replacement screw for Lateral Telescoping Brace Assembly

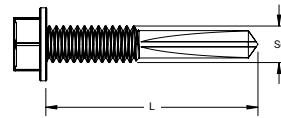

Material: Steel  
Finish: STALGARD®

Part Number	Article Number	Screw Diameter Sc	Screw Length L	Wrench Size
CSBTS1	404317	5 mm	32 mm	8 mm

## RIVET HEAD SHEAR BOLT

- One wrench size fits all required hardware, eliminating the need to change tools

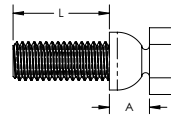

Material: Steel  
Finish: Electrogalvanized

Part Number	Article Number	For Use With These Products	Width W	Screw Length L	A
CSBSBR50EG	404578	Strut Seismic Hinge Bracket Assembly Trapeze Sway Brace, Strut Universal Structural Bracket, Strut Brace	19 mm	31.8 mm	13.2 mm

## SHEAR NUT



Material: Steel  
Finish: Electrogalvanized

Part Number	Article Number	For Use With These Products
CSBIBSN37EG	402500	Adjustable I-Beam Attachment
CSBQIKCLSN37EG	402505	Quick Grip Jr. Lateral Sway Brace

# Rigid Bracing

## LATERAL TELESCOPING BRACE ASSEMBLY

- Complete, out of the box assembly is compatible with both steel (IPS) and CPVC piping
- Telescoping brace member eliminates the need to cut pipe, minimizing waste and allowing one person to effectively complete the installation
- Easy “push-to-install” nVent CADDY Rod Lock feature allows the V-bolt to assemble quickly, and helps eliminate the risk of compressing CPVC pipe
- Length of telescoping lateral brace is fixed by installing the included self-drilling screw
- Electrogalvanized coating throughout the entire assembly provides superior corrosion resistance, and eliminates the risk of exposing CPVC pipe to any harmful oils or residue
- Designed to reduce the installation time of a complete brace by up to 80%
- Design allows center loading of brace on the service pipe
- Meets requirements of NFPA® 13
- FM® Specification Tested
- Certified chemically compatible with CPVC piping systems
- Meets CEN/TS 17551:2021 Requirements for Seismic Sway Bracing

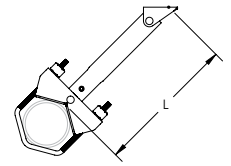
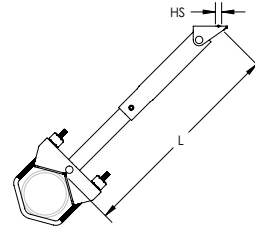

Material: Steel  
Finish: Electrogalvanized



Part Number	Article Number	Brace Length L	Pipe Size	Pipe Size	Hole Size HS	Wrench Size	UL Listed Load
CSBT1	404300	0.30 – 0.46 m	1" – 4"	25 – 100	12.7 mm	8 mm	5,780 N
CSBT2	404301	0.46 – 0.91 m	1" – 4"	25 – 100	12.7 mm	8 mm	5,780 N

UL Listed Load applies to Sch 40, Sch 10, Youngstown Tube Fire-Flo (1-1/2" to 4"), Bull Moose Eddy Flo (1-1/4" to 4"), and Wheatland Mega Flow (1-1/4" to 4") service pipes.

Wrench Size represents the hex size used to tighten the self-drilling screw.

# Cable Bracing

## WIRE SPOOL

- Cut to length as needed
- Pre-stretched restraint cable
- Certified chemically compatible with CPVC piping systems
- Meets CEN/TS 17551:2021 requirements for Seismic Sway Bracing



Material: Steel  
Finish: Pregalvanized; Painted



Part Number	Article Number	Brace Size	Diameter	Cable Length	UL Listed Load Rating	Color
CSB12CBL	402190	#12	2.4 mm	76.2 m	1850 N	Red
CSB18CBL	402191	#18	3.2 mm	76.2 m	3430 N	White
CSB36CBL	402192	#36	4.8 mm	76.2 m	8490 N	Blue

\* Cable is powder coated.

## WIRE SPOOL, STAINLESS STEEL

- Cut to length as needed
- Pre-stretched restraint cable
- Certified chemically compatible with CPVC piping systems



Material: Stainless Steel 316 (EN 1.4401)

Part Number	Article Number	Brace Size	Diameter	Cable Length	Safety Factor 2.2 Load Rating
CSB12CBLSS	402510	#12	2.4 mm	76.2 m	1410 N
CSB18CBLSS	402511	#18	3.2 mm	76.2 m	2750 N
CSB36CBLSS	402512	#36	4.8 mm	76.2 m	5860 N

## CABLE CUTTER

- Designed to reduce cable fraying



SLWC



CSBC48

Material: Steel

Part Number	Article Number	Brace Size	Cable Diameter
SLWC	195853	#12 (Red), #18 (White)	-
CSBC48	402536	#36 (B)	6 mm Max



# Cable Bracing

## OVAL SLEEVE

- Creates secure loop ends
- Swage with swaging tools



Part Number	Article Number	Brace Size
Material: Copper   Finish: Electrogalvanized		
CSB12SLVB	402194	#12 (Red)
CSB18SLVB	402195	#18 (White)
CSB36SLVB	402196	#36 (Blue)

Part Number	Article Number	Brace Size
Material: Stainless Steel 316 (EN 1.4401)		
CSB12SLVBSS	402514	#12 (Red)
CSB18SLVBSS	402515	#18 (White)
CSB36SLVBSS	402516	#36 (Blue)

Two side-by-side swages required on #12 and #18 cable. Three side-by-side swages required on #36 cable. Check swage with gauge (not included).

## UNIVERSAL RESTRAINT CLIP

- Attaches cable brace to structure
- Meets CEN/TS 17551:2021 requirements for Seismic Sway Bracing

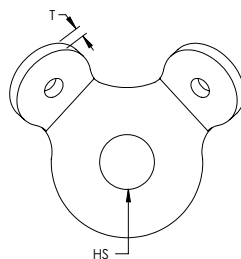

Part Number	Article Number	Brace Size	Hole Size HS	Thickness T	UL Listed Load Rating	Certifications
Material: Steel   Finish: Electrogalvanized						
CSBURC38	402198	#12, #18, #36	11 mm	4.27 mm	3430 N	UL
CSBURC12	402199	#12, #18, #36	14 mm	4.27 mm	3430 N	UL
CSBURC58	402200	#12, #18, #36	17 mm	4.27 mm	3430 N	UL
CSBURC34	402519	#12, #18, #36	21 mm	4.27 mm	7120 N	UL
CSBURC78	402520	#12, #18, #36	24 mm	4.27 mm	7120 N	UL
Material: Stainless Steel 316 (EN 1.4401)						
CSBURC38SS	402522	#12, #18, #36	11 mm	4.27 mm	2750 N	-
CSBURC12SS	402523	#12, #18, #36	14 mm	4.27 mm	2750 N	-
CSBURC58SS	402564	#12, #18, #36	17 mm	4.27 mm	2750 N	-

Mount to the structure using the center hole. Loop cable through the holes in the bent tabs and swage in place.

# Cable Bracing

## UNIVERSAL RESTRAINT CLIP, SLOTTED

- Slotted design ideal for attaching to existing threaded rod on trapezes
- Meets CEN/TS 17551:2021 requirements for Seismic Sway Bracing

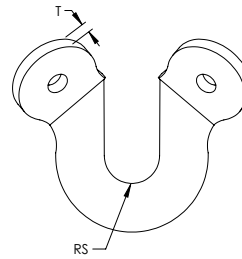

Material: Steel  
Finish: Electrogalvanized

Part Number	Article Number	Brace Size	Rod Size RS	Thickness T	UL Listed Load Rating
CSBURCR38	402201	#12, #18	M10	4.27 mm	3430 N
CSBURCR12	402202	#12, #18	M12	4.27 mm	3430 N
CSBURCR58	402203	#12, #18	M16	4.27 mm	3430 N

## NO PRY CLIP

- Eliminates prying effect on fasteners and anchors
- Meets CEN/TS 17551:2021 requirements for Seismic Sway Bracing

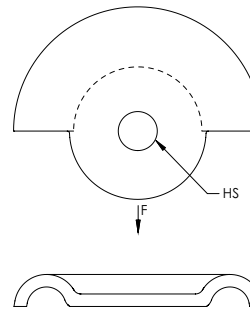

Material: Steel  
Finish: Electrogalvanized



Part Number	Article Number	Brace Size	Hole Size HS	UL Listed Load Rating
CSBNPC38	402528	#12, #18, #36	11 mm	8490 N
CSBNPC12	402208	#12, #18, #36	14 mm	8490 N
CSBNPC58	402529	#12, #18, #36	17 mm	8490 N

# Cable Bracing

## BATTERY-OPERATED SWAGING TOOL

- Battery-operated tool provides consistent swaging
- Provides less strenuous installation when compared to manual swaging tools
- Cordless design allows installers to easily move around the job site
- Compatible with large diameter cables



Material: Steel

Part Number	Article Number	Brace Size
CSBBS121836	402534	#12 (Red), #18 (White), #36 (Blue)

## MANUAL SWAGING TOOL

Material: Steel



Part Number	Article Number	Brace Size
CSB12SBHS	404461	#12 (Red)

## MULTI-SIZE MANUAL SWAGING TOOL

Material: Steel



Part Number	Article Number	Brace Size
CSB3346SB	402209	#12 (Red), #18 (White), #36 (Blue)

# Rod Stiffeners

## NVENT CADDY QUICK CLIP ROD STIFFENER

- Secures strut channel to threaded rod for stiffening
- One hand, snap-in place installation
- No tools or bolt tightening required

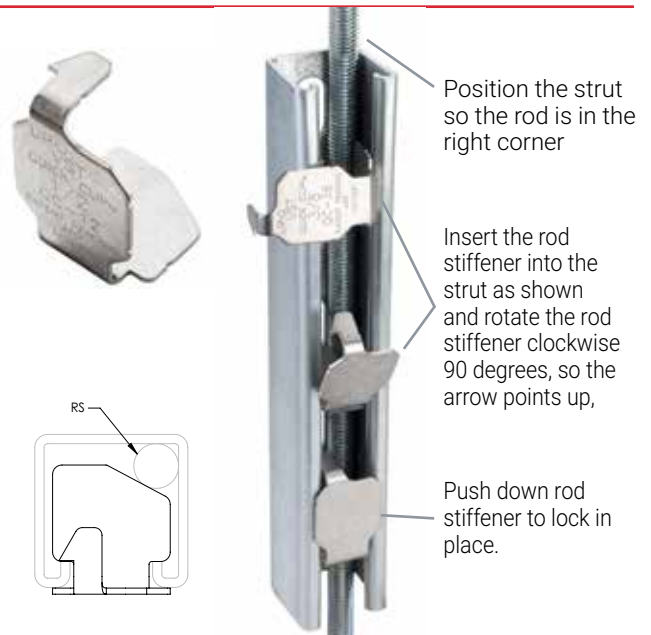

Material: Stainless Steel 316 (EN 1.4401)

Part Number	Article Number	Strut Type	Rod Size RS
CSBRS2	404538	A (41 x 41 mm)	M10
CSBRS3	404539	A (41 x 41 mm)	M12
CSBRS4	402532	A (41 x 41 mm)	M16

## STRUT ROD STIFFENER

- Secures strut channel to threaded rod for stiffening

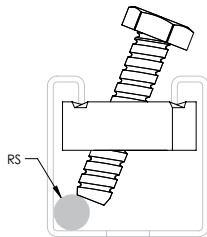

Material: Steel  
Finish: Electrogalvanized

Part Number	Article Number	Strut Type	Rod Size RS
CSBRS37EG	404467	A (41 x 41 mm)	M10, M12, M16, M20

## PIPE ROD STIFFENER

- For use with Schedule 40 or Schedule 10 pipe
- Secures pipe to threaded rod for stiffening

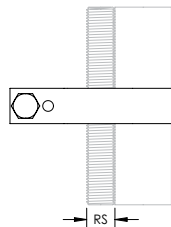

Material: Steel  
Finish: Electrogalvanized

Part Number	Article Number	Brace Pipe Size	Brace NB/DN	Rod Size RS
CSBRS1	402207	1"	25 mm	M10, M12, M16

# Branch Line Restraint System

## BRANCH LINE RESTRAINT PIPE ATTACHMENT

- Accepts M10 or M12 threaded rod
- Quick grip clamp simplifies measuring and cutting of threaded rod
- Eliminates need to cut threaded rod to exact dimensions
- Works with rough-cut threaded rod and eliminates pipe-side deburring
- Can be installed with threaded rod above or below the service pipe
- Shear-off head helps ensure correct torque and simplifies inspection

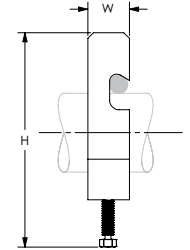
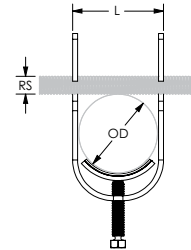

Material: Steel  
Finish: Electrogalvanized



Part Number	Article Number	Pipe Size	NB/DN	Outer Diameter	Rod Size	Height	Length	Width
CSBBRP0100EG	404477	1"	25	33.4 mm	M10, M12	169.4 mm	41.4 mm	22.2 mm
CSBBRP0125EG	404478	1 1/4"	32	42.2 mm	M10, M12	192.0 mm	50.0 mm	22.2 mm
CSBBRP0150EG	404479	1 1/2"	40	48.3 mm	M10, M12	208.4 mm	56.1 mm	22.2 mm
CSBBRP0200EG	404480	2"	50	60.3 mm	M10, M12	240.0 mm	68.3 mm	22.2 mm

## BRANCH LINE RESTRAINT STRUCTURE ATTACHMENT TO STEEL

- Swivel barrel nut accepts M10 or M12 threaded rod
- Attaches to steel members with self-drilling/tapping screw

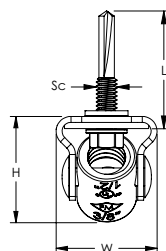
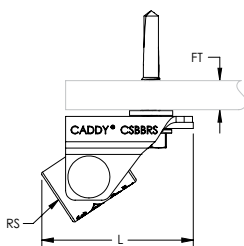

Material: Steel  
Finish: Electrogalvanized



Part Number	Article Number	Rod Size	Flange Thickness	Height	Length	Width	Screw Diameter	Screw Length
CSBBRS1MEG	402239	M10, M12	2.7 – 12.7 mm	28.2 mm	40.4 mm	26.9 mm	#12	32 mm

Branch line structural attachments are for restraint only and not for the hanging of fire sprinkler piping.



# Branch Line Restraint System

## BRANCH LINE RESTRAINT STRUCTURE ATTACHMENT TO WOOD/CONCRETE

- Swivel barrel nut accepts M10 or M12 threaded rod
- Attaches to steel members with self-drilling/tapping screw

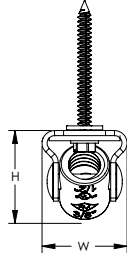
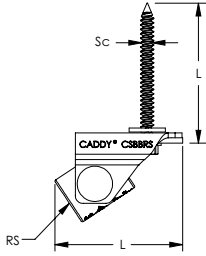

Material: Steel

Finish: Electrogalvanized



Part Number	Article Number	Rod Size	Height	Length	Width	Screw Diameter	Screw Length	Drill Bit Diameter
CSBBRS2MEG	402240	M10, M12	28.2 mm	40.4 mm	26.9 mm	1/4"	44.5 mm	5 mm

Branch line structural attachments are for restraint only and not for the hanging of fire sprinkler piping.  
Recommended drill bit is Powers Fasteners, Inc. part number 2785SD.

## BRANCH LINE RESTRAINT STRUCTURE ATTACHMENT TO THREADED HOLE

- Swivel barrel nut accepts M10 or M12 threaded rod
- Attaches to steel members with self-drilling/tapping screw

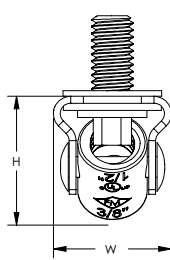
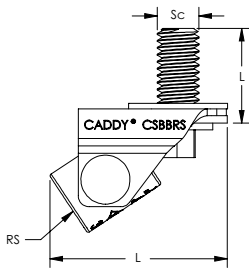

Material: Steel

Finish: Electrogalvanized

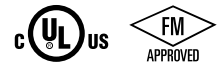

Part Number	Article Number	Rod Size	Height	Length	Width	Screw Diameter	Screw Length
CSBBRS3MEG	402241	M10, M12	28.2 mm	40.4 mm	26.9 mm	M10	19 mm

Branch line structural attachments are for restraint only and not for the hanging of fire sprinkler piping.

## DROP-IN ANCHOR

- Internal thread provides easy removal and serviceability
- Installs flush or below the base surface
- Fire resistance class R30-R120 for design of anchorages under exposure to fire
- Use setting tool TCA/LA to drive expansion cone to set the anchor



# Related Products

xxxx designated in the part numbers refers to parts with multiple sizes and/or finishes available.

## BSZ-SU CONCRETE SCREW

- Fire resistance class R30-R120 for design of anchorages under exposure to fire
- ETA assessed for anchoring in cracked and non-cracked concrete
- Approved for use in seismic design category C1 (for Drill Bit Diameters 8 mm and greater)
- Removable anchor is ideal for temporary fixings

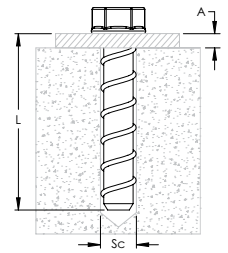

Material: Steel  
 Finish: Electrogalvanized  
 Certifications: CE, VdS



Part Number	Article Number	Drill Bit Diameter	Screw Length (L)	Embedment Depth	Fixture Thickness (A)	Screw Diameter (Sc)	Torque
BSZSU06040ZL	402605	6 mm	40 mm	35 mm	5 mm	7.4 mm	10 Nm
BSZSU06050ZL	402606	6 mm	50 mm	35 mm	10 mm	7.4 mm	10 Nm
BSZSU08070ZL	402610	8 mm	70 mm	65 mm	5 mm	10.6 mm	20 Nm
BSZSU10100ZL	402615	10 mm	100 mm	85 mm	15 mm	12.6 mm	30 Nm
BSZSU10120ZL	402620	10 mm	120 mm	85 mm	35 mm	12.6 mm	30 Nm
BSZSU12110ZL	402625	12 mm	110 mm	105 mm	5 mm	14.6 mm	50 Nm

The maximum load per fixing point for multiple use for non-structural applications may, depending on national regulations, be below the approved load of the anchor. The approved loads per fixing point are regulated for their respective countries in the ETAG 001, Part 6.

Total safety factor as per ETAG 001 included (Ym and Yf).  
 Service conditions can be checked via ETA.

## PIPE CLAMPS



2-Bolt Pipe Clamps  
 – Part No: DINxxxxx  
 – Part No: SSGxxxRO



nVent CADDY Macrofix Insulated M8/M10  
 – Part No: MFDxxxx



nVent CADDY Macrofix Plus Insulated  
 – Part No: MFPxxxx



nVent CADDY Macrofix Insulated Ventilation Duct Clamp  
 – Part No: MFVIxxxxEG

# Related Products

xxxx designated in the part numbers refers to parts with multiple sizes and/or finishes available.

## BOLT EXPANSION ANCHOR

- Heavy duty wedge anchor
- For cracked and non-cracked concrete
- Fire resistance class R30-R120 for design of anchorages under exposure to fire
- Approved for use in seismic design category C1 or C1/C2

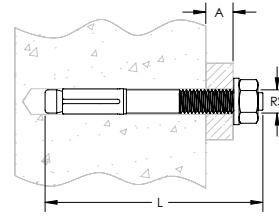

Part Number	Article Number	Drill Bit Diameter	Length (L)	Effective Anchorage Depth	Max Fixture Thickness (A)	Seismic Design Category	Rod Size (RS)	Torque
Material: Steel   Finish: Electrogalvanized								
SABM8010	400408	8 mm	75 mm	48 mm	9 mm	C1	M8	15 Nm
SABM8050	400409	8 mm	115 mm	48 mm	49 mm	C1	M8	15 Nm
SABM10010	400410	10 mm	90 mm	60 mm	10 mm	C1/C2	M10	40 Nm
SABM10050	400411	10 mm	135 mm	60 mm	55 mm	C1/C2	M10	40 Nm
SABM12015	402170	12 mm	110 mm	70 mm	14 mm	C1/C2	M12	60 Nm
SABM12050	401158	12 mm	150 mm	70 mm	54 mm	C1/C2	M12	60 Nm
SABM16025	402171	16 mm	145 mm	85 mm	28 mm	C1/C2	M16	100 Nm
SABM20030	402446	20 mm	170 mm	100 mm	1530 mm	C1/C2	M20	200 Nm
Material: Stainless Steel 316 (EN 1.4401)								
SABM8010S6	401150	8 mm	75 mm	48 mm	10 mm	C1/C2	M8	20 Nm
SABM8050S6	401151	8 mm	115 mm	48 mm	50 mm	C1/C2	M8	20 Nm
SABM10010S6	401152	10 mm	90 mm	60 mm	10 mm	C1/C2	M10	40 Nm
SABM10050S6	401153	10 mm	135 mm	60 mm	55 mm	C1/C2	M10	40 Nm

Total safety factor as per ETAG 001 included (Ym and Yf).  
Service conditions can be checked via ETA.

## STRUT CLAMPS



USC Universal Strut Clamp for Pipe/Conduit

– Part No: USCxxxx



C-EC Cable to Strut Clamp

– Part No: CxxEC



nVent CADDY Cushion Clamp Insulated Strut Clamp for Pipe/Tube

– Part No: CCCxxxx

# Related Products

xxxx designated in the part numbers refers to parts with multiple sizes and/or finishes available.

## RS RETROFIT RETAINER STRAP

- Ideal for both new and existing applications
- Can be installed without disassembly of the hanging system and/or removing the clamp
- Compatible with all standard nVent CADDY beam clamps and can be secured to either the set screw or threaded rod
- Large teardrop-shaped opening is compatible with multiple threaded rod diameters, reducing inventory by 50%
- Coined edge on teardrop-shaped opening locks into rod, eliminating shifting during install
- Provides a secure attachment in seismic zones and complies with NFPA® requirements

– Part No: RSxx



## TELESCOPING STRUT REPLACEMENT, NO NUT

- Can be attached directly to a wall for wall-mounted applications

– Part No: TSR1220N



## TELESCOPING STRUT REPLACEMENT, RETROFIT

- Slotted ends allow the bracket to be installed with four nVent CADDY SN Nuts on threaded rod above an existing trapeze, saving contractor time and limiting building downtime

– Part No: TSR1220R

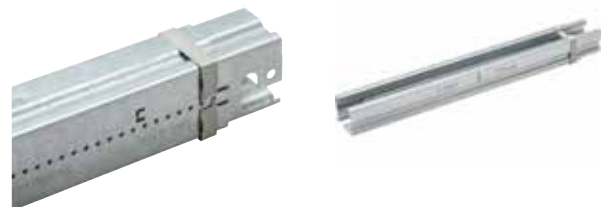

## SEISMIC LIGHTING FIXTURE CLAMP

- Secures fluorescent light fixtures to the ceiling frame members
- Requires no additional chains, cables or slack wires attached to the fixture
- Helps strengthen integrity of the T-Grid system
- Holds in place against the force of standard fire-hose pressure
- Meets U.S. building code and electrical code specifications
- Also satisfies NEC® 410.16(C) positive attachment for secure fastening of luminaires (fixtures) complying with Building Code Reference AC184

– Part No SFCLTCF



# Related Products

xxxx designated in the part numbers refers to parts with multiple sizes and/or finishes available.

## SNSW FLANGED NUT

- Ideal for retrofit projects, such as trapeze installations, where disassembly of the support system is not desired
- Use as a stopper when installing nVent CADDY Rod Lock assemblies
- Can be easily installed, removed, and repositioned at any location along the threaded rod
- Ready to use out of the box and eliminates multiple pieces of standard hardware
- Functions as a hex nut and flat washer combined
- Washer is wide enough to work with standard strut channel profiles

– Part No: **SNSWM8, SNSWM10**



## SN SERIES NUT

- Allows side mounting of nut to threaded rod
- Reduces the need for threading compared to standard nuts and washers
- Ideal for retrofit projects, such as trapeze installations, where disassembly of the support system is not desired
- Works with slightly damaged threads and minor burrs on the threaded rod
- Reduces installation time up to 50%

– Part No: **SNM6, SNM8, SNM10, SNM12**



## SIDE BEAM ATTACHMENTS

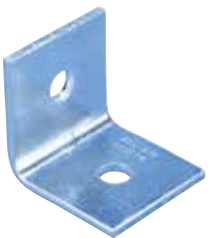

325 Steel  
Side Beam Attachment

– Part No: **325xxxx**



38 Offset Steel Eye Socket  
Rod Hanger

– Part No: **03800xxxx**



# Sway Brace Locations and Spacing

## Seismic Wire Rope / Cable Bracing

Break Strength Certified - Color Coded - Prestretched

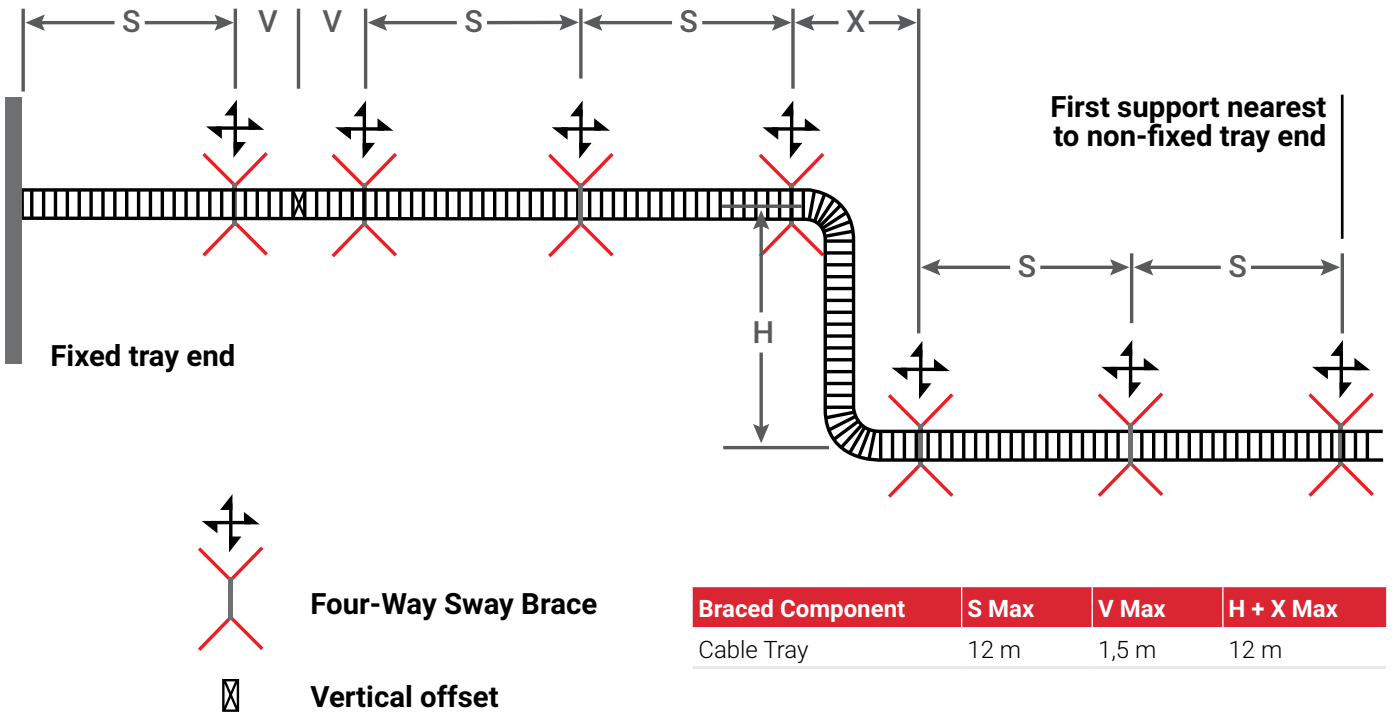

For horizontal offsets, a sway brace should be located at the cable tray support nearest to one end of the offset.

It is recommended that the max vertical offset without sway brace be 9 m and that the max spacing for sway braces on vertical trays should be 12 m.

Refer to specifications, nVent CADDY handbook and tables for brace spacing, required brace locations, procedures, sizing, and allowable loads on brace assemblies and fasteners.

Our powerful portfolio of brands:

**CADDY ERICO HOFFMAN RAYCHEM SCHROFF TRACER**



[nVent.com/CADDY](https://nVent.com/CADDY)