



**CONNECT AND PROTECT**

# Mechanical, Electrical and Plumbing Seismic Bracing Systems

  
nvent



**CADDY**

# Trapeze Bracing Attachments

xxxx designated in the part numbers refers to parts with multiple sizes and/or finishes available.

## RIGID BRACES STRUT BRACE MEMBER



Trapeze Sway Brace, Strut  
CSBR2 – p. 26



## RIGID BRACES PIPE / CONDUIT BRACE MEMBER



Trapeze Sway Brace, Pipe  
CSBR1 – p. 27



## CABLE BRACING



Cable Spool  
CSBxxCBLxx – p. 30

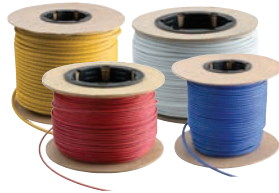

Universal Restraint Clip  
CSBURCxxxx – p. 32  
CSBURCRxx – p. 31

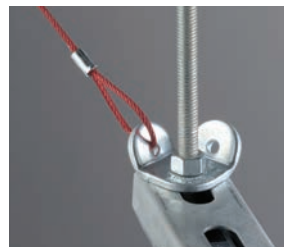

Ovsl Sleeve  
CSBxxSLVBxx – p. 30



URC Attachment Kit  
CSB2WxxURCxxLxx – p. 33



Cable Cutters  
– p. 31



Swaging Tools  
– p. 34

# Rod Stiffeners

## STRUT



nVent CADDY Quick Clip  
CSBRSx – p. 35



Strut Rod Stiffener  
CSBRS37EG – p. 35



## PIPE

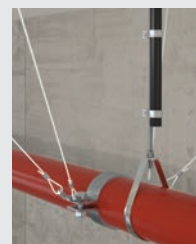

Pipe Rod Stiffener  
CSBRS1 – p. 35



# Single Pipe/Conduit Braces

xxxx designated in the part numbers refers to parts with multiple sizes and/or finishes available.

## RIGID BRACES PIPE / CONDUIT BRACE MEMBER



Universal Sway Brace  
[CSBxxxx](#) – p. 20



Quick Grip  
Lateral Sway Brace  
[CSBQGxxxxEG](#) – p. 24



Quick Grip Jr.  
Lateral Sway Brace  
[CSBQIKLxxxxEG](#) – p. 22



Lateral Telescoping  
Brace Assembly  
[CSBTx](#) – p. 19



## CABLE BRACING



Cable Spool  
[CSBxxCBLxx](#) – p. 30

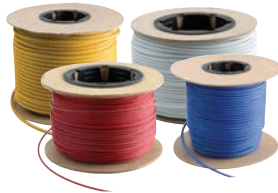

Oval Sleeve  
[CSBxxSLVBxx](#)  
– p. 30



Cable Cutters  
– p. 31



Swaging Tools  
– p. 34



# Accessories

## REPLACEMENT HARDWARE

Cone Point Shear Bolt  
– p. 29

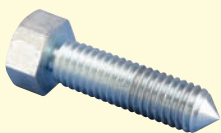

Rivet Head Shear Bolt  
– p. 29

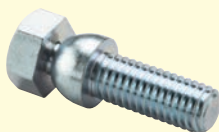

Shear Nut  
– p. 29



## SWAY BRACING

Clevis Bolt Spacer  
[CSBCSxxxx](#) – p. 28



# Structural Attachments – Steel

xxxx designated in the part numbers refers to parts with multiple sizes and/or finishes available.

## FLANGE ADAPTERS



Steel Flange Adapter  
CSBSx – p. 12



Adjustable I-Beam  
Adapter  
CSBSx – p. 14



## FLANGE ADAPTER ASSEMBLY – PIPE / CONDUIT BRACE



Steel Flange Adapter Assembly  
CSBS1A – p. 13



## THROUGH BOLT ATTACHMENT – PIPE / CONDUIT BRACE



Universal Structural  
Bracket  
CSBUX – p. 18



## THROUGH BOLT ATTACHMENT – STRUT BRACE



Universal Structural  
Bracket, Strut Brace  
CSBUSx – p. 17



Strut Seismic Hinge  
Bracket Assembly  
CSBUSXPA – p. 16



## CABLE BRACING



Universal Restraint Clip  
CSBURCxxxx – p. 32



No Pry Clip  
CSBNPCxx – p. 31

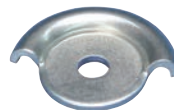

URC Attachment Kit  
CSB2WxxURCxxLxx – p. 33



# nVent CADDY Pyramid Rooftop Anchor System

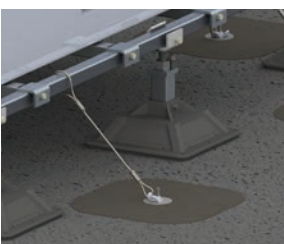

Rooftop Anchor  
CRAU24xxxx – p. 37



Rooftop Anchor Cable Bracing  
CRA36SS38Lx – p. 38



Deck Screw  
A927WxxxP100 – p. 38



# Structural Attachments – Concrete / Wood

xxxx designated in the part numbers refers to parts with multiple sizes and/or finishes available.

## FOR STRUT BRACE MEMBER

Universal Structural Bracket, Strut Brace  
CSBUSx – p. 17



Strut Seismic Hinge Bracket Assembly  
CSBUSxPA – p. 16



## FOR PIPE / CONDUIT BRACE MEMBER

Universal Structural Bracket  
CSBUx – p. 18



## FOR CABLE BRACING

Universal Restraint Clip  
CSBURCxxxx – p. 32



No Pry Clip  
CSBNPCxx – p. 31

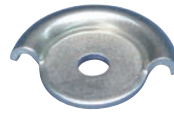

URC Attachment Kit  
CSB2WxxURCxxLxx – p. 33



## LOAD DOUBLER

Multi Attachment  
CSBMAXxxxxEG – p. 15



## Related Products

Seismic Lighting Fixture Clamp  
– p. 39



RS Retrofit Retainer Strap  
– p. 39



Telescoping Strut Replacement  
– p. 40



SN Series Nut / SNSW Flanged Nut for Strut  
– p. 40



401 Clevis Hanger  
– p. 42



Telescoping Pipe Stand  
– p. 41



HangerMate® Horizontal Mount Screw for Steel with Lock Nut  
– p. 41



Pipe Clamps  
– p. 42



Strut Clamps  
– p. 42



Side Beam Attachments  
– p. 42



# nVent CADDY Seismic Bracing Systems Overview

nVent CADDY Seismic Solutions protect people, property and equipment during and after a seismic event by ensuring business continuity and continued operation of critical infrastructure and services. Areas of nVent CADDY expertise:

- Designing a complete, right-sized bracing system
- Identifying the appropriate product from our broad offering
- Offering compatible attachment and support products
- Explaining installation techniques and tips to meet evolving codes and standards requirements

From design to construction to inspection, the nVent CADDY team makes seismic simple by walking you through the full process for applications including Mechanical, HVAC, Electrical, Plumbing and Fire Protection.

Both cable and rigid bracing solutions are available for single pipe or conduit, trapeze, and for floor-, roof-, and wall-mounted equipment.

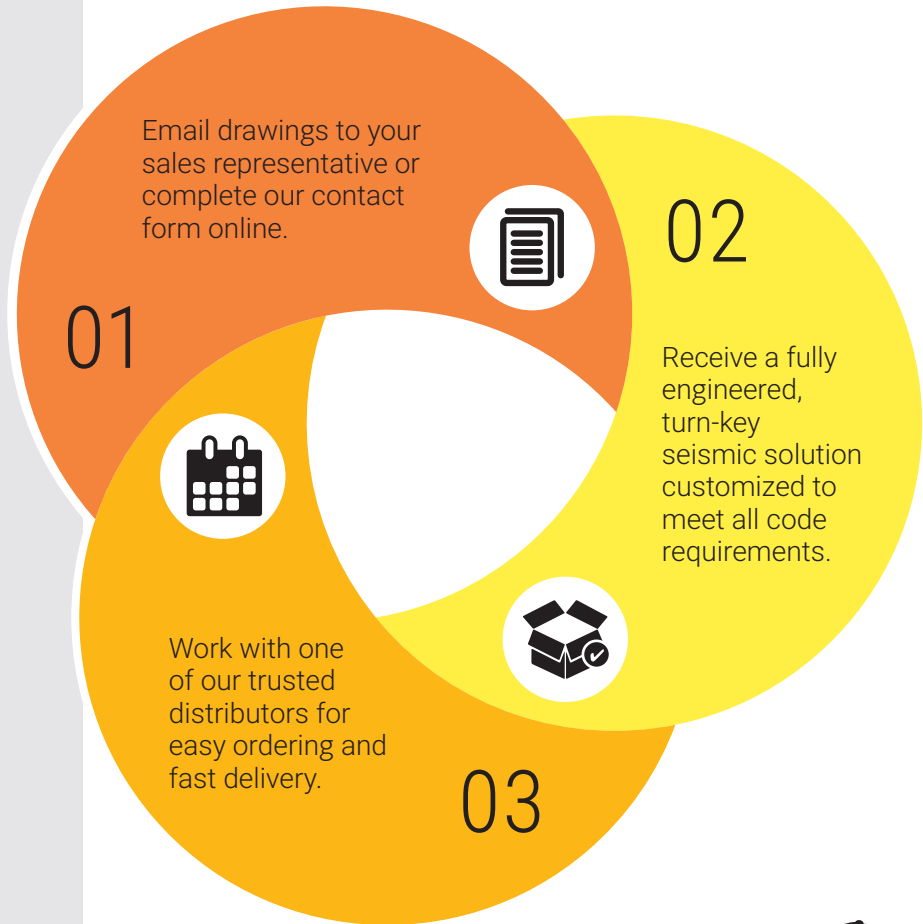

WE MAKE  
SEISMIC  
SIMPLE

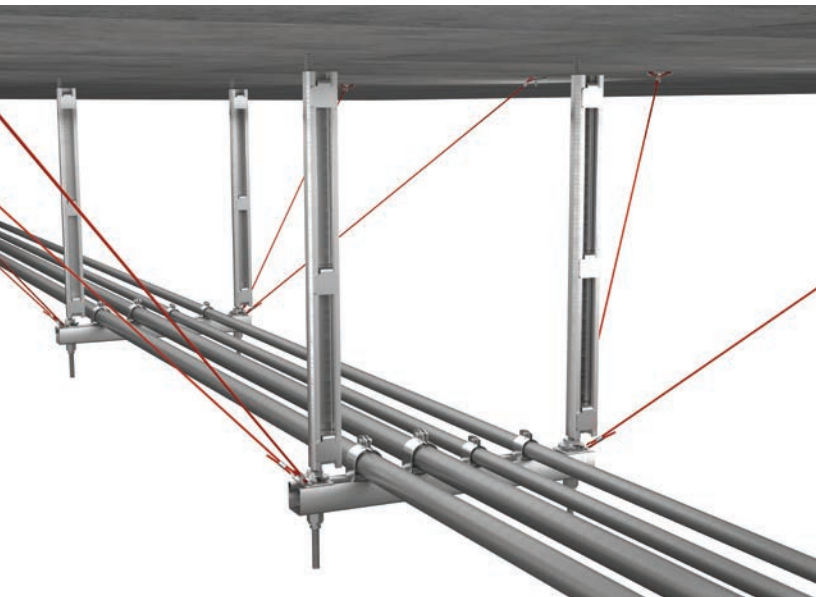
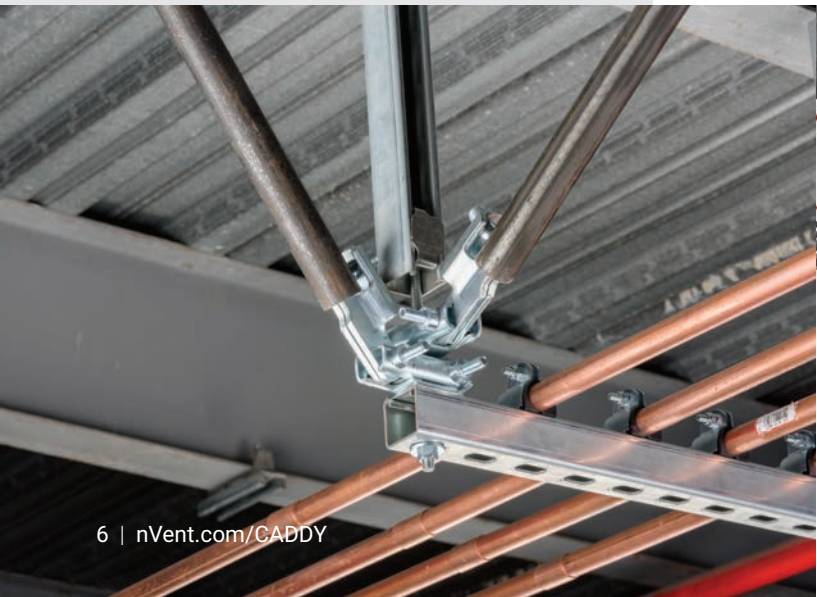
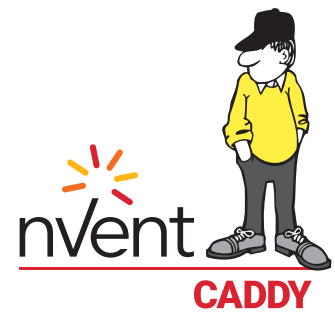

## ENGINEERING SOLUTIONS

- Design optimization to meet your needs
- Bracing layouts with bill of material using code compliant products
- Stamped drawings

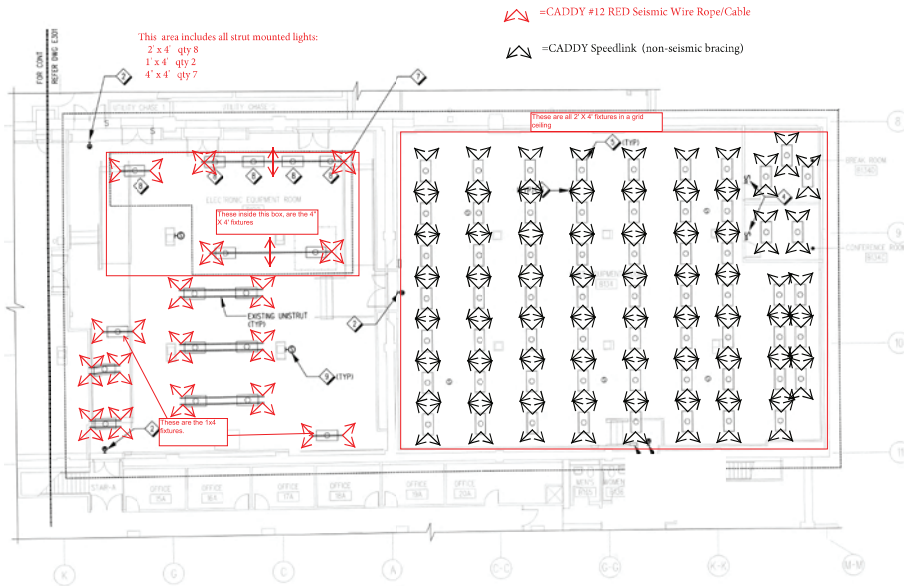

## CUSTOMER EXPERIENCE

- Quick turnaround
- Local availability through distributors
- In-market support from the local nVent CADDY sales team

"nVent's seismic experts provide everything we need for a code compliant cable bracing system. Their patented, turn-key seismic solutions give us peace of mind that our building products are properly braced for a seismic event."

**Tim Barmeier**  
Mechanical Supply Company

## PRODUCT SOLUTIONS

- Cable and rigid bracing solutions
- Innovative products
- Superior full range of bracing solutions



# nVent CADDY Seismic Bracing Systems Overview

## DETERMINING FACTORS IN BRACING

The requirements for seismic protection depend on the building risk category or risk classification as well as the building location. The higher the seismicity of the location and greater the building occupancy, the more stringent the requirements. For example, military or healthcare facilities in a generally seismically-moderate area will typically require some bracing because of the buildings importance to disaster recovery, when an adjacent strip mall may not require it.

### Risk Category

**Category I:** Low hazard to human life, barns

**Category II:** Residential, strip malls, individual commercial buildings

**Category III:** High occupancy, stadiums, buildings containing hazardous materials

**Category IV:** Hospitals and essential facilities, government buildings

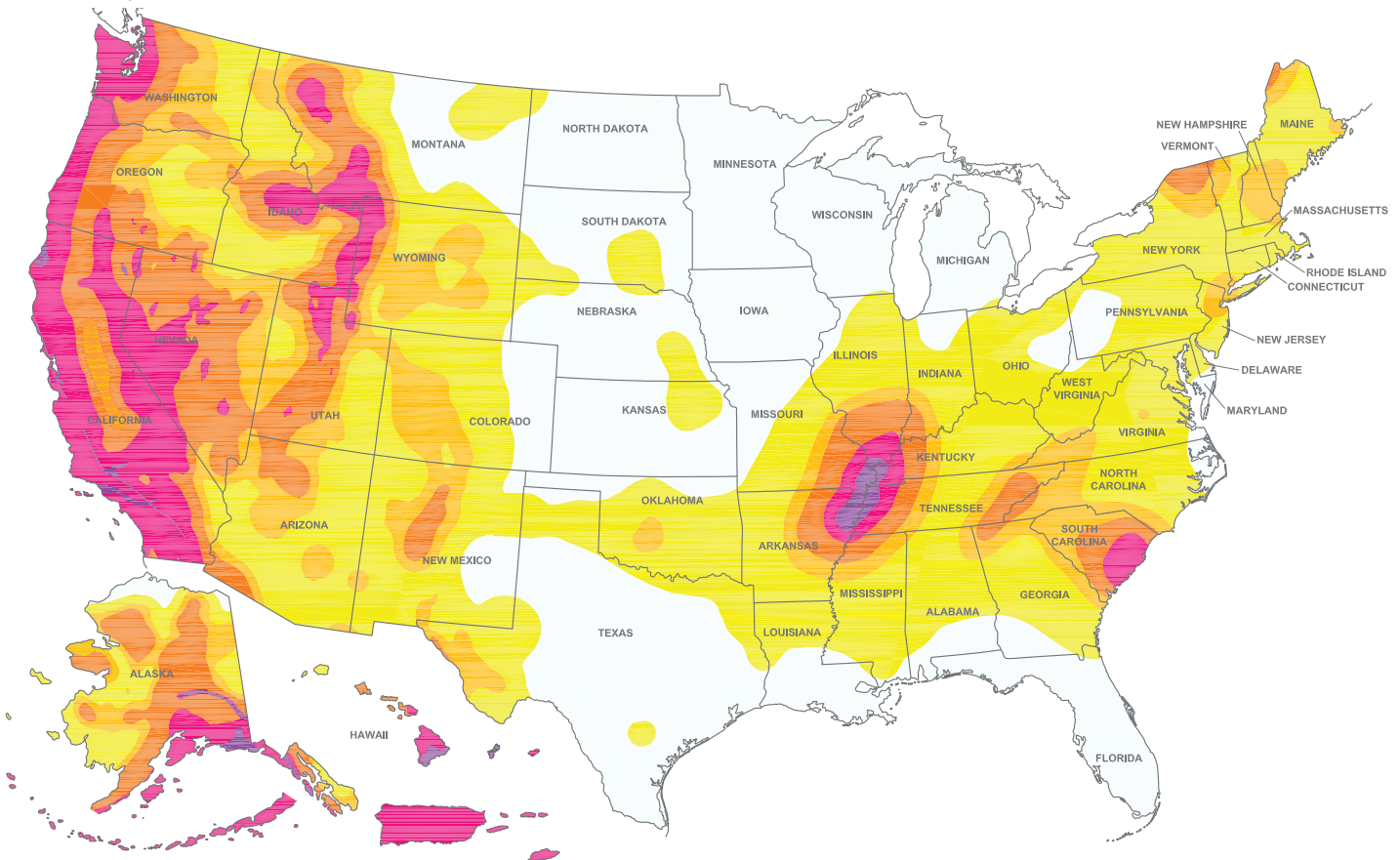



## WHAT NEEDS TO BE BRACED

- Hospitals
- Airports
- Power Plants
- Schools
- Casinos
- Shelters
- Resorts
- Stadium
- Arenas
- Prisons
- Dams
- Water treatment
- Pharmaceutical
- Police stations
- Public utilities
- Government buildings

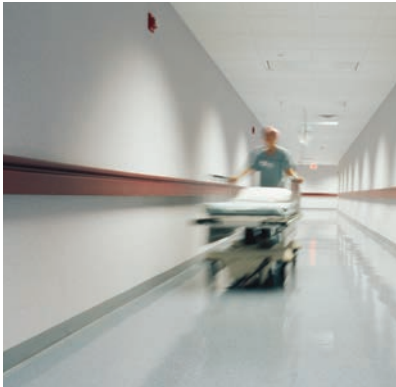

## COMMON COMPONENTS THAT REQUIRE SEISMIC BRACING

Suspended mechanical, electrical, plumbing components:

- Piping systems
- HVAC ductwork
- Conduits
- Bus ducts
- Cable trays
- Suspended equipment

Floor mounted, roof mounted and wall mounted:

- Panel boards
- Switchgears
- Generators
- Air conditioners
- Chillers
- Cooling towers
- Transformers
- Air handling units
- Pumps

Process equipment

Equipment with hazardous materials

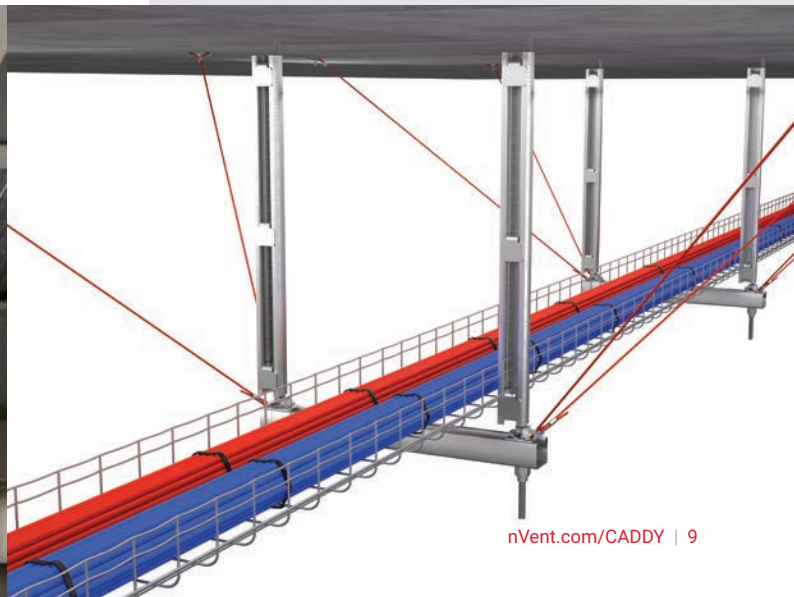

# nVent CADDY Seismic Bracing Systems Overview

## THE NEED FOR BRACING

### Legal and Building Requirements

The need for earthquake protection of nonstructural building components is found in the structural design requirements of the building code and in the building code reference standard ASCE 7 (American Society of Civil Engineers). These nonstructural building components are: architectural, mechanical, electrical, and plumbing equipment and systems. Chapter 13 of ASCE 7 contains the seismic design requirements.

The Earthquake Hazard Reduction Act (Public Law 95-124) of 1977 was amended in 1990 (Public Law 101-614) to formulate policy diminishing the perils of earthquakes in the United States. This policy established the National Earthquake Hazard Reduction Program (NEHRP).

Executive Order (EO) 13717 was enacted in 2016 ("Establishing a Federal Earthquake Risk Management Standard"), and mandates the implementation of the NEHRP standards for reducing earthquake vulnerabilities of facilities and systems.

EO 13717 orders that every new building covered by the order and for which project assumptions, scope, budgets and strategy for building start after May 2, 2016 shall comply with the seismic provisions of the 2015 or later edition of the International Building Code (IBC).

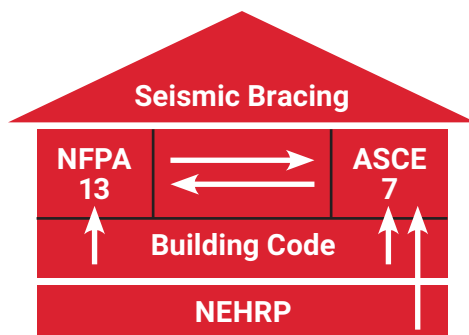

Guidelines and specifications direct the implementation of seismic bracing

Reference standards

Legally adopted building code requirements

Laws



# Table of Contents

## People, Property and Operation Continuity Protection

Earthquakes can lead to business disruption, causing damage to mechanical, HVAC, electrical, plumbing and fire protection systems or equipment. Differential movement of building systems during an earthquake may cause them to break, fall, or collide and damage other adjacent systems, damage assets and inventory, or injure people.

### Rigid Bracing ..... p. 12

Structural Attachments.....	12
Lateral Telescoping Brace Assembly .....	19
Sway Braces .....	20
Replacement Nuts and Bolts .....	29

### Cable Bracing ..... p. 30

Cable Spool.....	30
Oval Sleeve.....	30
Restraint Clips .....	31, 32
Attachment Kits .....	33
Cable Cutters and Swaging Tools .....	31, 34

### Rod Stiffeners ..... p. 35

nVent CADDY Quick Clip Rod Stiffener.....	35
Strut Rod Stiffener.....	35
Pipe Rod Stiffener .....	35

### nVent CADDY Pyramid Rooftop Anchor System..... p. 36

nVent CADDY Pyramid Rooftop Anchor .....	37
nVent CADDY Pyramid Rooftop Anchor Cable Bracing .....	38
Deck Screw .....	38

### Related Products ..... p. 39

Additional nVent CADDY products frequently used when installing mechanical, electrical, or plumbing applications



nVent CADDY Pyramid Rooftop Anchor System  
See page 36

# Rigid Bracing – Structural Attachments

## STEEL FLANGE ADAPTER

- Meets requirements of the Buy American Act
- Installs on top or bottom flange of I-beams and top of bar joist (horizontal and vertical leg)
- Low profile easily fits between metal deck and steel structure
- Thumb spring retainer allows for ease of positioning
- Available pre-assembled to the Universal Structural Bracket, eliminating field assembly
- Snap-off bolt head helps enable easy installation and inspection of seismic sway braces
- Meets NFPA® 13 as pre-qualified for seismic applications

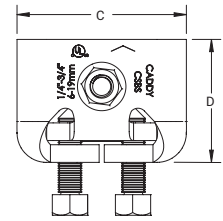
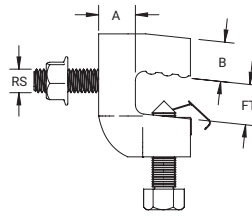

Material: Steel  
Finish: Electrogalvanized



Part Number	Flange Thickness FT	Rod Size RS	A	B	C	D
CSBS1	1/4" – 3/4"	1/2"	13/16"	7/8"	3 5/8"	2 5/8"
CSBS2	3/4" – 1 1/4"	1/2"	7/8"	7/8"	3 5/8"	3 1/8"

UL Loads			
Assembly Part Numbers	Flange Thickness	Load Rating	Bracing Member
CSBS1 with CSBU1	1/4" – 5/16"	1500 lb	1" to 2" Schedule 40
CSBS1 with CSBU1	3/8" – 3/4"	1885 lb	1" to 2" Schedule 40
CSBS1 with CSBURC12	1/4" – 3/4"	1100 lb	#12 Red 3/32", #18 White 1/8" or #36 Blue 3/16" Wire Rope Cable Bracing
CSBS2 with CSBU1	3/4" – 1 1/4"	1704 lb	1" to 2" Schedule 40
CSBS2 with CSBURC12	3/4" – 1 1/4"	1100 lb	#12 Red 3/32", #18 White 1/8" or #36 Blue 3/16" Wire Rope Cable Bracing

Parts sold separately

FM Loads								
Part Number	Horizontal Capacity per Installation Angle from Vertical							
	Perpendicular to Structure				Parallel to Structure			
	30° – 44°	45° – 59°	60° – 74°	75° – 90°	30° – 44°	45° – 59°	60° – 74°	75° – 90°
CSBS1	850 lb	1,780 lb	2,770 lb	2,840 lb	880 lb	1,430 lb	2,020 lb	2,410 lb
CSBS2	1,220 lb	2,140 lb	2,580 lb	2,870 lb	1,100 lb	1,820 lb	2,190 lb	2,680 lb

# Rigid Bracing – Structural Attachments

## STEEL FLANGE ADAPTER ASSEMBLY

- Meets requirements of the Buy American Act
- Steel Flange Adapter and Universal Structural Bracket are preassembled, limiting work required in the field
- Installs on top or bottom flange of I-beams and top of bar joist (horizontal and vertical leg)
- Low profile easily fits between metal deck and steel structure
- Thumb spring retainer allows for ease of positioning
- Integrated angle gauge easily displays brace member angle of installation
- Snap-off bolt head helps enable easy installation and inspection of seismic sway braces
- Works with 1" through 2" brace pipes to reduce inventory
- Meets NFPA® 13 as pre-qualified for seismic applications

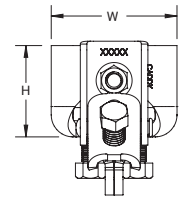
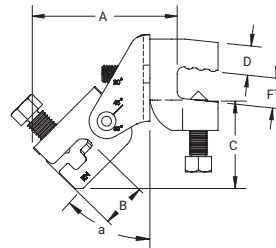
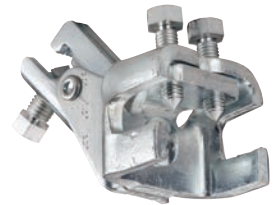

Note: This part is used in conjunction with Sway Brace CSBR1 – See p. 27

Material: Steel  
Finish: Electrogalvanized



Part Number	Flange Thickness FT	Height H	Width W	Angle a	A	B	C	D
CSBS1A	1/4" – 3/4"	2 5/8"	3 5/8"	45°	4 1/8"	1 5/16"	2 9/16"	7/8"

UL Loads			
Assembly Part Numbers	Flange Thickness	Load Rating	Bracing Member
CSBS1A	1/4" – 5/16"	1500 lb	1" to 2" Schedule 40
CSBS1A	3/8" – 3/4"	1885 lb	1" to 2" Schedule 40

Part sold as Assembly

FM Loads								
Part Number	Horizontal Capacity per Installation Angle from Vertical							
	Perpendicular to Structure				Parallel to Structure			
	30° – 44°	45° – 59°	60° – 74°	75° – 90°	30° – 44°	45° – 59°	60° – 74°	75° – 90°
CSBS1A	850 lb	1,780 lb	2,770 lb	2,840 lb	880 lb	1,430 lb	2,020 lb	2,410 lb

# Rigid Bracing – Structural Attachments

## ADJUSTABLE I-BEAM ADAPTER

- Meets requirements of the Buy American Act
- No loose parts
- No assembly required
- Installs to the bottom of I-beams when attachment to both sides is required
- Snap-off bolt head helps enable easy installation and inspection of seismic sway braces
- Meets NFPA®-13 requirements for seismic sway bracing

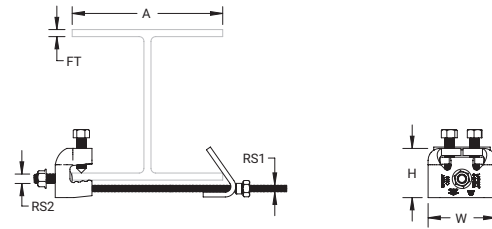

Material: Steel  
Finish: ElectroGalvanized



Part Number	Flange Thickness FT	A	Rod Size 1 RS1	Rod Size 2 RS2	Height H	Width W
CSBS3	1/4" – 3/4"	4" – 8 1/2"	3/8"	1/2"	2 5/8"	3 5/8"
CSBS4	1/4" – 3/4"	4" – 14 1/2"	3/8"	1/2"	2 5/8"	3 5/8"
CSBS5	3/4" – 1 1/4"	4" – 18"	3/8"	1/2"	3 1/8"	3 5/8"

UL Loads			
Part Number	Flange Thickness	Perpendicular to Structure	Parallel to Structure
CSBS3 with CSBU1	1/4" – 5/16"	1500 lb	1" to 2" Schedule 40
CSBS3 with CSBU1	3/8" – 3/4"	1885 lb	1" to 2" Schedule 40
CSBS3 with CSBURC12	1/4" – 3/4"	1100 lb	#12 Red 3/32", #18 White 1/8" or #36 Blue 3/16" Wire Rope Cable Bracing
CSBS4 with CSBU1	1/4" – 5/16"	1500 lb	1" to 2" Schedule 40
CSBS4 with CSBU1	3/8" – 3/4"	1885 lb	1" to 2" Schedule 40
CSBS4 with CSBURC12	1/4" – 3/4"	1100 lb	#12 Red 3/32", #18 White 1/8" or #36 Blue 3/16" Wire Rope Cable Bracing
CSBS5 with CSBU1	3/4" – 1 1/4"	1704 lb	1" to 2" Schedule 40
CSBS5 with CSBURC12	3/4" – 1 1/4"	1100 lb	#12 Red 3/32", #18 White 1/8" or #36 Blue 3/16" Wire Rope Cable Bracing

Parts sold separately

FM Loads								
Part Number	Horizontal Capacity per Installation Angle from Vertical							
	Perpendicular to Structure				Parallel to Structure			
	30° – 44°	45° – 59°	60° – 74°	75° – 90°	30° – 44°	45° – 59°	60° – 74°	75° – 90°
CSBS3	1,180 lb	2,210 lb	2,830 lb	2,940 lb	820 lb	1,380 lb	2,080 lb	3,010 lb
CSBS4	1,180 lb	2,210 lb	2,830 lb	2,940 lb	820 lb	1,380 lb	2,080 lb	3,010 lb
CSBS5	1,220 lb	2,140 lb	2,580 lb	2,870 lb	1,100 lb	1,820 lb	2,190 lb	2,680 lb

# Rigid Bracing – Structural Attachments

## MULTI ATTACHMENT

- Disperses load over two anchors
- Minimizes the number of installed braces needed for concrete and wood structures
- Ideal for deck installations
- Use for both lateral and longitudinal sway brace applications
- Meets NFPA®-13 requirements for seismic sway bracing

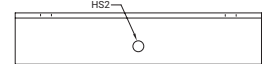

Material: Steel  
Finish: Electrogalvanized



Part Number	Hole Size 1 HS1	Hole Size 2 HS2	A	B	C	D
CSBMA050050EG	9/16"	9/16"	12"	2 1/2"	2 1/2"	9"
CSBMA050075EG	13/16"	9/16"	12"	2 1/2"	2 1/2"	9"

Mount to structure using holes indicated in HS1.

UL Loads		
Assembly Part Numbers	Load Rating	Bracing Member
CSBMA050050EG with CSBU1	680 lb	1" to 2" Schedule 40
CSBMA050050EG with CSBURC12	1100 lb	1" to 2" Schedule 40
CSBMA050050EG with CSBNPC12	1300 lb	#12 Red 3/32", #18 White 1/8" or #36 Blue 3/16" Wire Rope Cable Bracing
CSBMA050075EG with CSBU1	680 lb	1" to 2" Schedule 40
CSBMA050075EG with CSBURC12	1100 lb	1" to 2" Schedule 40
CSBMA050075EG with CSBNPC12	1300 lb	#12 Red 3/32", #18 White 1/8" or #36 Blue 3/16" Wire Rope Cable Bracing

FM Loads				
Part Number	Horizontal Capacity per Installation Angle from Vertical			
	30° – 44°	45° – 59°	60° – 74°	75° – 90°
CSBMA050050EG	3,290 lb	4,520 lb	5,540 lb	6,200 lb
CSBMA050075EG	3,290 lb	4,520 lb	5,540 lb	6,200 lb

# Rigid Bracing – Structural Attachments

## STRUT SEISMIC HINGE BRACKET ASSEMBLY

- Used for installations where strut brace is parallel to structure
- One wrench size fits all required hardware, eliminating the need to change tools
- Shear-off head helps ensure correct torque and simplifies inspection
- Compatible with brace members of 12 GA strut type A



Note: This part is used in conjunction with Sway Brace CSBR2 – See p. 26

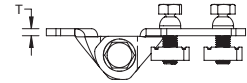
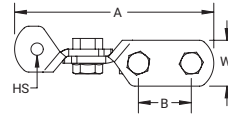

Material: Steel  
Finish: Electrogalvanized



Part Number	Hole Size 1	Width W	Thickness T	A	B
CSBUS1PA	9/16"	1.6"	1/4"	7"	1.88"
CSBUS2PA	13/16"	1.6"	1/4"	7"	1.88"

FM Loads					
Part Number	Brace Member	Horizontal Capacity per Installation Angle from Vertical			
		30° – 44°	45° – 59°	60° – 74°	75° – 90°
CSBUS1PA	12 GA Strut Channel	1,162 lb	1,864 lb	1,864 lb	1,680 lb
CSBUS2PA	12 GA Strut Channel	1,162 lb	1,864 lb	1,864 lb	1,680 lb



# Rigid Bracing – Structural Attachments

## UNIVERSAL STRUCTURAL BRACKET, STRUT BRACE

- Used for installations where strut brace is perpendicular to structure
- One wrench size fits all required hardware, eliminating the need to change tools
- Shear-off head helps ensure correct torque and simplifies inspection
- Compatible with brace members of 12 GA strut type A

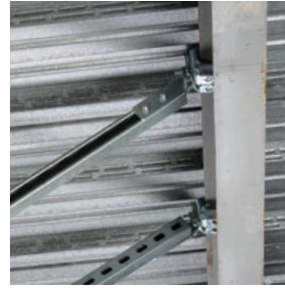

Note: This part is used in conjunction with Sway Brace CSBR2 – See p. 26

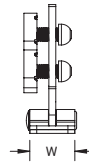
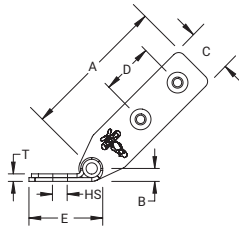

Material: Steel  
Finish: Electrogalvanized



Part Number	Hole Size HS	Width W	Thickness T	A	B	C	D	E
CSBUS1	9/16"	1.6"	1/4"	5 1/4"	1/2"	1.6"	2"	2.6"
CSBUS2	13/16"	1.6"	1/4"	5 1/4"	1/2"	1.6"	2"	2.6"

Cut length for strut member is +/- 1" (25 mm) of measured length.

FM Loads					
Part Number	Brace Member	Horizontal Capacity per Installation Angle from Vertical			
		30° – 44°	45° – 59°	60° – 74°	75° – 90°
CSBUS1	12 GA Strut Channel	2,010 lb	2,840 lb	3,420 lb	3,810 lb
CSBUS2	12 GA Strut Channel	2,010 lb	2,840 lb	3,420 lb	3,810 lb

# Rigid Bracing – Structural Attachments

## UNIVERSAL STRUCTURAL BRACKET

- Meets requirements of the Buy American Act
- Universal design allows one product to attach directly to concrete, wood, bar joist or I-beam adapters
- Integrated angle gauge easily displays brace member angle of installation
- Snap-off bolt head helps enable easy installation and inspection of seismic sway braces
- Works with 1" through 2" brace pipes to reduce inventory
- Low profile minimizes prying effect on concrete fasteners decreasing the number of braces used
- Meets NFPA® 13 as pre-qualified for seismic applications



Note: This part is used in conjunction with Sway Brace CSBR1 – See p. 27

Horizontal / Ceiling Angles

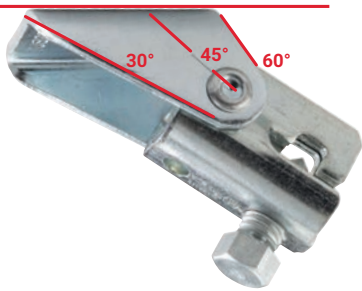

Vertical / Wall Angles

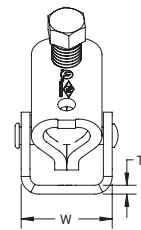
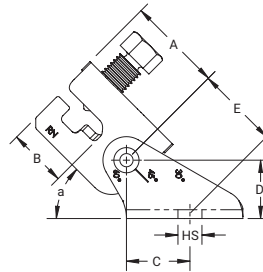
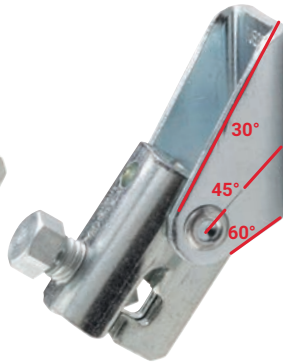

Material: Steel  
Finish: Electrogalvanized



Part Number	Hole Size HS	Width W	Thickness T	A	B	C	D	E	UL Listed Load Rating
CSBU1	1/2"	1 15/16"	3/16"	2 1/16"	1 5/16"	1 3/8"	1 1/4"	1 3/4"	2045 lb
CSBU2	13/16"	1 15/16"	3/16"	2 1/16"	1 5/16"	1 3/8"	1 1/4"	1 3/4"	2045 lb

FM Loads				
Part Number	Horizontal Capacity per Installation Angle from Vertical			
	30° – 44°	45° – 59°	60° – 74°	75° – 90°
CSBU1	1,690 lb	2,210 lb	2,660 lb	3,090 lb
CSBU2	1,480 lb	2,290 lb	2,860 lb	3,090 lb

# Rigid Bracing

## LATERAL TELESCOPING BRACE ASSEMBLY

- Complete, out of the box assembly is compatible with both steel (IPS) and CPVC piping
- Telescoping brace member eliminates the need to cut pipe, minimizing waste and allowing one person to effectively complete the installation
- Easy “push-to-install” nVent CADDY Rod Lock feature allows the V-bolt to assemble quickly, and helps eliminate the risk of compressing CPVC pipe
- Length of telescoping lateral brace is fixed by installing the included self-drilling screw
- Electrogalvanized coating throughout the entire assembly provides superior corrosion resistance, and eliminates the risk of exposing CPVC pipe to any harmful oils or residue
- Designed to reduce the installation time of a complete brace by up to 80%
- Design allows center loading of brace on the service pipe
- Meets requirements of NFPA® 13
- FM® Specification Tested

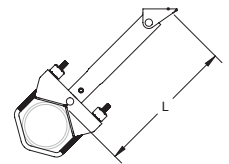
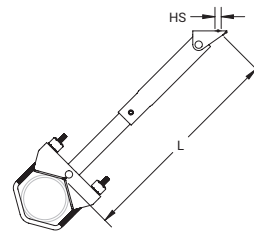

Material: Steel

Finish: Electrogalvanized



Part Number	Brace Length L	Pipe Size	Hole Size HS	Wrench Size	UL Listed Load
CSBT1	1' – 1 1/2'	1" – 4"	1/2"	5/16"	680 lb
CSBT2	1 1/2' – 3'	1" – 4"	1/2"	5/16"	680 lb

UL Listed Load applies to Sch 40, Sch 10, Youngstown Tube Fire-Flo (1-1/2" to 4"), Bull Moose Eddy Flo (1-1/4" to 4"), and Wheatland Mega Flow (1-1/4" to 4") service pipes.

Wrench Size represents the hex size used to tighten the self-drilling screw.

### Vertical Distance from Structure to Pipe Centerline Based on 45° Brace Angle

Part Number	Pipe Size			
	1"	2"	3"	4"
CSBT1	10" – 13"	10" – 13"	11" – 14"	11" – 14"
CSBT2	12" – 22"	12" – 23"	13" – 23"	13" – 24"
CSBT3	23" – 40"	24" – 41"	24" – 42"	25" – 42"
CSBT4	41" – 51"	42" – 52"	43" – 52"	43" – 53"

Part Number	Run Pipe Nom. Size	Run Pipe Reference	Horizontal Capacity per Installation Angle from Vertical			
			30° – 44°	45° – 59°	60° – 74°	75° – 90°
<b>Loads According to FM 1950-2013</b>						
CSBTx	1" – 4"	LW, Sch. 10, Sch. 40	630 lb	1,050 lb	1,050 lb	1,190 lb
<b>Loads According to ANSI/FM 1950-2016</b>						
CSBTx	1" – 4"	LW, Sch. 10, Sch. 40	475 lb	790 lb	790 lb	890 lb

Load rating for LW above refers to FM Approved Lightweight pipe, commonly referred to Sch. 7. These ratings may also be applied to EN 10220 and GB/T 8163 pipe.

Load rating for Sch. 10 above may be applied to GB/T 3091, GB/T 3092, EN 10255M and H, JIS G3452, FM Approved Thinwall pipe and Sch. 40.

Load rating for Sch. 40 may be applied to Sch. 80.

# Rigid Bracing – Sway Braces

## UNIVERSAL SWAY BRACE

- Meets requirements of the Buy American Act
- Use for both lateral and longitudinal sway brace applications
- Unique slotted holes provide for easy slip-on installation eliminating loose hardware
- Snap-off bolt head helps enable easy installation and inspection of seismic sway braces
- Works with 1" through 2" brace pipes to reduce inventory
- Meets NFPA®-13 requirements for seismic sway bracing

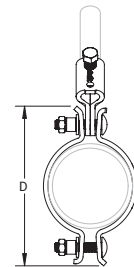
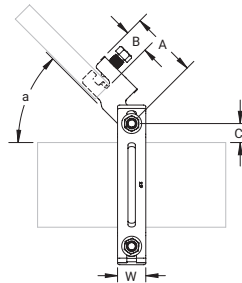

Material: Steel  
Finish: Electrogalvanized



Part Number	Pipe Size	Brace Pipe Size	Width W	Angle a	A	B	C	D
CSB0100	1"	1" – 2"	1 1/2"	45°	3 9/16"	1 5/16"	5/8"	5"
CSB0125	1 1/4"	1" – 2"	1 1/2"	45°	3 9/16"	1 5/16"	11/16"	5 1/2"
CSB0150	1 1/2"	1" – 2"	1 1/2"	45°	3 9/16"	1 5/16"	3/4"	5 3/8"
CSB0200	2"	1" – 2"	1 1/2"	45°	3 9/16"	1 5/16"	13/16"	6"
CSB0250	2 1/2"	1" – 2"	1 1/2"	45°	3 9/16"	1 5/16"	15/16"	6 3/4"
CSB0300	3"	1" – 2"	1 1/2"	45°	3 9/16"	1 5/16"	1"	7 3/8"
CSB0400	4"	1" – 2"	1 1/2"	45°	3 9/16"	1 5/16"	1 1/16"	8 1/2"
CSB0500	5"	1" – 2"	1 1/2"	45°	3 9/16"	1 5/16"	1"	10 1/16"
CSB0600	6"	1" – 2"	1 1/2"	45°	3 9/16"	1 5/16"	1 1/8"	10 7/8"
CSB0800	8"	1" – 2"	1 1/2"	45°	3 9/16"	1 5/16"	1 1/4"	13"
CSB1000	10"	1" – 2"	1 1/2"	45°	3 9/16"	1 5/16"	1"	15 3/16"

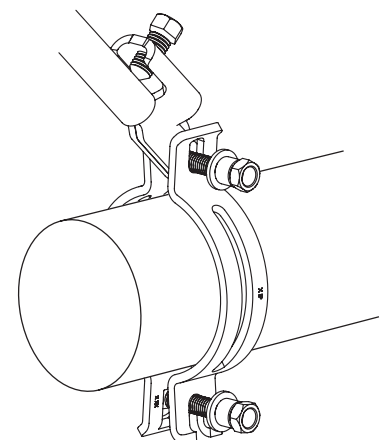
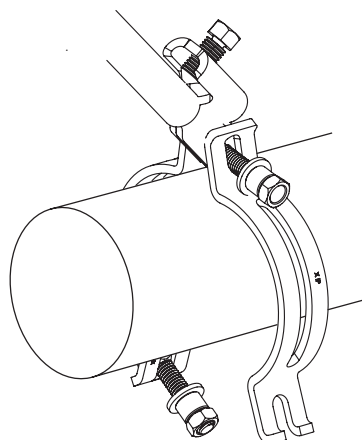

# Rigid Bracing – Sway Braces

UL Loads									
Part Number	Lateral				Part Number	Longitudinal			
	Sch 10/Sch 40 Service Pipe	Bull Moose Eddy Flow Service Pipe	Wheatland Mega Flow Service Pipe	Youngstown Tube Fire Flow Service Pipe		Sch 10/Sch 40 Service Pipe	Bull Moose Eddy Flow Service Pipe	Wheatland Mega Flow Service Pipe	Youngstown Tube Fire Flow Service Pipe
CSB0100	1885 lb	–	–	–	CSB0100	1090 lb	–	–	–
CSB0125	1885 lb	1885 lb	1885 lb	–	CSB0125	680 lb	680 lb	680 lb	–
CSB0150	1885 lb	1885 lb	1885 lb	1885 lb	CSB0150	1090 lb	1090 lb	1090 lb	1090 lb
CSB0200	1885 lb	1885 lb	1885 lb	1885 lb	CSB0200	1370 lb	1370 lb	1370 lb	1370 lb
CSB0250	1885 lb	1885 lb	1885 lb	1885 lb	CSB0250	1370 lb	1370 lb	1370 lb	1370 lb
CSB0300	1885 lb	1885 lb	1885 lb	1885 lb	CSB0300	1431 lb	1431 lb	1431 lb	1431 lb
CSB0400	1885 lb	1885 lb	1885 lb	1885 lb	CSB0400	1772 lb	1772 lb	1772 lb	1772 lb
CSB0500	1885 lb	1885 lb	–	–	CSB0500	1772 lb	1772 lb	–	–
CSB0600	1885 lb	1885 lb	1885 lb	–	CSB0600	1772 lb	1772 lb	1772 lb	–
CSB0800	1885 lb	1885 lb	–	–	CSB0800	1772 lb	1772 lb	–	–
CSB1000	1909 lb	1909 lb	–	–	CSB1000	1909 lb	1909 lb	–	–

FM Loads								
Part Number	Horizontal Capacity per Installation Angle from Vertical							
	Perpendicular to Structure/Lateral				Parallel to Structure/Longitudinal			
	30° – 44°	45° – 59°	60° – 74°	75° – 90°	30° – 44°	45° – 59°	60° – 74°	75° – 90°
<b>FM Approved Lightwall, Sch 10 and Sch 40 Service Pipes</b>								
CSB0100	1,490 lb	2,110 lb	2,580 lb	2,900 lb	1,290 lb	1,240 lb	1,260 lb	1,400 lb
CSB0125	1,380 lb	1,960 lb	2,400 lb	2,690 lb	1,290 lb	1,240 lb	1,260 lb	1,400 lb
CSB0150	1,380 lb	1,960 lb	2,400 lb	2,690 lb	1,200 lb	1,860 lb	2,180 lb	2,250 lb
CSB0200	1,380 lb	1,960 lb	2,400 lb	2,690 lb	1,200 lb	1,820 lb	2,180 lb	2,250 lb
CSB0250	1,440 lb	2,030 lb	2,490 lb	2,790 lb	1,320 lb	1,820 lb	2,190 lb	2,500 lb
CSB0300	1,390 lb	1,970 lb	2,420 lb	2,710 lb	1,300 lb	1,790 lb	2,190 lb	2,500 lb
CSB0400	1,390 lb	1,970 lb	2,420 lb	2,710 lb	1,300 lb	1,790 lb	2,190 lb	2,500 lb
CSB0500	1,390 lb	1,970 lb	2,420 lb	2,710 lb	1,300 lb	1,790 lb	2,190 lb	2,500 lb
CSB0600	1,460 lb	2,060 lb	2,520 lb	2,830 lb	1,410 lb	1,950 lb	2,350 lb	2,680 lb
CSB0800	2,765 lb	N/A	N/A	N/A	2,600 lb	N/A	N/A	N/A
CSB1000	2,800 lb	N/A	N/A	N/A	2,800 lb	N/A	N/A	N/A
<b>0.188" Wall and Sch 40 Service Pipes</b>								
CSB0800	1,330 lb	1,880 lb	2,300 lb	2,580 lb	1,400 lb	1,920 lb	2,350 lb	2,640 lb
CSB1000	1,330 lb	1,880 lb	2,300 lb	2,580 lb	1,400 lb	1,920 lb	2,350 lb	2,640 lb
CSB1200	1,680 lb	2,370 lb	2,910 lb	3,260 lb	1,600 lb	1,860 lb	2,240 lb	2,590 lb

Load ratings for Sch 10 may also be applied to AS 1074 Medium, GB/T 3091, EN 10255 (Medium or Heavy), and JIS G3452 pipe.

Load ratings for Sch 40 may also be applied to AS 1074 Heavy, GB/T 3091, EN 10255 (Heavy), and JIS G3454 pipe.

Load ratings for FM approved lightwall may also be applied to AS 1074 Lightwall, EN 10255 L, EN 10220, and GB/T 8163 pipe.

# Rigid Bracing – Sway Braces

## QUICK GRIP JR. LATERAL SWAY BRACE

- Easy two-step installation eliminates extra trips between structure and service pipe
- Works with 1" and 1 1/4" (25 mm and 32 mm) brace pipes to reduce inventory
- Snap-off bolt head helps enable easy installation and inspection of seismic sway braces
- Meets NFPA®-13 requirements for seismic sway bracing

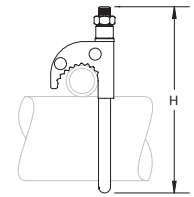
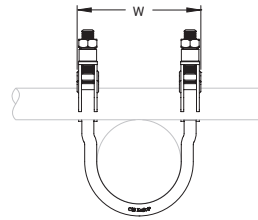

Material: Steel  
Finish: Electrogalvanized



Part Number	Pipe Size	Height H	Width W
CSBQIKCL0100EG	1"	5 1/8"	2 5/8"
CSBQIKCL0125EG	1 1/4"	5 3/8"	3"
CSBQIKCL0150EG	1 1/2"	5 5/8"	3 1/4"
CSBQIKCL0200EG	2"	6 3/8"	3 5/8"

# Rigid Bracing – Sway Braces

UL Loads (Listed for Restraints)			
Part Number	Service Pipe Schedule	Lateral	
		1" Brace Pipe	1 1/4" Brace Pipe
CSBQIKCL0100EG	Dyna-Flow®	N/A	N/A
	10	655 lb	655 lb
	40	655 lb	655 lb
CSBQIKCL0125EG	Dyna-Flow®	655 lb	540 lb
	10	655 lb	540 lb
	40	655 lb	540 lb
CSBQIKCL0150EG	Dyna-Flow®	750 lb	655 lb
	10	750 lb	655 lb
	40	750 lb	655 lb
CSBQIKCL0200EG	Dyna-Flow®	750 lb	540 lb
	10	750 lb	540 lb
	40	750 lb	540 lb

FM Loads					
Part Number	Service Pipe Schedule	Lateral			
		Horizontal Capacity per Installation Angle from Vertical			
		30° – 44°	45° – 59°	60° – 74°	75° – 90°
CSBQIKCL0100EG	Lightwall	290 lb	410 lb	495 lb	550 lb
	10	150 lb	210 lb	280 lb	315 lb
	40	475 lb	665 lb	825 lb	925 lb
CSBQIKCL0125EG	Lightwall	290 lb	410 lb	495 lb	550 lb
	10	150 lb	210 lb	280 lb	315 lb
	40	475 lb	665 lb	825 lb	925 lb
CSBQIKCL0150EG	Lightwall	290 lb	410 lb	495 lb	550 lb
	10	150 lb	210 lb	280 lb	315 lb
	40	475 lb	665 lb	825 lb	925 lb
CSBQIKCL0200EG	Lightwall	390 lb	550 lb	670 lb	750 lb
	10	350 lb	500 lb	620 lb	690 lb
	40	490 lb	690 lb	850 lb	950 lb

# Rigid Bracing – Sway Braces

## QUICK GRIP LATERAL SWAY BRACE

- Easy two-step installation eliminates extra trips between structure and service pipe
- Works with 1" and 1 1/4" (25 mm and 32 mm) brace pipes to reduce inventory
- Yellow tips provide a visual indicator that the bolts have been properly torqued
- Easy installation with an impact wrench from the bottom side of the clamp
- Meets NFPA®-13 requirements for seismic sway bracing

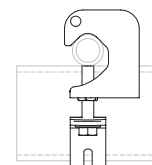
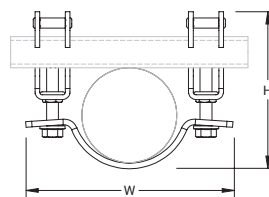

Material: Steel  
Finish: Electrogalvanized



Part Number	Pipe Size	Height H	Width W
CSBQG0250EG	2 1/2"	5 7/16" – 5 7/8"	6 3/4"
CSBQG0300EG	3"	6 1/8" – 6 1/2"	7 1/2"
CSBQG0400EG	4"	7 1/8" – 7 1/2"	8 3/4"
CSBQG0600EG	6"	9 1/4" – 9 5/8"	11 3/4"
CSBQG0800EG	8"	11 3/8" – 11 13/16"	13 7/8"



# Rigid Bracing – Sway Braces

UL Load Rating			
Part Number	Service Pipe Schedule	Load Rating	Bracing Member
CSBQG0250EG	Sch 10, Sch 40, Dyna Flow, Mega-Flow, Eddy Flow, Fire-Flo	1375 lb	1" and 1-1/4" Sch 40 brace pipe
CSBQG0300EG	Sch 10, Sch 40, Dyna Flow, Mega-Flow, Eddy Flow, Fire-Flo	1375 lb	1" and 1-1/4" Sch 40 brace pipe
CSBQG0400EG	Sch 10, Sch 40, Dyna Flow, Mega-Flow, Eddy Flow, Fire-Flo	1375 lb	1" and 1-1/4" Sch 40 brace pipe
CSBQG0600EG	Sch 10, Sch 40, Mega-Flow	1375 lb	1" and 1-1/4" Sch 40 brace pipe
CSBQG0800EG	Sch 10, Sch 40,	1375 lb	1" and 1-1/4" Sch 40 brace pipe

FM Loads					
Part Number	Service Pipe Schedule	Lateral			
		Horizontal Capacity per Installation Angle from Vertical			
		30° – 44°	45° – 59°	60° – 74°	75° – 90°
CSBQG0250EG	Lightwall	1,410 lb	2,000 lb	2,450 lb	2,740 lb
	10	1,410 lb	2,000 lb	2,450 lb	2,740 lb
	40	1,410 lb	2,000 lb	2,450 lb	2,740 lb
CSBQG0300EG	Lightwall	1,190 lb	1,680 lb	2,060 lb	2,300 lb
	10	1,190 lb	1,680 lb	2,060 lb	2,300 lb
	40	1,190 lb	1,680 lb	2,060 lb	2,300 lb
CSBQG0400EG	Lightwall	1,190 lb	1,680 lb	2,060 lb	2,300 lb
	10	1,190 lb	1,680 lb	2,060 lb	2,300 lb
	40	1,190 lb	1,680 lb	2,060 lb	2,300 lb
CSBQG0600EG	Lightwall	870 lb	1,230 lb	1,510 lb	1,690 lb
	10	870 lb	1,230 lb	1,510 lb	1,690 lb
	40	970 lb	1,370 lb	1,680 lb	1,870 lb
CSBQG0800EG	0.188" (Wall Thickness)	790 lb	1,110 lb	1,360 lb	1,520 lb
	40	790 lb	1,110 lb	1,360 lb	1,520 lb

# Rigid Bracing – Sway Braces

## TRAPEZE SWAY BRACE, STRUT

- Meets requirements of the Buy American Act
- Seismically braces trapeze hangers
- Retrofit ability allows for the brace to be installed after the trapeze assembly is installed
- Works with 3/8", 1/2", 5/8", and 3/4" threaded rod
- Compatible with brace members of 12 GA strut type A
- One wrench size fits all required hardware, eliminating the need to change tools
- Shear-off head helps ensure correct torque and simplifies inspection
- FM® Specification Tested

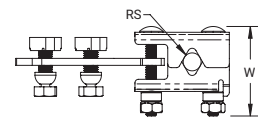
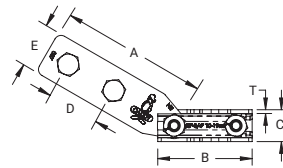

Note: This part is used in conjunction with Structural Attachment CSBUS1 or CSBUS2 – See p. 16

Material: Steel  
Finish: Electrogalvanized



Part Number	Rod Size RS	Width W	Thickness T	A	B	C	D	E
CSBR2	3/8", 1/2", 5/8", 3/4"	3.2"	0.14"	5 1/4"	3.4"	1.13"	1.88"	1.62"

Cut length for strut member is +/- 1" (25 mm) of measured length.

FM Loads		Horizontal Capacity per Installation Angle from Vertical			
Part Number	Brace Member	30° – 44°	45° – 59°	60° – 74°	75° – 90°
		CSBR2	12 GA Strut Channel	1,031 lb	1,812 lb

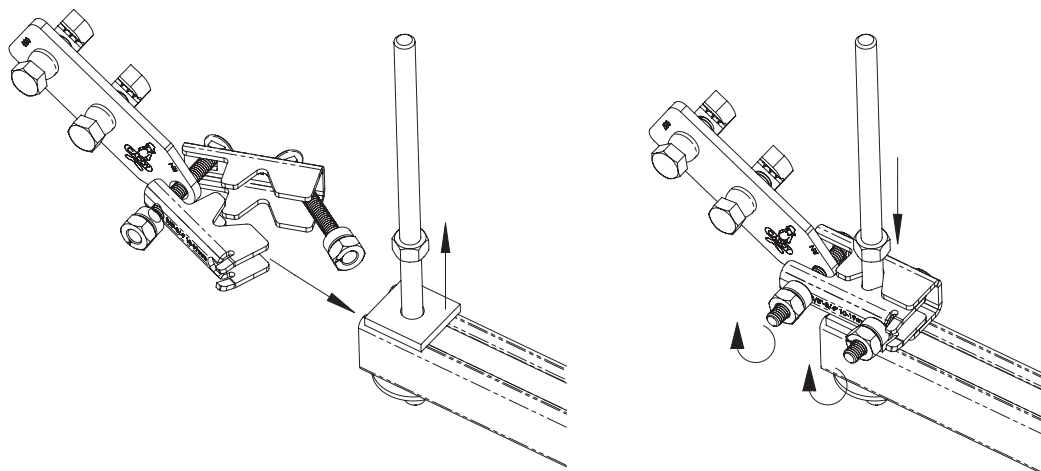

# Rigid Bracing – Sway Braces

## TRAPEZE SWAY BRACE, PIPE

- Meets requirements of the Buy American Act
- Seismically braces trapeze hangers
- Retrofit ability allows for the brace to be installed after the trapeze assembly is installed
- Works with 3/8", 1/2", 5/8", and 3/4" threaded rod
- Works with brace members of schedule 40 pipe, EMT conduit, and rigid conduit
- One wrench size fits all required hardware, eliminating the need to change tools
- Shear-off head helps ensure correct torque and simplifies inspection
- FM® Specification Tested

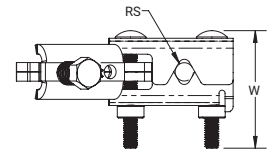
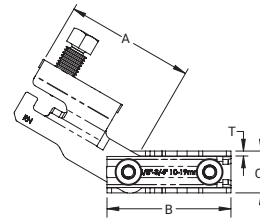
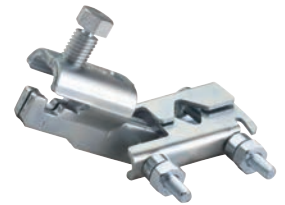

Note: This part is used in conjunction with Structural Attachment CSBU1 or CSBU2 – See p. 18

Material: Steel  
Finish: Electrogalvanized



Part Number	Rod Size RS	Width W	Thickness T	A	B	C
CSBR1	3/8", 1/2", 5/8", 3/4"	3.2"	0.14"	3 1/2"	3.4"	1.14"

FM Loads					
Part Number	Brace Member	Horizontal Capacity per Installation Angle from Vertical			
		30° – 44°	45° – 59°	60° – 74°	75° – 90°
CSBR1	1" EMT Conduit	623 lb	881 lb	1,148 lb	1,148 lb
	1" Rigid Conduit	755 lb	1,109 lb	1,738 lb	1,738 lb
	1" Schedule 40 Pipe	755 lb	1,109 lb	1,738 lb	1,738 lb

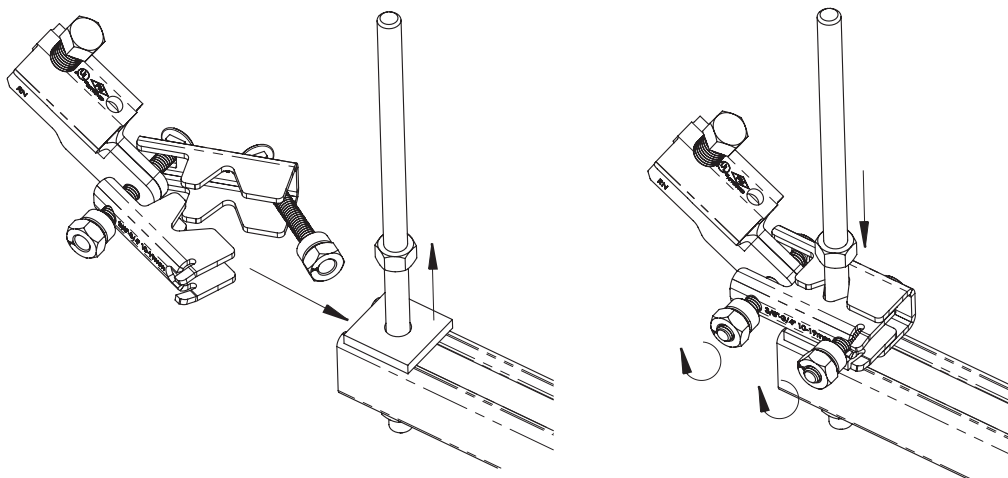

# Rigid Bracing – Sway Braces

## CLEVIS BOLT SPACER

- Seismically braces the 401 Clevis Hanger series for lateral load
- Retrofit ability allows the spacer to be installed after the clevis and pipe are installed
- Ears easily pinch closed around the clevis hanger cross bolt with pliers
- FM® Specification Tested (up to 8" Pipe Size)

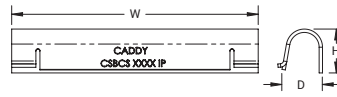

Material: Steel

Finish: ElectroGalvanized

Part Number	Pipe Size	Width W	Height H	Thickness T	Depth D
CSBCS0100	1"	1.21"	0.51"	0.075"	0.51"
CSBCS0125	1 1/4"	1.55"	0.51"	0.075"	0.51"
CSBCS0150	1 1/2"	1.71"	0.51"	0.075"	0.51"
CSBCS0200	2"	2.28"	0.51"	0.075"	0.51"
CSBCS0250	2 1/2"	2.78"	0.67"	0.075"	0.65"
CSBCS0300	3"	3.41"	0.67"	0.075"	0.65"
CSBCS0350	3 1/2"	3.91"	0.67"	0.075"	0.65"
CSBCS0400	4"	4.41"	0.67"	0.075"	0.65"
CSBCS0500	5"	5.50"	0.98"	0.075"	0.90"
CSBCS0600	6"	6.56"	0.98"	0.075"	0.90"
CSBCS0800	8"	8.56"	1.22"	0.075"	1.09"
CSBCS1000	10"	10.52"	1.22"	0.075"	1.09"
CSBCS1200	12"	12.52"	1.22"	0.075"	1.09"

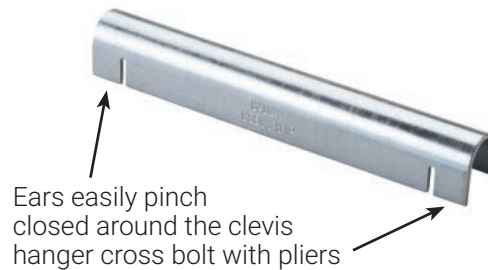

# Rigid Bracing – Replacement Nuts and Bolts

## CONE POINT SHEAR BOLT

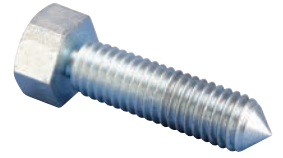

Material: Steel  
Finish: Electrogalvanized

Part Number	For Use With These Products
CSBSB50EG	Steel Flange Adapter (CSBS1, CSBS2) Steel Flange Adapter Assembly (CSBS1A) Adjustable I-Beam Adapter (CSBS3, CSBS4, CSBS5)
CSBUB62EG	Trapeze Sway Brace, Pipe (CSBR1) Universal Structural Bracket (CSBU1, CSBU2) Universal Sway Brace – 1" – 12" sizes (CSBxxxx)

## RIVET HEAD SHEAR BOLT

- One wrench size fits all required hardware, eliminating the need to change tools

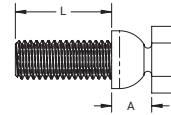

Material: Steel  
Finish: Electrogalvanized

Part Number	For Use With These Products	Width W	Screw Length L	A
CSBSBR50EG	Strut Seismic Hinge Bracket Assembly (CSBUS1PA, CSBUS2PA) Trapeze Sway Brace, Strut (CSBR2) Universal Structural Bracket, Strut Brace (CSBUS1, CSBUS2)	3/4"	1 1/4"	0.52"

## SHEAR NUT



Material: Steel  
Finish: Electrogalvanized

Part Number	For Use With These Products
CSBHN50EG	Universal Sway Brace – 5" – 10" sizes (CSBxxxx)
CSBLN50EG	Universal Sway Brace – 1" – 4" sizes (CSBxxxx)
CSBQIKCLSN37EG	Quick Grip Jr. Lateral Sway Brace (CSBQIKCLxxxxEG)
CSBSN37EG	Adjustable I-Beam Adapter (CSBS3, CSBS4, CSBS5) Trapeze Sway Brace, Pipe (CSBR1) Trapeze Sway Brace, Strut (CSBR2)

# Cable Bracing

## CABLE SPOOL

- Cut to length as needed
- Pre-stretched restraint cable



Stainless steel products are not Buy American Act compliant



Part Number	Brace Size	Diameter	Cable Length	Load Rating	Color	Certifications
<b>Material: Steel   Finish: Pregalvanized; Painted*</b>						
CSB12CBL	#12	3/32"	250'	418 lb	Red	UL
CSB18CBL	#18	1/8"	250'	773 lb	White	UL
CSB36CBL	#36	3/16"	250'	1,909 lb	Blue	UL
<b>Material: Stainless Steel 316 (EN 1.4401)**</b>						
CSB12CBLSS	#12	3/32"	250'	318 lb	-	-
CSB18CBLSS	#18	1/8"	250'	618 lb	-	-
CSB36CBLSS	#36	3/16"	250'	1,318 lb	-	-

\* Source referenced Standard: ASTM A1023/A1023M and the cable is color-coded.

\*\* Source referenced Standard: Federal Specification RR-W-410 Table XL per ASCE/SEI

## OVAL SLEEVE

- Creates secure loop ends
- Swage with swaging tools



Stainless steel products are not Buy American Act compliant



Material: Copper

Finish: Electrogalvanized

Part Number	Brace Size
<b>Material: Copper   Finish: Electrogalvanized</b>	
CSB12SLVB	#12 (Red)
CSB18SLVB	#18 (White)
CSB36SLVB	#36 (Blue)

Part Number	Brace Size
<b>Material: Stainless Steel 316 (EN 1.4401)</b>	
CSB12SLVBSS	#12 (Red)
CSB18SLVBSS	#18 (White)
CSB36SLVBSS	#36 (Blue)

Two side-by-side swages required on #12 and #18 cable. Three side-by-side swages required on #36 cable. Check swage with gauge (not included).

# Cable Bracing

## CABLE CUTTER

- Designed to reduce cable fraying

Material: Steel

Part Number	Brace Size
SLWC	#12 (Red), #18 (White)
CSBC48	#36 (Blue)



SLWC



CSBC48

## NO PRY CLIP

- Eliminates prying effect on fasteners and anchors

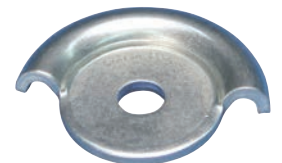
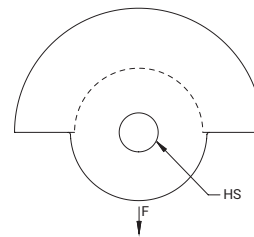

Material: Steel  
Finish: Electrogalvanized

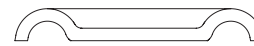

Part Number	Brace Size	Hole Size HS	UL Listed Load
CSBNPC38	#12, #18, #36	7/16"	1,909 lb
CSBNPC12	#12, #18, #36	9/16"	1,909 lb
CSBNPC58	#12, #18, #36	11/16"	1,909 lb

CSBNP34 is make to order (MTO) part

## UNIVERSAL RESTRAINT CLIP, RETROFIT

- Slotted design ideal for attaching to existing threaded rod on trapezes

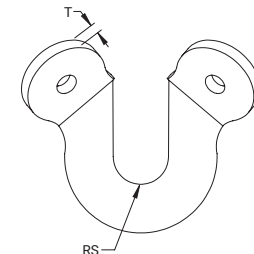

Material: Steel  
Finish: Electrogalvanized



Part Number	Brace Size	Rod Size RS	Thickness T	UL Load Rating
CSBURCR38	#12, #18	3/8"	1.68"	773 lb
CSBURCR12	#12, #18	1/2"	1.68"	773 lb
CSBURCR58	#12, #18	5/8"	1.68"	773 lb

# Cable Bracing

## UNIVERSAL RESTRAINT CLIP

- Attaches cable brace to structure
- Attaches to threaded rod for trapeze bracing applications

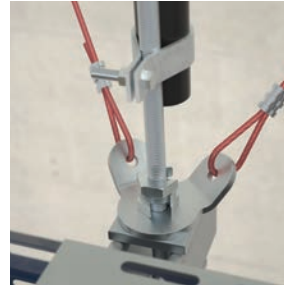
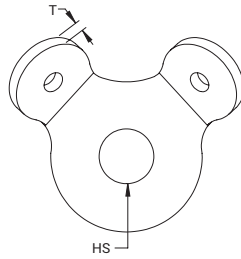

Part Number	Brace Size	Hole Size HS	Thickness T	Load Rating	Certifications
<b>Material: Steel   Finish: Electrogalvanized*</b>					
CSBURC38	#12, #18	7/16"	0.168"	773 lb	UL
CSBURC12	#12, #18	9/16"	0.168"	773 lb	UL
CSBURC58	#12, #18	11/16"	0.168"	773 lb	UL
CSBURC34 ***	#12, #18,	13/16"	0.168"	773 lb	-
CSBURC78 ***	#12, #18	15/16"	0.168"	773 lb	-
<b>Material: Stainless Steel 316 (EN 1.4401)**</b>					
CSBURC14SS	#12, #18, #36	5/16"	0.168"	1,318 lb	-
CSBURC38SS	#12, #18, #36	7/16"	0.168"	1,318 lb	-
CSBURC12SS	#12, #18, #36	9/16"	0.168"	1,318 lb	-
CSBURC58SS	#12, #18, #36	11/16"	0.168"	1,318 lb	-
CSBURC34SS	#12, #18, #36	13/16"	0.168"	1,318 lb	-
CSBURC78SS	#12, #18, #36	15/16"	0.168"	1,318 lb	-

Mount to the structure using the center hole. Loop cable through the holes in the bent tabs and swage in place. Fitting must develop the cable minimum breaking strength, fittings load rating is equivalent to cable rating.

\* Source referenced Standard: ASTM A1023/A1023M and the cable is color-coded.

\*\* Source referenced Standard: Federal Specification RR-W-410 Table XL per ASCE/SEI

\*\*\* CSBURC34 and CSBURC78 and make to order (MTO) parts



# Cable Bracing

## URC ATTACHMENT KIT

- Attaches cable brace to structure
- Two-way bracing kit with oval sleeves
- Wraps around structural steel members

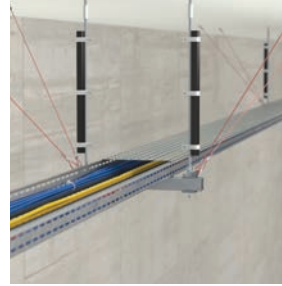

Material: Steel

Finish: Electrogalvanized; Painted



Part Number	Hole Size	Brace Length	Cable Length	UL Listed Load
<b>Brace Size: #12   Color: Red</b>				
CSB2W12URC38L10	7/16"	10'	14'	418 lb
CSB2W12URC38L20	7/16"	20'	24'	418 lb
CSB2W12URC12L10	9/16"	10'	14'	418 lb
CSB2W12URC12L20	9/16"	20'	24'	418 lb
<b>Brace Size: #18   Color: White</b>				
CSB2W18URC38L10	7/16"	10'	14'	773 lb
CSB2W18URC38L20	7/16"	20'	24'	773 lb
CSB2W18URC12L10	9/16"	10'	14'	773 lb
CSB2W18URC12L20	9/16"	20'	24'	773 lb
<b>Brace Size: #36   Color: Blue</b>				
CSB2W36URC12L10	9/16"	10'	14'	1,100 lb
CSB2W36URC12L20	9/16"	20'	24'	1,100 lb
CSB2W36URC58L10	11/16"	10'	14'	1,100 lb
CSB2W36URC58L20	11/16"	20'	24'	1,100 lb

# Cable Bracing

## BATTERY-OPERATED SWAGING TOOL

- Battery-operated tool provides consistent swaging
- Provides less strenuous installation when compared to manual swaging tools
- Cordless design allows installers to easily move around the job site
- Compatible with large diameter cables
- Reduces the number of swages per sleeve – saving time of installation



Material: Steel

Part Number	Brace Size
CSBBS121836	#12 (Red), #18 (White), #36 (Blue)

## MANUAL SWAGING TOOL

Material: Steel



Part Number	Brace Size
CSB12SBHS	#12 (Red)
CSB48	#48 (Yellow)

## MULTI-SIZE MANUAL SWAGING TOOL

Material: Steel



Part Number	Brace Size
CSB3346SB	#12 (Red), #18 (White), #36 (Blue)

# Rod Stiffeners

## NVENT CADDY QUICK CLIP ROD STIFFENER

- Secures strut channel to threaded rod for stiffening
- One hand, snap-in place installation
- No tools or bolt tightening required

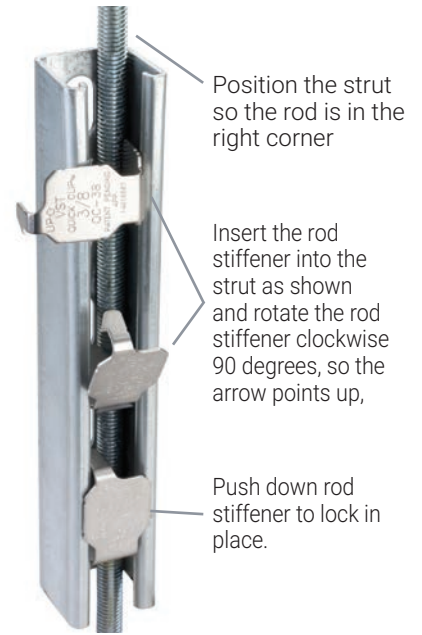
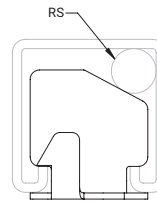
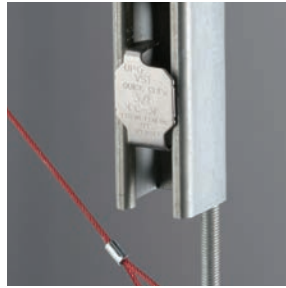

Material: Stainless Steel 316 (EN 1.4401)

Part Number	Strut Type	Rod Size RS
CSBRS2	A (1 5/8" x 1 5/8")	3/8"
CSBRS3	A (1 5/8" x 1 5/8")	1/2"
CSBRS4	A (1 5/8" x 1 5/8")	5/8"
CSBRS5	A (1 5/8" x 1 5/8")	3/4"
CSBRS6	A (1 5/8" x 1 5/8")	7/8"

## STRUT ROD STIFFENER

- Secures strut channel to threaded rod for stiffening

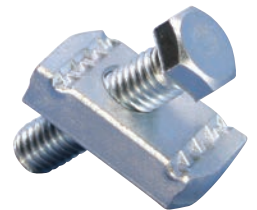
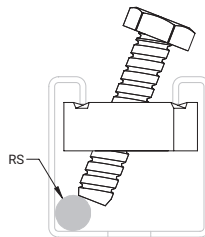

Material: Steel  
Finish: Electrogalvanized

Part Number	Strut Type	Rod Size RS
CSBRS37EG	A (1 5/8" x 1 5/8")	3/8", 1/2", 5/8", 3/4"

## PIPE ROD STIFFENER

- For use with Schedule 40 or Schedule 10 pipe
- Secures pipe to threaded rod for stiffening

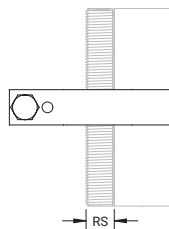

Material: Steel  
Finish: Electrogalvanized

Part Number	Brace Pipe Size	Rod Size RS
CSBRS1	1"	3/8", 1/2", 5/8"

# nVent CADDY Pyramid Rooftop Anchor System

nVent CADDY Pyramid Rooftop Anchor Systems help ensure the safety and protection of your rooftop mechanical and electrical equipment applications. The system fastens directly to the roof deck. The anchor is permanently sealed to the roof membrane, creating a watertight barrier. The system offers a superior method of securing rooftop equipment by replacing evasive anchoring techniques and ballasting. Pyramid Rooftop Anchor Systems provide contractors with high-quality products and engineering services.

## FEATURES

---

- System requires minimal roof membrane penetration
- Elimination of ballasting significantly reduces weight to roof structure
- Speed of installation results in lower total installed cost
- System preserves membrane manufacturers' warranty
- Design and engineering services are available, from simple layouts to PE stamped designs
- Combines with other Pyramid products for a total rooftop solution

### ROOFTOP ANCHOR

---

This watertight, membrane-matching rooftop anchor utilizes a threaded stud for bracing applications.



### ROOFTOP ANCHOR CABLE BRACING

---

This watertight, membrane-matching rooftop anchor utilizes a threaded stud for bracing applications.



### DECK SCREW

---

Secures nVent CADDY Pyramid Rooftop Anchors to various roof substrate materials

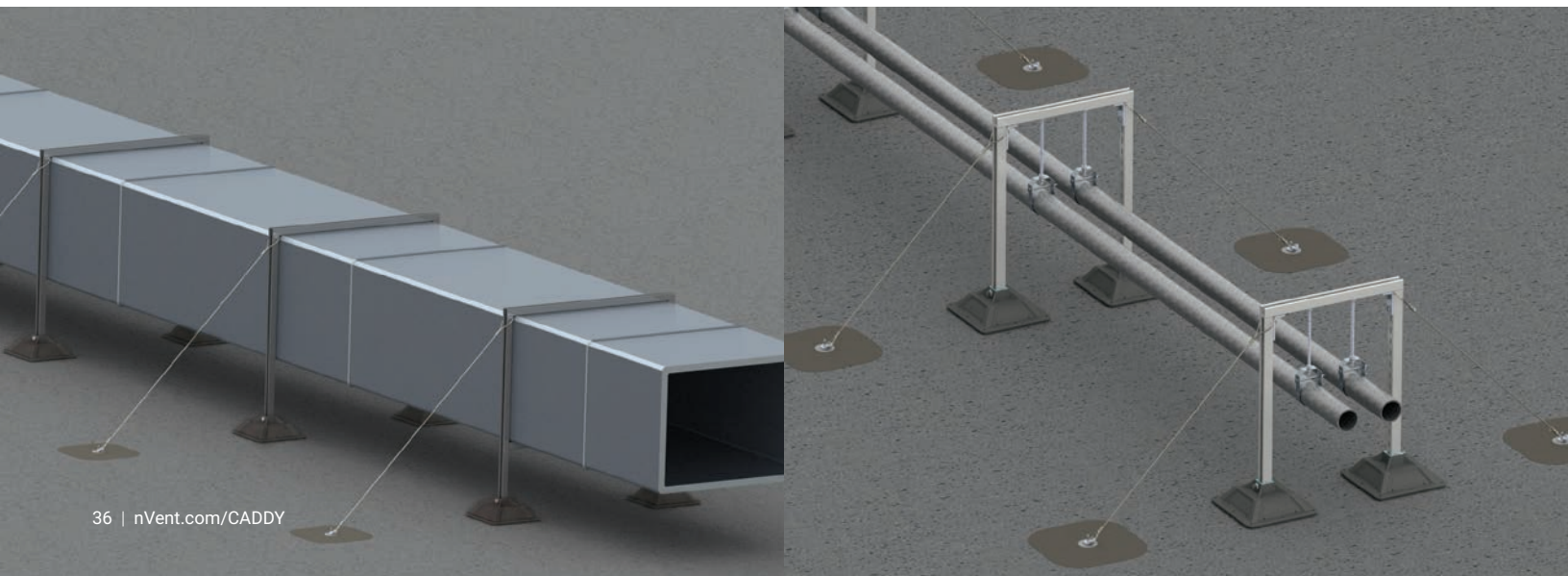

# nVent CADDY Pyramid Rooftop Anchor System

## NVENT CADDY PYRAMID ROOFTOP ANCHOR

- Anchors require minimal roof membrane penetration
- System preserves membrane manufacturers' warranty
- Matching membrane material allows for consistent performance and aesthetic
- Installation creates a watertight seal, limiting water intrusion and damage to the structure

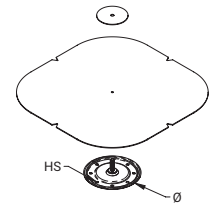
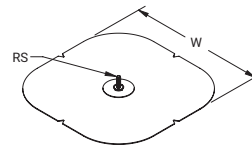
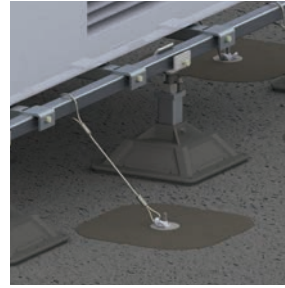

Material: Steel  
Finish: ElectroGalvanized

Part Number	Membrane Manufacturer	Color	Rod Size RS	Diameter Ø	Hole Size HS	Width W
<b>Material: EPDM-SBR Rubber</b>						
CRAU24EB1C	CARLISLE®	Black	3/8"	5 1/2"	0.275"	11 3/4"
<b>Material: Modified Asphalt</b>						
CRAU26SW12C	CERTAINTED®	-	3/8"	5 1/2"	0.275"	18"
<b>Material: Polyvinylchloride</b>						
CRAU24PW3J	JOHNS MANVILLE®	White	3/8"	5 1/2"	0.275"	11 3/4"
CRAU24PW8S	SIKA SARNAFIL®	White	3/8"	5 1/2"	0.275"	11 3/4"
<b>Material: Thermoplastic Polyolefin (TPO)</b>						
CRAU24TW1C	CARLISLE®	White	3/8"	5 1/2"	0.275"	11 3/4"
CRAU24TW2F	FIRESTONE®	White	3/8"	5 1/2"	0.275"	11 3/4"
CRAU24TW3J	JOHNS MANVILLE®	White	3/8"	5 1/2"	0.275"	11 3/4"
CRAU24TW4G	GAF®	White	3/8"	5 1/2"	0.275"	11 3/4"

Anchor system must be installed by a certified roofing contractor according to membrane manufacturer's guidelines to preserve membrane warranty.

# nVent CADDY Pyramid Rooftop Anchor System

## NVENT CADDY PYRAMID ROOFTOP ANCHOR CABLE BRACING

- Stainless steel components of cable assembly provides superior corrosion performance
- Multiple length configurations provide flexibility for various installations
- Pre-assembled cable terminations enable easy installation

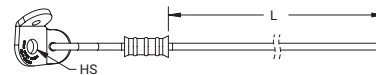

Material: Stainless Steel 316 (EN 1.4401)

Part Number	Brace Size	Length L	Hole Size HS
CRA36SS38L2	#36	6.6'	7/16"
CRA36SS38L3	#36	9.8'	7/16"
CRA36SS38L4	#36	13.1'	7/16"

## NVENT CADDY PYRAMID ROOFTOP ANCHOR CABLE BRACING

- Secures nVent CADDY Pyramid Rooftop Anchors to various roof substrate materials



Material: Steel  
Finish: Epoxy Coated  
Color: Black

Part Number	Screw Diameter	Screw Length
A927W001P100	#14	2"
A927W002P100	#14	3"
A927W003P100	#14	4"
A927W004P100	#14	5"
A927W005P100	#14	6"
A927W006P100	#14	7"
A927W007P100	#14	8"

#14 deck screws are for general purpose use.

Part Number	Screw Diameter	Screw Length
A927W008P100	#15	2"
A927W009P100	#15	3"
A927W010P100	#15	4"
A927W011P100	#15	5"
A927W012P100	#15	6"
A927W013P100	#15	7"
A927W014P100	#15	8"

#15 deck screws are specially suited for OSB and light gauge steel.

# Related Products

## SEISMIC LIGHTING FIXTURE CLAMP

- Secures fluorescent light fixtures to the ceiling frame members
- Requires no additional chains, cables or slack wires attached to the fixture
- Helps strengthen integrity of the T-Grid system
- Holds in place against the force of standard fire-hose pressure
- Meets U.S. building code and electrical code specifications
- Also satisfies NEC® 410.16(C) positive attachment for secure fastening of luminaires (fixtures) complying with Building Code Reference AC184



Material: Steel  
Finish: Plain



Part Number	Fixture Configuration	Standard Packaging Quantity
SFCLT	One Standard Tapered 2' x 4' Fixture	25 x 4 pc
SFCLTCF	One 2' x 2' Fixture	50 x 2 pc
SFCLTCFS	Reinforcement of T-Bar Main Runner/Cross Runner Connections	50 x 2 pc
SFCLTE	Two Standard Tapered 2' x 4' Fixtures End-to-End	25 x 2 pc
SFCLTS	Two Standard Tapered 2' x 4' Fixtures Side-by-Side	25 x 2 pc

Tested for compliance to the UBC, NEC®, NBC, and CEC.

## RS RETROFIT RETAINER STRAP

- Ideal for both new and existing applications
- Can be installed without disassembly of the hanging system and/or removing the clamp
- Compatible with all standard nVent CADDY beam clamps and can be secured to either the set screw or threaded rod
- Large teardrop-shaped opening is compatible with multiple threaded rod diameters, reducing inventory by 50%
- Coined edge on teardrop-shaped opening locks into rod, eliminating shifting during install
- Provides a secure attachment in seismic zones and complies with NFPA® requirements
- Meets the UL® load test for retainer straps (3/8" and 1/2" rod sizes)



# Related Products

## NVENT CADDY ROD LOCK TELESCOPING STRUT REPLACEMENT

- Easy “push-to-install” design allows installers to simply push the threaded rod through the mounting hole, instantly holding it in position

– Part No: **TSR122038RL**



## TELESCOPING STRUT REPLACEMENT

- Captive threaded nuts enable fastening to threaded rod supports without loose parts

– Part No: **TSR122025, TSR1220**



## TELESCOPING STRUT REPLACEMENT, NO NUT

- Can be attached directly to a wall for wall-mounted applications

– Part No: **TSR1220N**



## TELESCOPING STRUT REPLACEMENT, RETROFIT

- Slotted ends allow the bracket to be installed with four nVent CADDY SN Nuts on threaded rod above an existing trapeze, saving contractor time and limiting building downtime

– Part No: **TSR1220R**

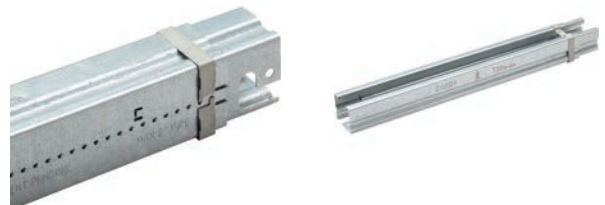

## SNSW FLANGED NUT

- Ideal for retrofit projects, such as trapeze installations, where disassembly of the support system is not desired
- Use as a stopper when installing nVent CADDY Rod Lock assemblies
- Can be easily installed, removed, and repositioned at any location along the threaded rod
- Ready to use out of the box and eliminates multiple pieces of standard hardware
- Functions as a hex nut and flat washer combined
- Washer is wide enough to work with standard strut channel profiles

– Part No: **SNSW37, SNSW50**

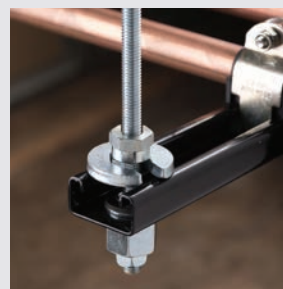



# Related Products

## TELESCOPING PIPE STAND

- Supports and fastens low to the ground horizontal pipe runs
- Complete out-of-the-box assembly provides a compact solution, simplifying material handling and reducing the amount of storage space required
- Designed to minimize fabrication and reduce the installation time of a complete stand by up to 80%
- Telescoping post provides fast vertical height adjustment
- V-bolt fastener accommodates multiple pipe sizes, reducing inventory by over 65%
- Easy “push-to-install” nVent CADDY Rod Lock feature allows the V-bolt to assemble quickly
- Integrated weep hole at bottom of stand provides drainage for condensation
- Conforms with Federal Specification WW-H-171 (Type 37, 38), Manufacturers Standardization Society ANSI®/MSS-SP-58 (Type 37)

– Part No: CTS04, CTS10



## HANGERMATE® HORIZONTAL MOUNT SCREW FOR STEEL WITH LOCK NUT

- Convenient design allows fast and easy installation
- Eliminates the need for labor-intensive operations, such as pre-punching or drilling of steel components
- Only one driver needed for all anchor sizes
- Cross-drilled and tapped head permits horizontal mounting of threaded rod systems

– Part No: HMZH476



## SN SERIES NUT

- Allows side mounting of nut to threaded rod
- Reduces the need for threading compared to standard nuts and washers
- Ideal for retrofit projects, such as trapeze installations, where disassembly of the support system is not desired
- Works with slightly damaged threads and minor burrs on the threaded rod
- Reduces installation time up to 50%

– Part No: SN25, SN37, SN50

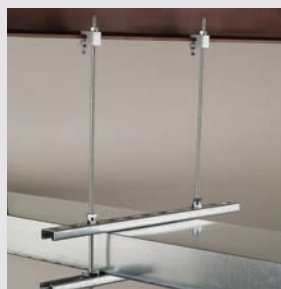

# Related Products

xxxx designated in the part numbers refers to parts with multiple sizes and/or finishes available.

## 401 CLEVIS HANGER

- Recommended for the suspension of stationary non-insulated pipe lines
- Flared edges help prevent sharp surfaces from coming into contact with the pipe (1/2" to 2" pipe sizes)
- Clevis bottom pivots to allow pipe to be fed from either direction
- Conforms with U.S. Federal Specification WW-H-171 (Type 1), Manufacturers Standardization Society (MSS) SP-58 (Type 1)
- Available for pipe sizes from 1/2" to 24"

– Part No: 401xxxx

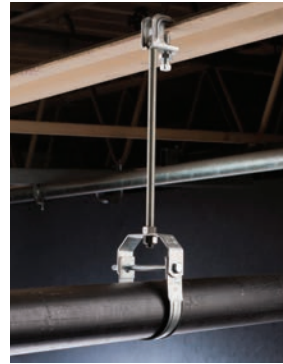

## PIPE CLAMPS



nVent CADDY Superfix  
454 Standard Duty

– Part No: 454xxxx



nVent CADDY Macrofix  
Plus NI EZ with Easy  
Closure

– Part No: 429xxxx



455 Malleable  
Split Ring Hanger

– Part No: 455xxxx



nVent CADDY EZ Riser

– Part No: EZRxxxx

## STRUT CLAMPS



SCH2 Single Piece Strut  
Clamp for Cable/Conduit

– Part No: SCHxxB



RIGD/COPC Single Piece Strut  
Clamp for Pipe/Rigid Conduit/  
Copper Tube

– Part No: RIGDxxx, COPCxxxx



nVent CADDY Swift Clip  
Strut Clamp for Tube/Pipe

– Part No: TMSxxxx



nVent CADDY Cushion  
Clamp Insulated Strut  
Clamp for Pipe/Tube

– Part No: CCCxxxx

# Related Products

xxxx designated in the part numbers refers to parts with multiple sizes and/or finishes available.

## SIDE BEAM ATTACHMENTS

---

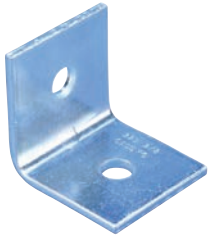

325 Steel Side Beam Attachment

– Part No: 325xxxx



327 Malleable Iron Side Beam Attachment

– Part No: 327xxxx



328 Threaded Steel Side Beam Attachment

– Part No: 328xxxx



329 Side Beam Attachment

– Part No: 329xxxx



37 Steel Eye Socket Rod Hanger

– Part No: 03700xxxx



38 Offset Steel Eye Socket Rod Hanger

– Part No: 03800xxxx

Our powerful portfolio of brands:

**CADDY ERICO HOFFMAN RAYCHEM SCHROFF TRACER**



[nVent.com/CADDY](https://www.nVent.com/CADDY)