



CONNECT AND PROTECT

nVent ERIFLEX Flexible Conductors

Solutions to Optimize the Design of Electrical Power and
Grounding & Bonding Connections

nvent

ERIFLEX

Table of Contents

nVent ERIFLEX Flexible Conductors for Low-Voltage Industries.....	4
nVent ERIFLEX Flexible Conductors for Various Applications.....	6
Certificates & nVent ERIFLEX Software.....	8
Product Overview.....	9
nVent ERIFLEX Flexibar Advanced.....	10
nVent ERIFLEX Flexibar Advanced Part Numbers.....	15
Accessories.....	17
nVent ERIFLEX Flexibar Hydraulic Work Center.....	21
nVent ERIFLEX Flexibar Manual Work Center.....	22
Flat Insulated Braided Conductor IBS/IBSB Advanced.....	23
Main Technical Specifications.....	25
Dimension and Packing Unit.....	26
How to select nVent ERIFLEX IBS & IBSB Advanced.....	27
IBS & IBSB Advanced Connection on Molded Case Circuit Breaker.....	28
Round Insulated Braided Conductor IBS Advanced.....	29
Advanced Insulated Braided IBSHY Conductor for Compact Circuit Breakers.....	31
Grounding and Bonding tinned Copper Braids (MBJ & BJ).....	34
Grounding and Bonding Braid, Tinned Copper with Halogen Free & Flame retardant Yellow Green insulation.....	36
Grounding & bonding braidStainless steel braids (CPI).....	38
Grounding and Bonding Braid, CPIW Stainless Steel for Large Bolts.....	40
Power Shunt (PBC).....	42
Presswelded Power Shunts (PPS).....	43
Flat Copper & Stainless Steel Braids (FTCB, FRCB, FSSB & FTCBI).....	44
Round & Tubular Copper Braids (RTCB, RRCB, RRCT, TTCE).....	45
Round Copper Braids (RRCBI & RTCBI).....	46
Make Your Own Braided Connections.....	47
Made to Order Solutions (MTO).....	48
Cross Reference List.....	50

nVent ERIFLEX Flexible Conductors for Low-Voltage Industries

NVENT OFFERS

- A worldwide team of experts in electrical power connections
- Global solutions manufacturing
- Complete range of high-quality, reliable, certified products
- Innovative and compatible product solutions

ENERGY

- Electrical Power Generators and Distribution
 - Transformers
 - Generators
- Renewable Energies
 - Windmills
 - Solar
 - Hydropower
- Oil, Gas and Petrochemical
- Telecom
- Power Stations



BEFORE



TRANSPORTATION

- Marine
- Aircraft
- Ground Transportation
- Automotive





INDUSTRY & BUILDINGS

- Air Conditioning
- Elevators, Escalators & Automatic Doors



PANELBOARD

- Power
- Control & Command Applications:
 - Power Switchboards
 - Distribution Panel
 - UPS
 - Power Factory Correction

AFTER



MACHINERY

- Tunneling
- Crushers
- Printing
- Welding
- Packaging
- Woodworking

nVent ERIFLEX Flexible Conductors for Various Applications

nVent ERIFLEX is well-known for producing high quality flexible conductors for low voltage power connections. Flexible conductors made out of braids or laminates are used in a variety of applications for current transfer or grounding/earthing connections.



Worldwide certifications, applications and product availability

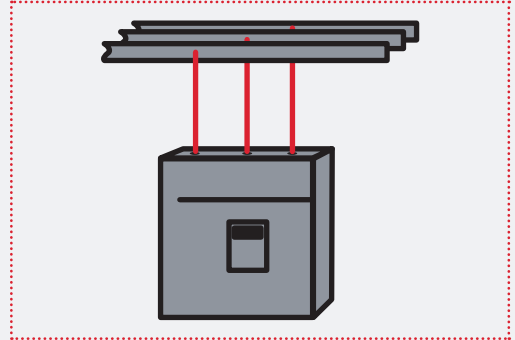

Busbar and active electrical component connection (Example: circuit breaker, contactor) including most compact components on the market

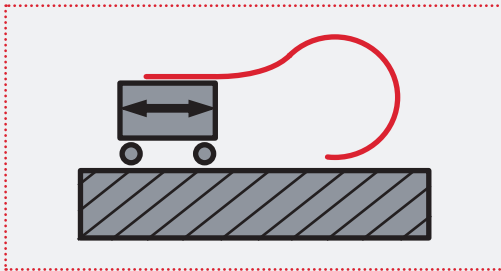

Flexible connection between fixed and moving parts

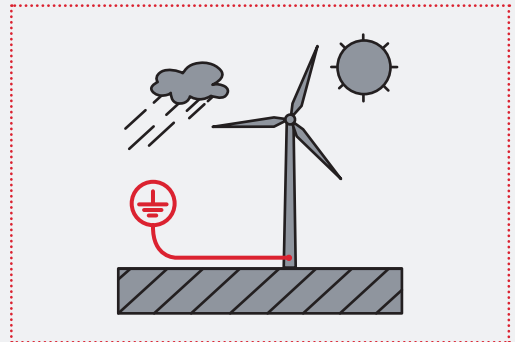

Outdoor/offshore application or difficult environment (Example: abrasion, corrosion, UV)

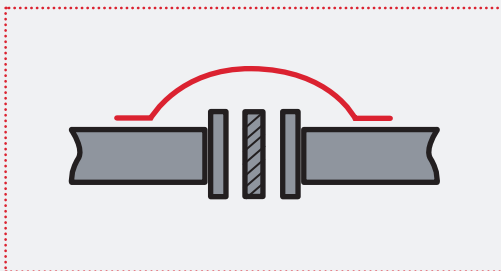

Earthing/grounding interconnection (Example: pipeline)

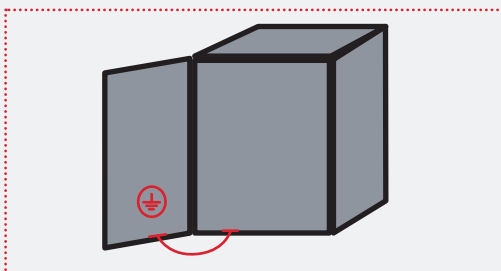

Earthing/grounding connection with excellent electro-magnetic compatibility

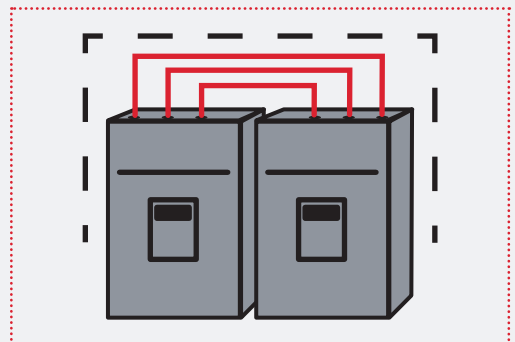

Short and compact connection between electrical components for volume reduction

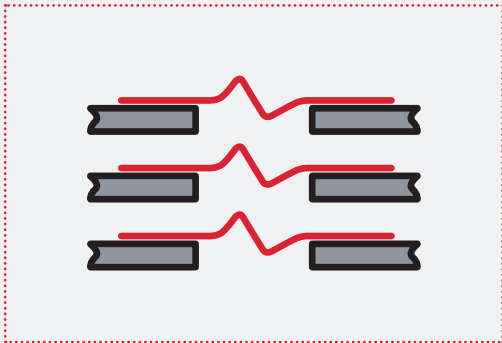

Expansion connections for busbar systems

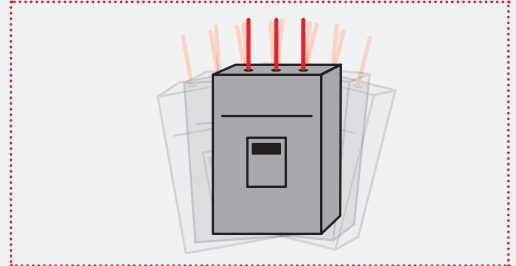

Vibration and reliability solution for connection

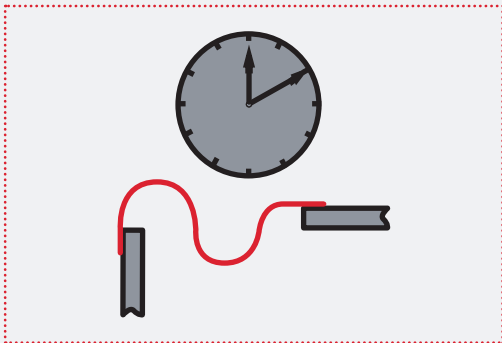

Reduce time assembly or maintenance connection

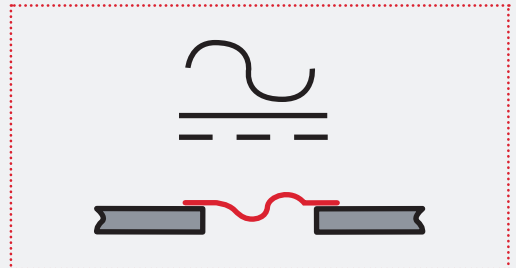

Connection for alternating current or direct current application

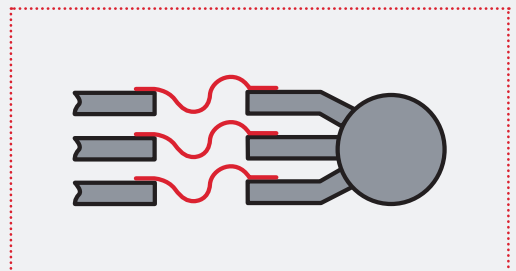

Motor, generator or transformer connection with busbar system

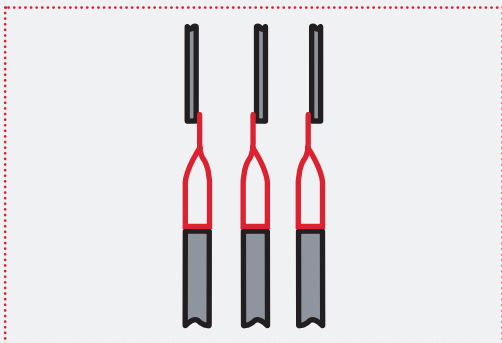

Power connection between horizontal and vertical system

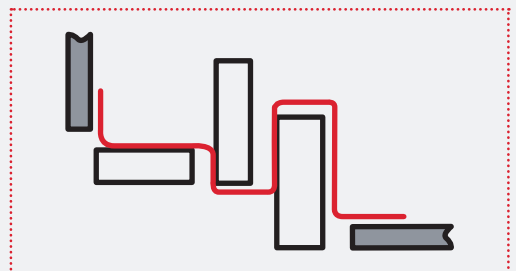

Connection everywhere

Certificates & nVent ERIFLEX Software

TESTS & CERTIFICATES

nVent ERIFLEX components are compliant with several agencies and standards to meet all requirements

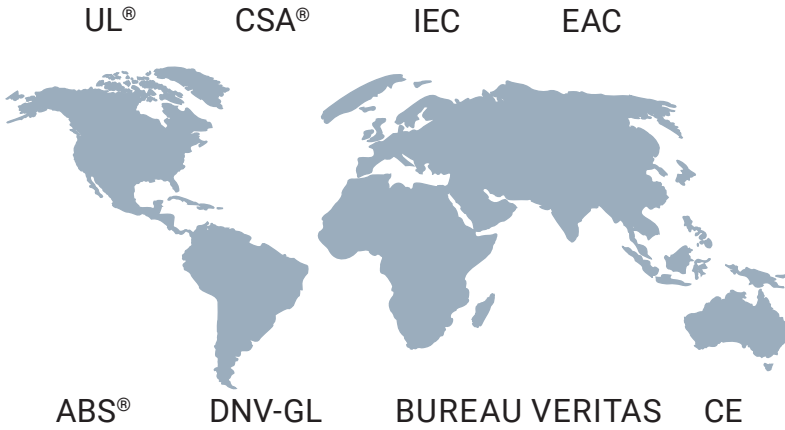

DEDICATED NVENT ERIFLEX SOFTWARE AVAILABLE

nVent has designed an interactive software that allows drawing your technical panel layout with all components and relevant information on them.

The software is developed according to the new IEC 61439-1 standard. Inside, you will discover: updated pricing, products information and project calculator.

Whether you're interested in making a complete low-voltage busbar system, a distribution kit, or if you need to determine a flexible connection with nVent ERIFLEX Flexibar, you can trust nVent ERIFLEX software to help simplify the process.

The software will also provide you with technical and commercial datasheets dedicated to your project.

For more information or to request your personal login information, contact your local nVent representative or visit eriflex-configurator.nVent.com/eriflex

A COMPLETE SOLUTION FOR:

- Optimal design
- Standard compliance
- Cost effective
- Quality environment



<https://eriflex-configurator.nVent.com/eriflex/>



International Electrotechnical Commission
IEC 60439.1 Standard
IEC 61439.1 Standard



Underwriters Laboratories
UL Recognized, File No. E125470
UL Recognized, File No. E220029
UL Recognized, File No. E316390



UL Listed, File No. E220029



Canadian Standards Association
CSA Certified, File No. LL 90005
CSA Certified, file No 700 443 70



European Conformity



ABS American Bureau of Shipping
Certificate No. 08-HS365878-1-PDA-DUP & Certificate No. 13-HS1018106-1-PDA-DUP
Marine & Offshore Applications



Bureau VERITAS
Certificate No. 02859 / DO BV for shipboard use



A dedicated certification for Marine and Off Shore for nVent ERIFLEX IBS/IBSB Advanced



European Union standard fire testing to rail way components



EAC
Certificate compliance for Russia



RoHS Compliant



Halogen free material as per UL and IEC



Flame retardant



Low smoke

Product Overview

Product Range	Typical Uses	Typical Market
nVent ERIFLEX Flexibar: Advanced 	<ul style="list-style-type: none"> • Heavy-duty power interconnection • Overcome vibration/alignment problems • Circuit breaker, generator & prefabricated power network conductor • Expansion joints • Variable terminating positions • Machine connections • Movable connection from massive busbar system • Alternative to large & multiple cables • Alternative to rigid busbar 	<ul style="list-style-type: none"> • Switchgear & control equipment • Transportation • Electrical equipment manufacturers • Power generation • Machinery manufacturer
Insulated braided conductor (IBS/IBSB Advanced & IBSHY) 	<ul style="list-style-type: none"> • Interconnects for low voltage power distribution units • IBSB specially designed for industrial circuit breaker connection • Overcome vibration/alignment problems • Battery connections • Earth/ground connections 	<ul style="list-style-type: none"> • Switchgear & control equipment • Transportation • Electrical equipment manufacturers • Power generation
Power shunt (PBC & PPS) 	<ul style="list-style-type: none"> • Transformer or generator to busbar connection • Overcome vibration/alignment problems • Power interconnection 	<ul style="list-style-type: none"> • Switchgear & control equipment • Power distribution • Transportation
Earth/ground copper braids (MBJ, MBJYG & BJ) 	<ul style="list-style-type: none"> • Power, earthing/grounding and equipotential connections • Electrical bonding enclosure door • EMI effect reduction application 	<ul style="list-style-type: none"> • Switchgear & control equipment • Rail transportation • Electrical equipment manufacturers • Power generation (wind, solar) • Data center
Earth/ground stainless steel braids (CPI & CPIW) 	<ul style="list-style-type: none"> • Earthing/grounding and equipotential connections • Superior abrasion, corrosion, chemical, and UV resistance for outdoor applications • Expansion joints • Connections for lightning protection systems 	<ul style="list-style-type: none"> • Transportation • Food and beverage industry • Power generation (wind, solar) • Chemical and oil industry • Automotive • Defense & aerospace • Civil construction • Urban projects
Flat and round copper braids in coils 	<ul style="list-style-type: none"> • Earth/ground connections • Power interconnection • Lightning protection • Flexible links • Overcome vibration/alignment problems 	<ul style="list-style-type: none"> • Defense & aerospace • Rail transportation • Automotive • Electronics • General electrical sector • Civil construction
Tubular copper braids in coils 	<ul style="list-style-type: none"> • Screening of cables from electromagnetic, electrostatic and RF interference • Mechanical support • Protection against abrasion and corrosion • EMC & EMH applications 	<ul style="list-style-type: none"> • Defense & aerospace • Transportation • Electronics & communication • Cable harness & assembly makers • Component distributors

nVent ERIFLEX Flexibar Advanced

A COMPLETE RANGE OF INSULATED FLEXIBLE BUSBAR

- Patent insulation on nVent ERIFLEX Flexibar:

- Advanced



THE REFERENCE CONDUCTOR

- Flexibar is composed by with multiple layers of thin electrolytic tinned copper
- Flexibar connections are made by punching directly through the laminates. There are no lugs to purchase, which eliminates faulty connection problems and makes installation easier and faster
- The insulation is a high-resistance, self-extinguishing TPE
- Traceability code and designation Part Number on product
- Easily formed, Flexibar improves assembly flexibility and aesthetics of panels
- Optimal alternative to large cable & rigid busbar
- Quality: 100% production dielectric tested
- Full range from 24 mm² up to 1200 mm²

ENHANCED FLEXIBILITY

nVent's exclusive manufacturing process offers superior flexibility:

- Copper laminates are free to slide within the insulation
- High insulation quality
- Wide variety of bending, twisting & folding possibilities

FEATURES

- Self-extinguishable/flame retardant
- High mechanical resistance
- High elongation value
- Withstands high currents
- High copper quality (99.9% purity)
- High conductivity

INNOVATIVE PATENT INSULATION

Flexibar has added grooves on the inner surface of the insulation sleeve to improve sliding between the central conductor and the insulation material. The grooves help to reduce the contact surface between the central conductor and the insulation material. This results enhances the flexibility of the flexible busbar.

Result: <20% of the inner surface is in contact with the central conductor.

This nVent ERIFLEX patent idea makes Flexibar more flexible than ever and allows users to optimize the design of their electrical power connection.

* This patent is applicable for the cross section indication by "*" on the part number.

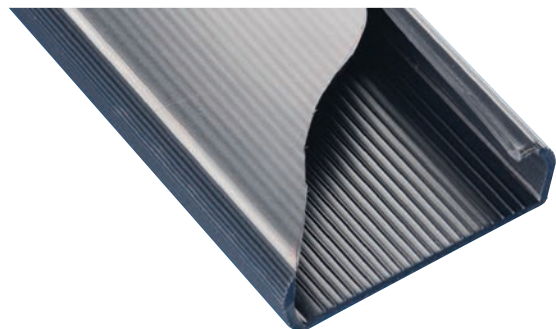

CONNECTION TYPES

- Between main power and distribution equipment (contactors, circuit-breakers)
- Between transformer and busduct
- Between busduct and electrical cabinet

SPACE/WEIGHT SAVINGS

- Less installation space compared to cable
- Reduces the length, number of conductors and weight
- Insulation allows for closer spacing than traditional busbar designs

COST SAVINGS

- Eliminates cost and installation of lugs
- Reduces inventory costs

IMPROVES RELIABILITY

- Flexibar is directly connected thus eliminating the cable lug connection
- Excellent resistance to vibration
- No crimping

AESTHETICS

- Optimal flexibility for easy access

EASY INSTALLATION

- Thanks to its design all Flexibar can be easily bent and shaped for all sizes

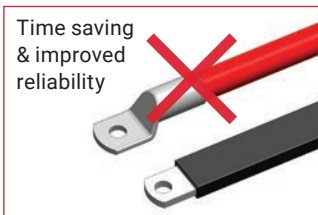
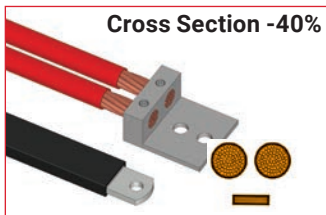
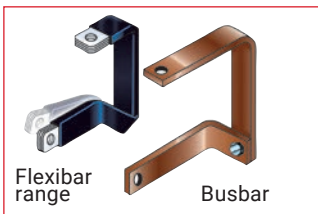
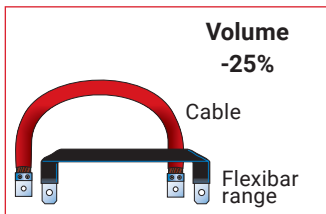

SKIN EFFECT ON A.C. APPLICATION

Comparison to the penetration depth between:

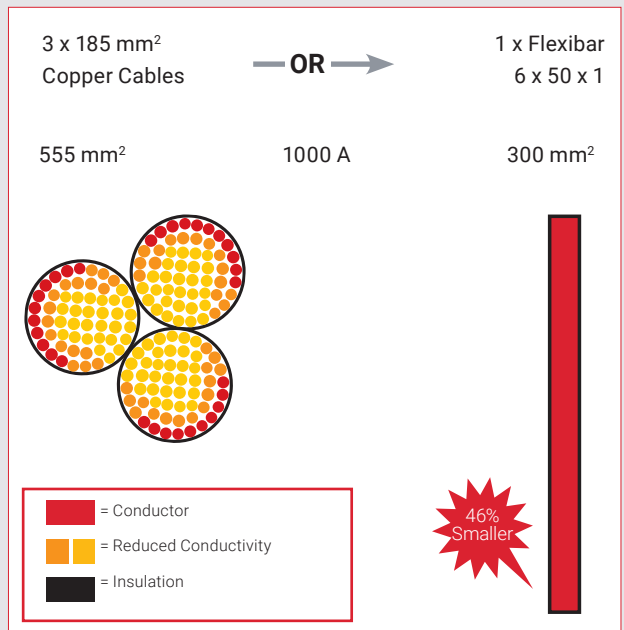
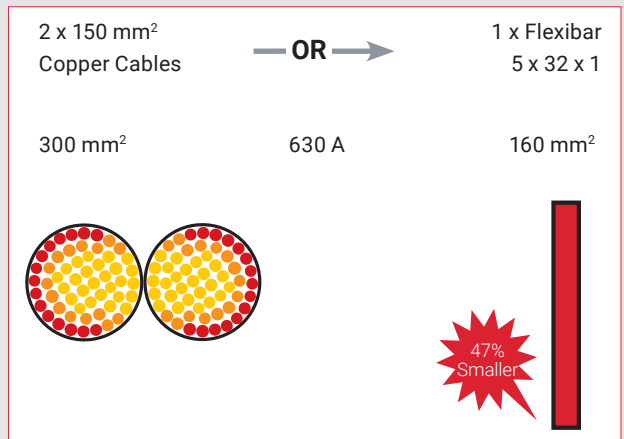
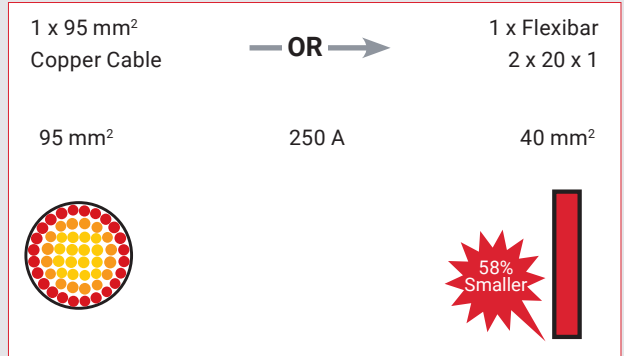

Representative to scale

Flexibar intensity and cable intensity are based on conductor temperature rise of 50°C

nVent ERIFLEX Flexibar Advanced

UNIQUE - SAFER - FLEXIBLE



FLEXIBAR ADVANCED

UNIQUE – SAFER – FLEXIBLE

- Conductor is electrolytic tinned copper (Cu-ETP)
- Insulation is a high-resistance TEP Low Smoke, Halogen Free and Flame Retardant (LSHFFR), compound:
 - Typical elongation: 500%
 - Working temperature: –50°C to 115°C
 - Typical thickness: 1,8 mm
 - Self-extinguishing:
UL 94-V0 and IEC 60695-2-11 (Glow Wire Test 960°C)
 - Dielectric strength: 20kV/mm
 - Nominal voltage: 1000 V AC/1500 V DC (IEC - UL - CSA)
 - Dielectric strength: 20kV/mm

Flexibar Advanced has a unique insulation on the market that combine low smoke, halogen-free and flame retardant features that improve both the reliability of your electrical installation and safety for equipment and people.

WHY IS FLEXIBAR ADVANCED A SAFER INSULATION?

Low smoke features:

- Generates less corrosive smoke as per IEC 61034-2, ISO 5659-2 and UL 2885
- Improves visibility for people to be able to easily locate the emergency exit and also allows rescue workers to better assess an emergency situation

Halogen-free features:





- Reduction in the quantity of toxic smoke
- Minimum of toxicity with no halogens (according to UL 2885, IEC 60754-1 and IEC 62821-1)
- Use in enclosed spaces for specific applications such as submarines, switchboards, and other enclosed environments that require a low emissions solution

Flame-retardant and Self-extinguishing features:

- Compliant with the UL 94-V0 and Glow wire test at 960°C (IEC 60695-2) testing standard
- Reduces the risk of the spread of fire
- Less damage to your electrical installation



FLEXIBAR ADVANCED TINNED COPPER TECHNICAL CHARACTERISTICS

A	Part Number					Section mm ²	ΔT (K)						Current Coefficient			
		N	A mm	x	B mm		x	mm ²	70	60	50	40	30	20		
									70	60	50	40	30	20		
125 A	534001	3	x 9	x 0,8	21,6	158	147	134	120	104	85	1,72	2,25			
	534000	8	x 6	x 0,5	24	196	182	166	143	128	105	1,72	2,25			
	534004	3	x 13	x 0,5	19,5	198	184	167	150	130	106	1,72	2,25			
	534006	2	x 15,5	x 0,8	24,8	252	234	212	191	165	134	1,72	2,25			
	534002	6	x 9	x 0,8	43,2	290	269	245	220	190	155	1,72	2,25			
250 A	534005	6	x 13	x 0,5	39	300	277	253	226	196	160	1,72	2,25			
	534003	9	x 9	x 0,8	64,8	314	291	265	237	206	168	1,72	2,25			
	534010	2	x 20	x 1	40	326	300	275	246	214	174	1,72	2,25			
	534007	4	x 15,5	x 0,8	49,6	380	350	320	286	248	202	1,72	2,25			
	534011	3	x 20	x 1	60	428	395	360	323	280	228	1,72	2,25			
534016	2	x 24	x 1	48	450	416	380	340	295	240	1,72	2,25				
400 A	534008	6	x 15,5	x 0,8	74,4	476	440	402	360	318	254	1,72	2,25			
	534012	4	x 20	x 1	80	476	440	402	360	312	254	1,72	2,25			
	534023	2	x 32	x 1	64	480	445	406	363	315	257	1,72	2,25			
	534017	3	x 24	x 1	72	490	453	413	370	320	261	1,72	2,25			
	534013	5	x 20	x 1	100	498	460	420	376	326	266	1,72	2,25			
	534009	10	x 15,5	x 0,8	124	538	498	455	407	352	288	1,72	2,25			
	534030	2	x 40	x 1	80	538	500	455	406	352	288	1,72	2,25			
	534014	6	x 20	x 1	120	546	506	462	413	358	292	1,72	2,25			
	534018	4	x 24	x 1	96	550	510	465	416	360	294	1,72	2,25			
534024	3	x 32	x 1	96	570	525	480	430	372	304	1,72	2,25				
500 A	534019	5	x 24	x 1	120	608	563	514	460	398	325	1,72	2,25			
	534031	3	x 40	x 1	120	617	570	522	466	405	330	1,72	2,25			
	534025	4	x 32	x 1	128	648	600	548	490	425	347	1,72	2,25			
	534020	6	x 24	x 1	144	670	620	566	506	438	358	1,72	2,25			
	534037	3	x 50	x 1	150	700	650	592	530	460	374	1,72	2,25			
	534032	4	x 40	x 1	160	727	673	615	550	476	389	1,72	2,25			
630 A	534026	5	x 32	x 1	160	758	702	640	573	496	405	1,72	2,25			
	534015	10	x 20	x 1	200	762	706	645	576	500	408	1,72	2,25			
	534021	8	x 24	x 1	192	802	743	678	606	525	429	1,72	2,25			
	534027	6	x 32	x 1	192	846	783	715	640	555	452	1,72	2,25			
	534038	4	x 50	x 1	200	860	795	727	650	563	460	1,72	2,25			
	534033	5	x 40	x 1	200	900	832	760	680	590	481	1,72	2,25			
800 A	534022	10	x 24	x 1	240	948	877	800	716	592	506	1,72	2,25			
	534044	4	x 63	x 1	252	1010	935	855	763	661	541	1,65	2,12			
	534028	8	x 32	x 1	256	1018	943	860	770	667	544	1,72	2,25			
	534034	6	x 40	x 1	240	1018	943	860	770	667	544	1,72	2,25			
	534039	5	x 50	x 1	250	1100	1016	930	830	718	588	1,72	2,25			
1000 A	534049	4	x 80	x 1	320	1200	1110	1015	906	785	642	1,65	2,12			
	534045	5	x 63	x 1	315	1220	1125	1030	920	797	651	1,65	2,12			
	534040	6	x 50	x 1	300	1225	1135	1035	925	802	655	1,72	2,25			
	534029	10	x 32	x 1	320	1230	1140	1040	930	805	658	1,72	2,25			
	534035	8	x 40	x 1	320	1230	1140	1040	930	805	658	1,72	2,25			
	534041	8	x 50	x 1	400	1393	1290	1175	1050	912	743	1,72	2,25			
	534050	5	x 80	x 1	400	1390	1285	1175	1050	910	743	1,65	2,12			
	534036	10	x 40	x 1	400	1400	1295	1181	1055	915	747	1,72	2,25			
534046	6	x 63	x 1	378	1437	1330	1215	1085	941	768	1,65	2,12				
1250 A	534051	6	x 80	x 1	480	1627	1505	1375	1230	1065	870	1,65	2,12			
	534055	5	x 100	x 1	500	1635	1515	1385	1235	1070	876	1,6	2,02			
	534042	10	x 50	x 1	500	1650	1525	1395	1245	1080	882	1,72	2,25			
	534047	8	x 63	x 1	504	1650	1525	1395	1245	1080	882	1,65	2,12			
	534056	6	x 100	x 1	600	1843	1705	1550	1393	1205	980	1,6	2,02			
1600 A	534048	10	x 63	x 1	630	1895	1755	1600	1435	1240	1012	1,65	2,12			
	534052	8	x 80	x 1	640	1895	1755	1600	1430	1240	1012	1,65	2,12			
	534053	10	x 80	x 1	800	2100	1945	1775	1585	1375	1123	1,65	2,12			
	534057	8	x 100	x 1	800	2147	1990	1815	1625	1405	1148	1,6	2,02			
	534058	10	x 100	x 1	1000	2350	2170	1985	1775	1535	1255	1,6	2,02			
	534059	12	x 100	x 1	1200	2500	2315	2115	1890	1636	1338	1,6	2,02			
	534060	10	x 120	x 1	1200	2755	2550	2330	2070	1792	1474	1,49	1,95			

ADMISSIBLE CURRENTS: This table indicates the temperature rise produced by chosen current in the given section. This calculation does not take into account the heat dissipation from the switch gear.

nVent ERIFLEX Flexibar Advanced

UNIQUE - SAFER - FLEXIBLE

Selection of Flexibar Advanced according to the internal temperature of the panel

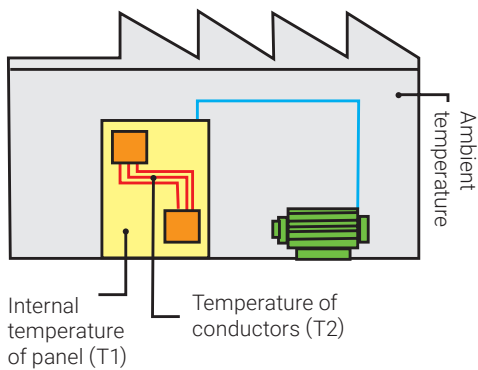

TEMPERATURE RISE OF CONDUCTOR = $T_2 - T_1 = \Delta T$ (K)

Ex: For a current of 630A, with: $T_1 = 40^\circ\text{C}$ and $T_2 = 90^\circ\text{C}$

1) $\Delta T = 90 - 40 = 50\text{K}$

2) In the 50°K column, find the closest current value to 630A.
Flexibar Advanced 5x32x1 - 552650 - 160 mm² - 640A.

3) Select Flexibar Advanced according to the terminal width of the equipment being connected.

K = Kelvin degree (temperature calculated, but not measurable)

FLEXIBAR ADVANCED IN PARALLEL

When using 2 or 3 Flexibar Advanced on edge in parallel for the same phase, use the coefficient:

Ex: $5 \times 32 \times 1$: $\Delta T^\circ = 50\text{K}$: 640 A

2 bars in parallel : $640\text{ A} \times 1,72 = 1100\text{ A}$

3 bars in parallel : $640\text{ A} \times 2,25 = 1440\text{ A}$



CERTIFICATION & APPROVALS

- International Commission Electrotechnique (IEC) - Meets all requirements of IEC 61439.1
- UL 67 Recognized component in the Panelboard and Switchboard accessories – component category (UL file E125470) for US
- UL 758 Recognized component in the “Appliance wiring material - component” category style 11681
- CSA 90005
- CE Conformity
- RoHS compliant
- Class II Conductors (IEC 61439-1, Chapter 8.4.4 - Protection by total insulation)
- Low Smoke IEC 61034-2, ISO 5659-2 and UL 2885
- Halogen-free UL 2885, IEC 60754-1 and IEC 62821-1
- Flame retardant UL94-V0
- Glow wire test at 960°C (IEC 60695-2)
- UV rating according to UL 2556 and UL 854
- EN 45545 obtaining an HL2 classification for chapters R22 and R23
- EN 50264-3-1 (Railway application) : 6kV AC/DC
- Bureau Veritas Marine and Offshore Division - for the Classification of Steel Ships and according IEC 60092 (Electrical installations on ships)
- American Bureau of Shipping (ABS) - Marine & Offshore Applications



nVent ERIFLEX Flexibar Advanced Part Numbers

2 METERS TINNED COPPER

Part Number	Global Part Number	Flexibar Description		 Kg
534000	FADV2MTC8X6	Flexibar Advanced 2 m Tinned Copper 8X6X0,5	4	0,35
534001	FADV2MTC3X9	Flexibar Advanced 2 m Tinned Copper 3X9X0,8	4	0,43
534002	FADV2MTC6X9	Flexibar Advanced 2 m Tinned Copper 6X9X0,8	4	0,81
534003	FADV2MTC9X9	Flexibar Advanced 2 m Tinned Copper 9X9X0,8	4	1,19
534004	FADV2MTC3X13	Flexibar Advanced 2 m Tinned Copper 3X13X0,5	4	0,45
534005	FADV2MTC6X13	Flexibar Advanced 2 m Tinned Copper 6X13X0,5	4	0,79
534006	FADV2MTC2X15-5	Flexibar Advanced 2 m Tinned Copper 2X15,5X0,8	4	0,51
534007	FADV2MTC4X15-5	Flexibar Advanced 2 m Tinned Copper 4X15,5X0,8	4	1,02
534008	FADV2MTC6X15-5	Flexibar Advanced 2 m Tinned Copper 6X15,5X0,8	4	1,50
534009	FADV2MTC10X15-5	Flexibar Advanced 2 m Tinned Copper 10X15,5X0,8	4	2,20
534010	FADV2MTC2X20X1	Flexibar Advanced 2 m Tinned Copper 2X20X1	3	1,05
534011	FADV2MTC3X20X1	Flexibar Advanced 2 m Tinned Copper 3X20X1	3	1,42
534012	FADV2MTC4X20X1	Flexibar Advanced 2 m Tinned Copper 4X20X1	3	1,78
534013*	FADV2MTC5X20X1	Flexibar Advanced 2 m Tinned Copper 5X20X1	3	2,15
534014*	FADV2MTC6X20X1	Flexibar Advanced 2 m Tinned Copper 6X20X1	3	2,41
534015*	FADV2MTC10X20X1	Flexibar Advanced 2 m Tinned Copper 10X20X1	3	3,99
534016	FADV2MTC2X24X1	Flexibar Advanced 2 m Tinned Copper 2X24X1	3	1,24
534017	FADV2MTC3X24X1	Flexibar Advanced 2 m Tinned Copper 3X24X1	3	1,68
534018	FADV2MTC4X24X1	Flexibar Advanced 2 m Tinned Copper 4X24X1	3	2,12
534019*	FADV2MTC5X24X1	Flexibar Advanced 2 m Tinned Copper 5X24X1	3	2,55
534020*	FADV2MTC6X24X1	Flexibar Advanced 2 m Tinned Copper 6X24X1	3	2,99
534021*	FADV2MTC8X24X1	Flexibar Advanced 2 m Tinned Copper 8X24X1	3	3,87
534022*	FADV2MTC10X24X1	Flexibar Advanced 2 m Tinned Copper 10X24X1	3	4,75
534023	FADV2MTC2X32X1	Flexibar Advanced 2 m Tinned Copper 2X32X1	2	1,62
534024	FADV2MTC3X32X1	Flexibar Advanced 2 m Tinned Copper 3X32X1	2	2,20
534025	FADV2MTC4X32X1	Flexibar Advanced 2 m Tinned Copper 4X32X1	2	2,78
534026*	FADV2MTC5X32X1	Flexibar Advanced 2 m Tinned Copper 5X32X1	2	3,36
534027*	FADV2MTC6X32X1	Flexibar Advanced 2 m Tinned Copper 6X32X1	2	3,94
534028*	FADV2MTC8X32X1	Flexibar Advanced 2 m Tinned Copper 8X32X1	2	5,10
534029*	FADV2MTC10X32X1	Flexibar Advanced 2 m Tinned Copper 10X32X1	2	6,27
534030	FADV2MTC2X40X1	Flexibar Advanced 2 m Tinned Copper 2X40X1	2	1,99
534031	FADV2MTC3X40X1	Flexibar Advanced 2 m Tinned Copper 3X40X1	2	2,72
534032	FADV2MTC4X40X1	Flexibar Advanced 2 m Tinned Copper 4X40X1	2	3,44
534033*	FADV2MTC5X40X1	Flexibar Advanced 2 m Tinned Copper 5X40X1	2	4,16
534034*	FADV2MTC6X40X1	Flexibar Advanced 2 m Tinned Copper 6X40X1	2	4,89
534035*	FADV2MTC8X40X1	Flexibar Advanced 2 m Tinned Copper 8X40X1	2	6,33
534036*	FADV2MTC10X40X1	Flexibar Advanced 2 m Tinned Copper 10X40X1	2	7,78
534037	FADV2MTC3X50X1	Flexibar Advanced 2 m Tinned Copper 3X50X1	1	3,37
534038*	FADV2MTC4X50X1	Flexibar Advanced 2 m Tinned Copper 4X50X1	1	4,27
534039*	FADV2MTC5X50X1	Flexibar Advanced 2 m Tinned Copper 5X50X1	1	5,17
534040*	FADV2MTC6X50X1	Flexibar Advanced 2 m Tinned Copper 6X50X1	1	6,07
534041*	FADV2MTC8X50X1	Flexibar Advanced 2 m Tinned Copper 8X50X1	1	7,87
534042*	FADV2MTC10X50X1	Flexibar Advanced 2 m Tinned Copper 10X50X1	1	9,68
534044*	FADV2MTC4X63X1	Flexibar Advanced 2 m Tinned Copper 4X63X1	1	5,34
534045*	FADV2MTC5X63X1	Flexibar Advanced 2 m Tinned Copper 5X63X1	1	6,48
534046*	FADV2MTC6X63X1	Flexibar Advanced 2 m Tinned Copper 6X63X1	1	7,61
534047*	FADV2MTC8X63X1	Flexibar Advanced 2 m Tinned Copper 8X63X1	1	9,88
534048*	FADV2MTC10X63X1	Flexibar Advanced 2 m Tinned Copper 10X63X1	1	12,14
534049*	FADV2MTC4X80X1	Flexibar Advanced 2 m Tinned Copper 4X80X1	1	6,75
534050*	FADV2MTC5X80X1	Flexibar Advanced 2 m Tinned Copper 5X80X1	1	8,19
534051*	FADV2MTC6X80X1	Flexibar Advanced 2 m Tinned Copper 6X80X1	1	9,62
534052*	FADV2MTC8X80X1	Flexibar Advanced 2 m Tinned Copper 8X80X1	1	12,49
534053*	FADV2MTC10X80X1	Flexibar Advanced 2 m Tinned Copper 10X80X1	1	15,37
534055*	FADV2MTC5X100X1	Flexibar Advanced 2 m Tinned Copper 5X100X1	1	10,20
534056*	FADV2MTC6X100X1	Flexibar Advanced 2 m Tinned Copper 6X100X1	1	11,99
534057*	FADV2MTC8X100X1	Flexibar Advanced 2 m Tinned Copper 8X100X1	1	15,57
534058*	FADV2MTC10X100	Flexibar Advanced 2 m Tinned Copper 10X100X1	1	19,16
534059*	FADV2MTC12X100	Flexibar Advanced 2 m Tinned Copper 12X100X1	1	22,74
534060*	FADV2MTC10X120	Flexibar Advanced 2 m Tinned Copper 10X120X1	1	22,90



All Flexibar Advanced cross sections can be bent, folded or twisted with a small bending radius for shorter and more compact power connections, from 125A up to 4500A applications.



*nVent ERIFLEX Patent insulation

nVent ERIFLEX Flexibar Advanced Part Numbers

3 METERS TINNED COPPER

Typical Application Current Rating	Part Number	Article Number	Flexibar Description		 Kg
250	FADV3MTC2X20X1	534110	nVent ERIFLEX Flexibar Advanced, 3M Tinned Copper 2X20X1	5	1,58
	FADV3MTC3X20X1	534111	nVent ERIFLEX Flexibar Advanced, 3M Tinned Copper 3X20X1	5	2,13
	FADV3MTC2X24X1	534116	nVent ERIFLEX Flexibar Advanced, 3M Tinned Copper 2X24X1	5	1,86
400	FADV3MTC4X20X1	534112	nVent ERIFLEX Flexibar Advanced, 3M Tinned Copper 4X20X1	5	2,67
	FADV3MTC5X20X1	534113	nVent ERIFLEX Flexibar Advanced, 3M Tinned Copper 5X20X1	5	3,23
	FADV3MTC6X20X1	534114	nVent ERIFLEX Flexibar Advanced, 3M Tinned Copper 6X20X1	5	3,62
	FADV3MTC3X24X1	534117	nVent ERIFLEX Flexibar Advanced, 3M Tinned Copper 3X24X1	5	2,52
	FADV3MTC4X24X1	534118	nVent ERIFLEX Flexibar Advanced, 3M Tinned Copper 4X24X1	5	3,18
	FADV3MTC2X32X1	534123	nVent ERIFLEX Flexibar Advanced, 3M Tinned Copper 2X32X1	2	2,43
	FADV3MTC3X32X1	534124	nVent ERIFLEX Flexibar Advanced, 3M Tinned Copper 3X32X1	2	3,30
500	FADV3MTC5X24X1	534119	nVent ERIFLEX Flexibar Advanced, 3M Tinned Copper 5X24X1	5	3,83
	FADV3MTC6X24X1	534120	nVent ERIFLEX Flexibar Advanced, 3M Tinned Copper 6X24X1	5	4,49
	FADV3MTC4X32X1	534125	nVent ERIFLEX Flexibar Advanced, 3M Tinned Copper 4X32X1	2	4,17
	FADV3MTC3X40X1	534131	nVent ERIFLEX Flexibar Advanced, 3M Tinned Copper 3X40X1	2	4,08
	FADV3MTC3X50X1	534137	nVent ERIFLEX Flexibar Advanced, 3M Tinned Copper 3X50X1	2	5,06
630	FADV3MTC5X32X1	534126	nVent ERIFLEX Flexibar Advanced, 3M Tinned Copper 5X32X1	2	5,04
	FADV3MTC6X32X1	534127	nVent ERIFLEX Flexibar Advanced, 3M Tinned Copper 6X32X1	2	5,91
	FADV3MTC4X50X1	534138	nVent ERIFLEX Flexibar Advanced, 3M Tinned Copper 4X50X1	2	6,41
800	FADV3MTC8X32X1	534128	nVent ERIFLEX Flexibar Advanced, 3M Tinned Copper 8X32X1	2	7,65
	FADV3MTC6X40X1	534134	nVent ERIFLEX Flexibar Advanced, 3M Tinned Copper 6X40X1	2	7,34
	FADV3MTC5X50X1	534139	nVent ERIFLEX Flexibar Advanced, 3M Tinned Copper 5X50X1	2	7,76



Accessories

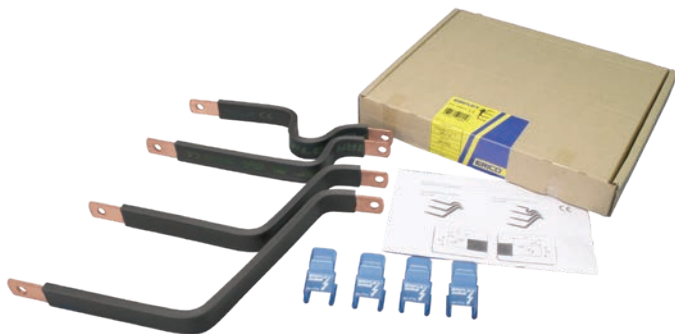

FLEXIBAR STANDARD KITS

- Application: connections between busbar and fixed switchgear
- Kit is comprised of Flexibar Standard preformed and punched at the 2 extremities & end covers
- Only 1 kit for 3 configuration options
- Intensity range: from 250A to 630A



END COVER 20, 24 & 32

- End Cover 20: Accessory for nVent ERIFLEX Flexibar 20 mm, Kit 250T and TN, IBS Adv 25, IBS Adv 50, IBSB Adv 50 and IBSB Adv 70
- End Cover 24: Accessory for nVent ERIFLEX Flexibar 24 mm and IBSB Adv 100
- End Cover 32: Accessory for nVent ERIFLEX Flexibar 32 mm, Kit 630A T and TN, IBSB Adv 120, 185 and 240.
- Transparent cover Visual inspection
- Halogen-free
- Self-extinguishing: UL 94 V-0
- RoHS compliant
- Easy-fitting after bolting
- IEC 61439-1

FLEXIBAR STANDARD KIT 250A

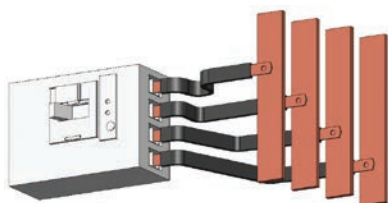

3 Phases

3 Phases +
Neutral

Kit 250A T

Kit 250A TN

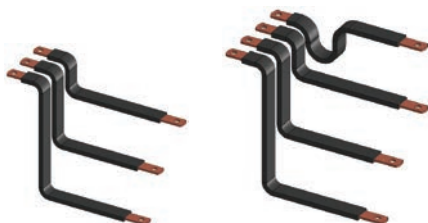

Part No.	Description		kg/lbs
534800	Kit 250A T Advanced	1	0,76/1.68
534805	Kit 250A TN Advanced	1	0,98/2.16

FLEXIBAR STANDARD KIT 630A

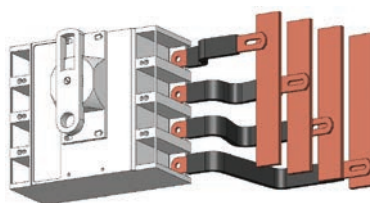

3 Phases

3 Phases +
Neutral

Kit 630A T

Kit 630A TN

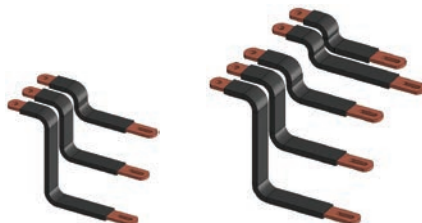

Part No.	Description		kg/lbs
534810	Kit 630A T Advanced	1	2,10/4.63
534815	Kit 630A TN Advanced	1	3,10/6.83

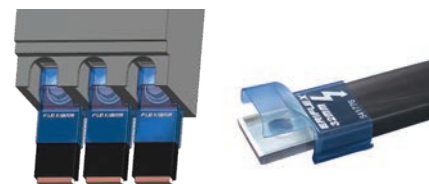

Part No.	Description		kg/lbs
541774	End Cover 20	12	0,19/0.42
541775	End Cover 24	12	0,22/0.48
541776	End Cover 32	12	0,26/0.57

Accessories

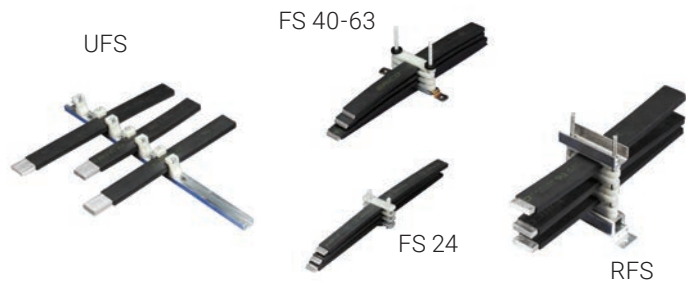

SPACER CLAMPS

- Easy to install
- Fixes and maintains the weight of Flexibar range
- Facilitates cooling

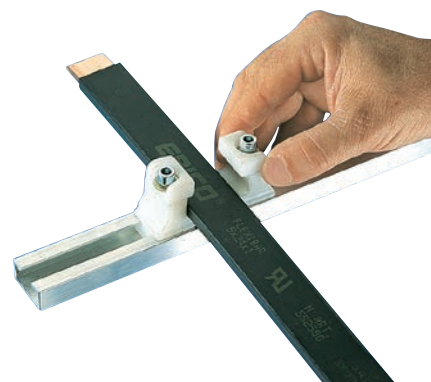

UFS KIT SUPPORT

Assembly comprised of a 2 m aluminum section and 24 retaining blocks made of glass-reinforced halogen-free polyamide

- Possible to make up 3 supports, 650 mm long each for 4 Flexibar range
- Recommended distance between clamps: 400 mm max for Flexibar and 630 mm Max for IBS/IBSB Advanced

FS SPACER CLAMP

- Ensures correct support for Flexibar range and IBSB Advanced in parallel, without damage to the insulation
- Maintains correct space for optimum cooling
- 4 Flexibar range in parallel maximum
- UL 67
- Recommended distance between clamps: 400 mm for Flexibar and 630 mm Max for IBS/IBSB Advanced

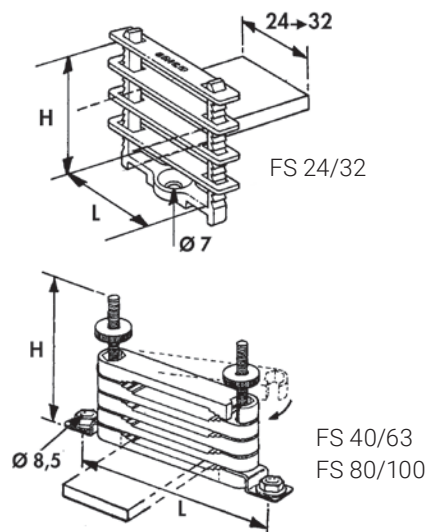

Part No.	Description	Type*	H mm	L mm		Kg
553550	FS 24	=< 24 mm	67	30	25	0,015
553560	FS 32	=< 32 mm	67	38	25	0,018
553570	FS 40-63	40-50 & 63 mm	95	150	10	0,100
553580	FS 80-100	80/100 mm	140	200	10	0,250

* Type of Flexibar and IBS/IBSB Advanced

RFS REINFORCED SUPPORT

- Allows up to 8 Flexibar range in parallel.
- Easy mounting in the panel. (25 mm pitch)
- Recommended distance between clamps: 400 mm

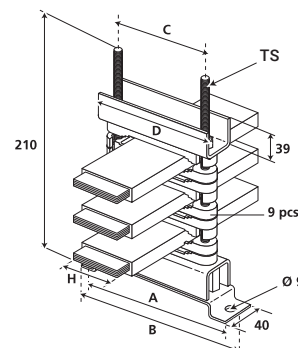
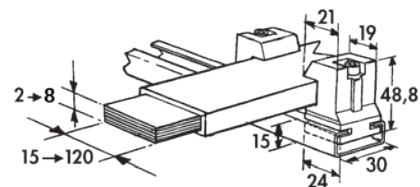

Part No.	Description		Kg
553590	UFS Kit	1	2,3

Part No.	Description	A mm	B mm	C mm	D mm	TS	Flexibar H mm		Kg
553370	RFS 40-63	150	175	90	120	M8	40=>63	1	0,932
553380	RFS 80-100	200	225	140	170	M10	80=>100	1	1,430

Accessories

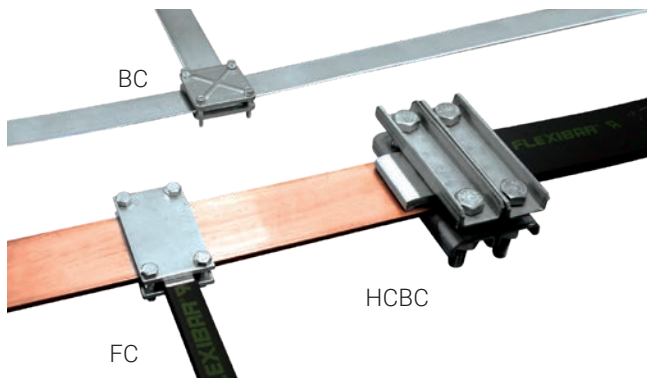

CONNECTING CLAMPS

- Excellent electrical contact
- Saves space
- Fast installation
- Ideal for on site modifications

FC CLAMP

- Clamping capacity: 20 mm
- 2 zinc plated steel plates complete with M8 screws 8.8 class

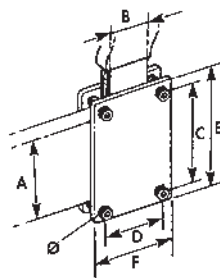

Part No.	Description	A mm	B mm	C mm	D mm	E mm	F mm	Torque N.m	Box	Kg
553020	FC 50 x 24	50	20-24	60	36	75	52	10	3	0,319
553030	FC 50 x 32	50	32	60	44	75	60	10	3	0,362
553040	FC 50 x 40	50	40	60	52	75	68	10	3	0,412
553050	FC 80 x 24	80	20-24	90	36	105	52	10	3	0,432
553060	FC 80 x 32	80	32	90	44	105	60	10	3	0,492
553070	FC 80 x 50	80	50	90	62	105	78	10	3	0,642
568700	FC 100 x 32	100	32	110	44	125	60	10	3	0,670
568730	FC 120 x 32	120	32	130	44	145	60	10	3	0,760

BC RIBBED-STEEL BUSBAR CLAMP

- Clamping capacity: 20 mm
- 2 ribbed zinc-plated hardened-steel plates complete with screws
- Maximum clamping capacity is 50 mm using longer screws 8.8 class
- UL 67 recognized

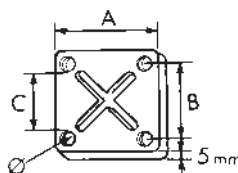

Part No.	Description	A mm	B mm	C mm	Ø mm	Torque N.m	Box	Kg
553200	BC 30	56	42	30	M6	7	8	0,31
553210	BC 40	66	52	40	M6	7	8	0,37
553220	BC 50	83	64	50	M8	20	8	0,59
553230	BC 63	93	74	63	M8	20	4	0,74
553250	BC 80	118	96	80	M10	40	4	0,118
553260	BC 100	144	118	100	M10	40	4	1,72

HCBC HIGH CURRENT BUSBAR CLAMP

- Clamping capacity: 40 mm
- This modular busbar clamp is designed with non-magnetic materials for high current connections between Flexibar range and rigid busbars such as transformer terminals
- Design assures rigidity and even contact pressure
- Use 2 clamps to guarantee the contact pressure

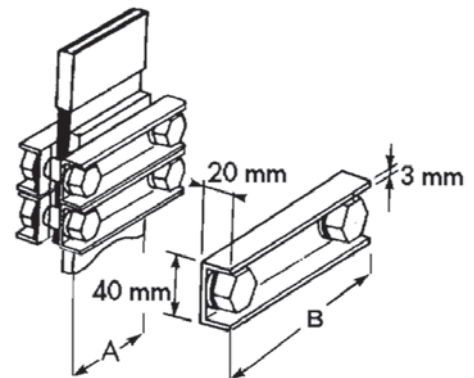

Part No.	Description	A mm	B mm	Torque N.m	Box	Kg
553100	HSBC 80	80	140	100	1	0,84
553110	HSBC 100	100	160	100	1	0,92
553120	HSBC 120	120	180	100	1	1,00

Accessories



FBC CONNECTORS FOR CONNECTING WITHOUT DRILLING

- Very compact for connection without drilling to a 5 mm or 10 mm thick busbar
- Cables from 1 mm² up to 185 mm² or Flexibar range width 6 mm to 20 mm
- Self-support of connector during mounting procedure
- IEC 60 999

Part No.	Description	A mm	B mm	C mm	Flexibar Type mm	Torque N.m	Cable Size mm ²		Kg
553405	FBC 5 x 4	23	29	11	-	2	1 - 4	15	0,016
553400	FBC 5 x 6	28	31	14	6	3	2,5 - 16	15	0,028
553410	FBC 5 x 9	36	40	19	9	6-8	16 - 50	15	0,068
553510	FBC 5 x 15,5	44	40	25	15,5	10-12	35 - 70	15	0,110
553520	FBC 5 x 20	48	40	31	20	12-15	70 - 185	15	0,132

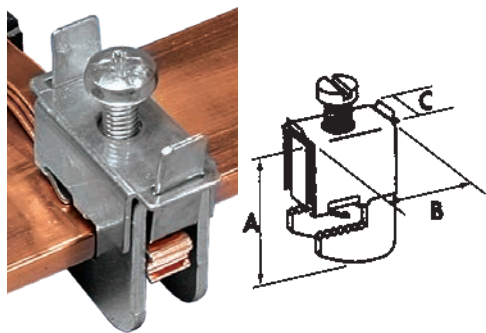

Part No.	Description	A mm	B mm	C mm	Flexibar Type mm	Torque N.m	Cable Size mm ²		Kg
553505	FBC 10 x 4	28	29	12	-	2	1 - 4	15	0,018
553430	FBC 10 x 6	33	31	14	6	3	2,5 - 16	15	0,030
553440	FBC 10 x 9	42	40	19	9	6 - 8	16 - 50	15	0,070
553530	FBC 10 x 15,5	49	40	25	15,5	10 - 12	35 - 70	15	0,112
553540	FBC 10 x 20	54	40	31	20	12 - 15	70 - 185	15	0,138

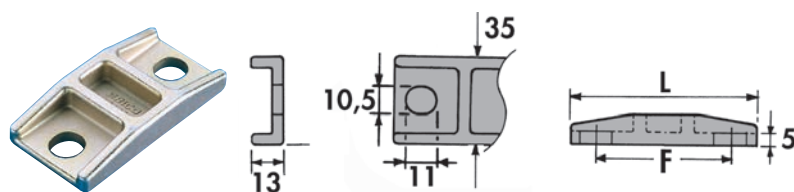

QCC CLAMPS

- For Flexibar thickness < 5 mm = 1 clamp
- For Flexibar thickness > 5 mm = 2 clamps

Part No.	Description	Flexibar width		L mm	F mm		Kg
		min. mm	max. mm				
561210	QCC 15,5/32	15,5	32	70	50	5	0,112
561220	QCC 40/63	40	63	95	75	5	0,158



CONT KIT METAL NUTS AND BOLTS

- Contact Kit
- Enhanced electrical contact
 - 100 nuts - 100 bolts - 200 flat washers
 - 200 contact washers (class 8/8 ZN8C protection)

Part No.	Description	Dimensions	Torque N.m		Kg
558310	Cont Kit M6 x 16	HM 6 x 16	13	100	0,012
558340	Cont Kit M8 x 30	HM 8 x 30	30	100	0,028
558370	Cont Kit M10 x 30	HM 10 x 30	60	100	0,052
558410	Cont Kit M10 x 50	HM 10 x 50	60	100	0,062
558440	Cont Kit M12 x 30	HM 12 x 30	110	100	0,081
558460	Cont Kit M12 x 40	HM 12 x 40	110	100	0,091
558480	Cont Kit M12 x 50	HM 12 x 50	110	100	0,097
567880	Cont Kit M12 x 60	HM 12 x 60	110	100	0,116
558490	Cont Kit M12 x 80	HM 12 x 80	110	100	0,150

nVent ERIFLEX Flexibar Hydraulic Work Center



To discover our full range of tools, please request our Hydraulic & Manual Tools brochure



Hydraulic Busbar & Flexibar Puncher

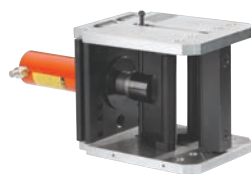

Hydraulic Busbar Bender



Hydraulic Busbar Cutter



Shearing Tool Ruler



Hydraulic Pump & Foot Controller



Hydraulic Flexibar Shearing Tool



Shearing Tool Guide

nVent ERIFLEX Flexibar Manual Work Center

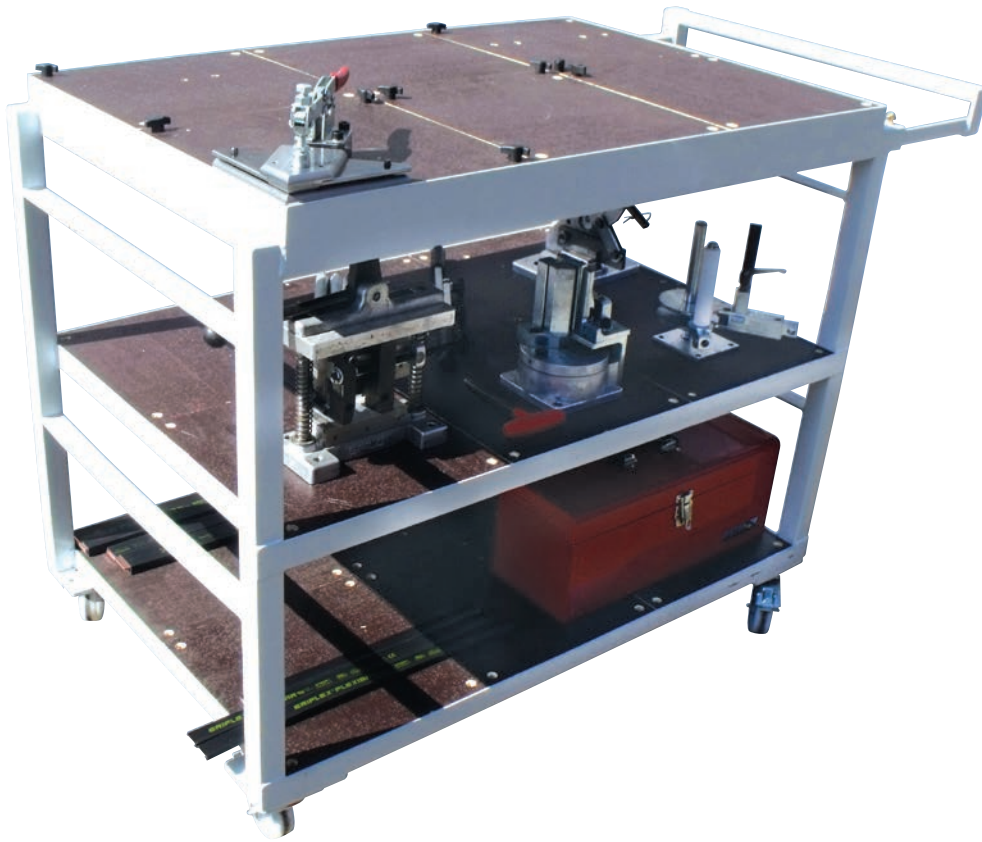

Shearing Tools



Twisting Tool



Bending Tools



Drilling Tool



Punching Tools



Folding Tool



Stripping Tool



Stripping Knife



Bending Tool

Flat Insulated Braided Conductor IBS/IBSB Advanced

HALOGEN-FREE - LOW SMOKE - FLAME RETARDANT INSULATED BRAIDED CONDUCTOR FOR CIRCUIT BREAKERS



SPACE AND WEIGHT ADVANTAGE

- nVent ERIFLEX IBS & IBSB Advanced require less wire bending space than traditional cable with greater flexibility
- With greater ampacities, a single piece of IBS & IBSB Advanced can replace multiple runs of cable
- Protective sleeve and flexibility allows IBS & IBSB Advanced to be mounted in tight areas where rigid busbar or rigid cables can not be used
- No clearance distance needed around IBS & IBSB Advanced vs other phases or metallic parts due to Class II insulation characteristics
- Integral solid palm without lugs or terminals reduces material and assembly weight

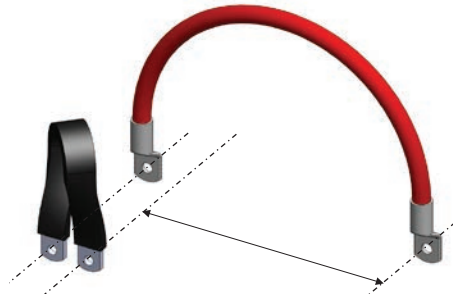

TIME ADVANTAGE

- IBS & IBSB Advanced is a ready to use conductor that does not require lug or tools to fabricate the conductor, reducing installation time and cost
- Easier to bend and shape than large cables, making installation quicker



AESTHETIC ADVANTAGE

- Increases design flexibility
- Neatly organizes hard-to-make connections

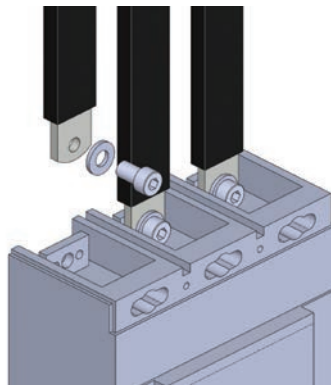

RELIABILITY & SAFETY ADVANTAGE

- IBS & IBSB Advanced are directly connected thus eliminating the cable lug connection and other source of heating point
- IBS & IBSB Advanced have tinned protected palms for better corrosion resistance
- Excellent resistance to vibration.
- No crimping
- Less human error
- Insulation sleeve manufactured from high-resistance low smoke, halogen-free and flame retardant Thermoplastic (LSHFFR), with a 115°C maximum temperature



OPERATING ADVANTAGE

- IBS & IBSB Advanced are able to connect on the front access connection of the main molded case circuit breakers
- Ring terminals or lugs are no longer needed as IBS & IBSB Advanced is already punched. No additional crimping operation is needed
- The high working temperature 115°C is better than a standard cable that allow reducing the risk of hot point at the connecting area





nVent ERIFLEX Advanced Technology insulation is a high-resistance low smoke, halogen-free and flame retardant Thermoplastic (LSHFFR), with 115°C high working temperature.

IBS & IBSB Advanced does not generate corrosive gases and produces a relatively **low smoke** opacity in accordance with IEC 61034-2 and UL 2885. The low smoke features improves visibility conditions for people to be able to easily locate the emergency exit and also allows rescue workers to better assess an emergency situation. IBS & IBSB Advanced means greater safety for individuals, less damage for your electrical equipment and less environmental impact.

The **halogen-free** feature enables a reduction in the quantity of toxic smoke. IBS & IBSB Advanced contain no halogens, according to IEC 60754-1 and UL 2885, minimizing toxicity and making it the ideal product for use in enclosed spaces such as data centers, rail and spaces where people are present such as hospitals and schools. This feature also facilitates the use of IBS & IBSB Advanced in specific applications such as submarines, switchboards and other enclosed environments that require a low emissions solution.

In addition to the above features, IBS & IBSB Advanced are compliant with the UL 94-V0 testing standard and Glow wire test 960°C. The **flame retardant** portion of the test illustrates self-extinguishing capabilities. This feature is also shown by the Limiting Oxygen Index (LOI) at 30%. In the case of a fire, IBS & IBSB Advanced generates a limited quantity of smoke that is less damaging to your electrical equipment.









Main Technical Specifications

Flat IBS and IBSB Advanced	
Material	Electrolytic copper Cu-ETP 99,9% purity Thermoplastic Elastomer
Wire Diameter	0,15 mm
Finish	Tinned
Maximum resistivity at 20°C	0.017241 ohms.mm2 / m
Dielectric Strength	20 kV/mm
Flammability Rating	UL® 94V-0 IEC® 60695-2-12 (Glow Wire Test 960 °C)
Halogen Free Rating	UL® 2885 IEC® 60754-1 IEC® 62821-2
Low Smoke Rating	UL® 2885 IEC® 61034-2 ISO 5659-2
Typical Insulation Elongation	> 500%
Typical Insulation Thickness	1,8 mm (0,070 inches)
Nominal Voltage	UL/IEC: 1,000 VAC; 1,500 VDC
Working Temperature	-50 to 115 °C (-58 to 239°F)
Certification Details	UL® 67 UL® 758 CSA 90005
Complies With	IEC® 60695-2-12 (Glow Wire Test 960 °C) IEC® 61439.1 IEC® 61439.1 Class II UV rating according to UL 2556 and UL 854 CE RoHS EN 45545 : HL2 classification Marine & Offshore application certified by : DNV-GL, Bureau Veritas, ABS



Dimension and Packing Unit

Use with Circuit Breaker	Part Number	Article Number	Cross Section mm ²	Conductor Width mm	Conductor Thickness mm	L mm	A mm	B mm	C mm	D mm	HS1 mm	HS2 mm	
125/160A 	IBSBADV25-230	534400	25	12	2,8	230	6,5	6,5	18	9	6,5	6,5	10
	IBSBADV25-330	534401	25	12	2,8	330	6,5	6,5	18	9	6,5	6,5	10
	IBSBADV25-430	534402	25	12	2,8	430	6,5	6,5	18	9	6,5	6,5	10
	IBSBADV25-530	534403	25	12	2,8	530	6,5	6,5	18	9	6,5	6,5	10
	IBSBADV25-630	534404	25	12	2,8	630	6,5	6,5	18	9	6,5	6,5	10
	IBSBADV25-830	534405	25	12	2,8	830	6,5	6,5	18	9	6,5	6,5	10
	IBSBADV25-1030	534406	25	12	2,8	1030	6,5	6,5	18	9	6,5	6,5	10
	IBSADV25-230	534500	25	20	1,9	230	10	12	25	6	8,5	10,5	10
	IBSADV25-330	534501	25	20	1,9	330	10	12	25	6	8,5	10,5	10
	IBSADV25-430	534502	25	20	1,9	430	10	12	25	6	8,5	10,5	10
	IBSADV25-530	534503	25	20	1,9	530	10	12	25	6	8,5	10,5	10
	IBSADV25-630	534504	25	20	1,9	630	10	12	25	6	8,5	10,5	10
	IBSADV25-830	534505	25	20	1,9	830	10	12	25	6	8,5	10,5	10
	IBSADV25-1030	534506	25	20	1,9	1030	10	12	25	6	8,5	10,5	10
250A 	IBSBADV50-230	534407	50	20	2,8	230	9	11	27	8	8,5	10,5	10
	IBSBADV50-330	534408	50	20	2,8	330	9	11	27	8	8,5	10,5	10
	IBSBADV50-430	534409	50	20	2,8	430	9	11	27	8	8,5	10,5	10
	IBSBADV50-530	534410	50	20	2,8	530	9	11	27	8	8,5	10,5	10
	IBSBADV50-630	534411	50	20	2,8	630	9	11	27	8	8,5	10,5	10
	IBSBADV50-830	534412	50	20	2,8	830	9	11	27	8	8,5	10,5	10
	IBSBADV50-1030	534413	50	20	2,8	1030	9	11	27	8	8,5	10,5	10
	IBSADV50-230	534507	50	20	2,8	230	12	12	27	8	10,5	10,5	10
	IBSADV50-330	534508	50	20	2,8	330	12	12	27	8	10,5	10,5	10
	IBSADV50-430	534509	50	20	2,8	430	12	12	27	8	10,5	10,5	10
	IBSADV50-530	534510	50	20	2,8	530	12	12	27	8	10,5	10,5	10
	IBSADV50-630	534511	50	20	2,8	630	12	12	27	8	10,5	10,5	10
	IBSADV50-830	534512	50	20	2,8	830	12	12	27	8	10,5	10,5	10
	IBSADV50-1030	534513	50	20	2,8	1030	12	12	27	8	10,5	10,5	10
300A 	IBSBADV70-230	534414	70	20	4,3	230	9	11	27	11	8,5	10,5	10
	IBSBADV70-330	534415	70	20	4,3	330	9	11	27	11	8,5	10,5	10
	IBSBADV70-430	534416	70	20	4,3	430	9	11	27	11	8,5	10,5	10
	IBSBADV70-530	534417	70	20	4,3	530	9	11	27	11	8,5	10,5	10
	IBSBADV70-630	534418	70	20	4,3	630	9	11	27	11	8,5	10,5	10
	IBSBADV70-830	534419	70	20	4,3	830	9	11	27	11	8,5	10,5	10
	IBSBADV70-1030	534420	70	20	4,3	1030	9	11	27	11	8,5	10,5	10
350A 	IBSBADV100-230	534421	100	24	5	230	9	11	31	13	8,5	10,5	10
	IBSBADV100-330	534422	100	24	5	330	9	11	31	13	8,5	10,5	10
	IBSBADV100-430	534423	100	24	5	430	9	11	31	13	8,5	10,5	10
	IBSBADV100-530	534424	100	24	5	530	9	11	31	13	8,5	10,5	10
	IBSBADV100-630	534425	100	24	5	630	9	11	31	13	8,5	10,5	10
	IBSBADV100-830	534426	100	24	5	830	9	11	31	13	8,5	10,5	10
	IBSBADV100-1030	534427	100	24	5	1030	9	11	31	13	8,5	10,5	10
400A 	IBSBADV120-230	534428	120	32	4,4	230	11	11	39	12	10,5	10,5	2
	IBSBADV120-330	534429	120	32	4,4	330	11	11	39	12	10,5	10,5	2
	IBSBADV120-430	534430	120	32	4,4	430	11	11	39	12	10,5	10,5	2
	IBSBADV120-530	534431	120	32	4,4	530	11	11	39	12	10,5	10,5	2
	IBSBADV120-630	534432	120	32	4,4	630	11	11	39	12	10,5	10,5	2
	IBSBADV120-830	534433	120	32	4,4	830	11	11	39	12	10,5	10,5	2
500A 	IBSBADV185-330	534435	185	32	7,1	330	12	14	39	16	10,5	12,5	2
	IBSBADV185-430	534436	185	32	7,1	430	12	14	39	16	10,5	12,5	2
	IBSBADV185-530	534437	185	32	7,1	530	12	14	39	16	10,5	12,5	2
	IBSBADV185-630	534438	185	32	7,1	630	12	14	39	16	10,5	12,5	2
	IBSBADV185-830	534439	185	32	7,1	830	12	14	39	16	10,5	12,5	2
	IBSBADV185-1030	534440	185	32	7,1	1030	12	14	39	16	10,5	12,5	2
630A 	IBSBADV240-330	534441	240	32	9,2	330	12	14	39	18,5	10,5	12,5	2
	IBSBADV240-430	534442	240	32	9,2	430	12	14	39	18,5	10,5	12,5	2
	IBSBADV240-530	534443	240	32	9,2	530	12	14	39	18,5	10,5	12,5	2
	IBSBADV240-630	534444	240	32	9,2	630	12	14	39	18,5	10,5	12,5	2
	IBSBADV240-830	534445	240	32	9,2	830	12	14	39	18,5	10,5	12,5	2
IBSBADV240-1030	534446	240	32	9,2	1030	12	14	39	18,5	10,5	12,5	2	

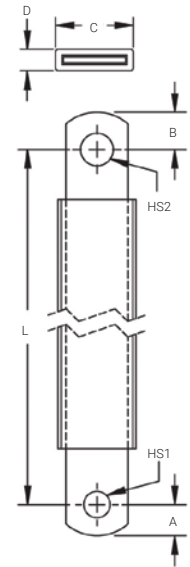

How to select nVent ERIFLEX IBS & IBSB Advanced

When sizing a conductor, the air temperature around the conductor is a very important parameter, mainly affected by factors such as convection type, protection level of enclosure or the temperature rise. Based on IEC 61439 standards, the ambient air temperature does not exceed +40°C and its average over a period of 24h does not exceed +35°C.

For IBS & IBSB Advanced, we provided an ampacity table under different temperature rise, a lower temperature rise maybe used when the ambient temperature is higher than usual.

TEMPERATURE RISE OF THE CONDUCTOR.

Temperature rise of the conductor (ΔT) = Temperature of the conductor – Internal temperature of the panel.

• Temperature rise of conductor = $T_2 - T_1 = \Delta T$ (C°)

Example:

For a requested current of 630A, with: $T_1 = 40^\circ\text{C}$ and $T_2 = 90^\circ\text{C}$

• $\Delta T = 90 - 40 = 50^\circ\text{C}$

- in the ΔT 50°C column, find the closest current value to 630A

Result: IBSB Advanced 240 mm² – 718A (IEC & UL)

For IBS & IBSB Advanced, we recommend the maximum temperature rise does not exceed 50°C for a normal application. Generally, 50°C is chosen as the default temperature rise considering the ambient temperature inside the panel is below 40°C. But when the connected section is an electrical component which may dissipate heat (for example circuit breaker) or the ventilation inside the enclosure is not efficient, it may be necessary to choose lower temperature rise.

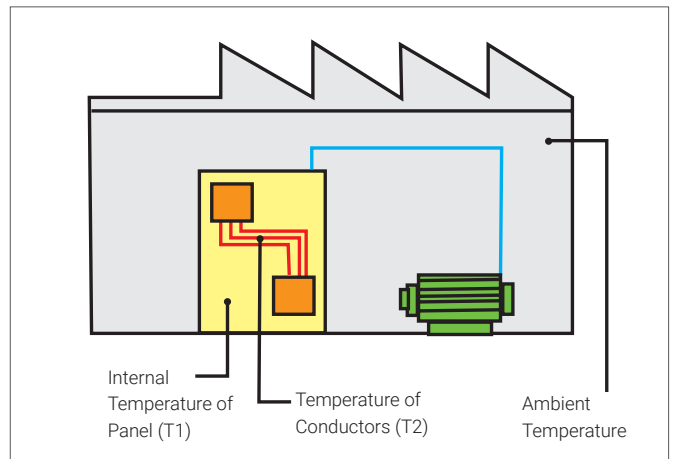

Insulated Braided conductor type	Cross Section mm ² (kcmil)	Maximum Ampacity Ratings							Current Coefficient	
		ΔT 30° C (A)	ΔT 40° C (A)	ΔT 45° C (A)	ΔT 50° C (A)	ΔT 55° C (A)	ΔT 60° C (A)	ΔT 70° C (A)		
IBSB ADV 25	25 (49,34)	116	134	142	150	157	164	177	1,6	2
IBS ADV 25	25 (49,34)	137	158	167	177	185	193	209	1,6	2
IBS ADV 50 IBSB ADV 50	50 (98,68)	213	246	260	274	288	301	325	1,6	2
IBSB ADV 70	70 (138,15)	226	261	277	291	306	319	345	1,6	2
IBSB ADV 100	100 (197,35)	298	344	365	385	404	422	456	1,6	2
IBSB ADV 120	120 (236,82)	363	419	444	468	491	513	554	1,6	2
IBSB ADV 185	185 (365,1)	416	480	509	537	563	588	635	1,6	2
IBSB ADV 240	240 (473,65)	556	642	681	718	753	786	849	1,6	2

Admissible currents: This table indicates the temperature rise produced by chosen current in the given section. This calculation does not take into account the heat dissipation from the switch gear.

IBS & IBSB ADVANCED IN PARALLEL

When using 2 or 3 IBS & IBSB Advanced in parallel for the same phase, use the current coefficient showed on the above IEC & UL ampacities table.

Example:

IBSB Advanced 240 mm² – $\Delta T = 50^\circ\text{C}$: 718 A (IEC & UL)

- 2 Braids in parallel: $718 \text{ A} \times 1,6 = 1149 \text{ A}$
- 3 Braids in parallel: $718 \text{ A} \times 2 = 1436 \text{ A}$

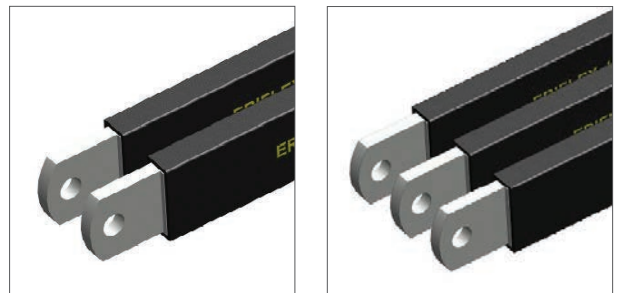

IBS & IBSB Advanced Connection on Molded Case Circuit Breaker

The IBS & IBSB Advanced range can be used as an alternative to cable for all low-voltage applications. It is suitable and connectable for molded case circuit breaker ranges, including most compact breakers on the market. From 80A up to 630A circuit breakers, you can directly connect the IBS & IBSB Advanced on the front access terminals breaker without additional accessories, such as angular connectors, spreaders, ring terminal connectors or extenders. No lugs and no cutting, stripping or crimping are necessary.

Simple, quick, ready to use!

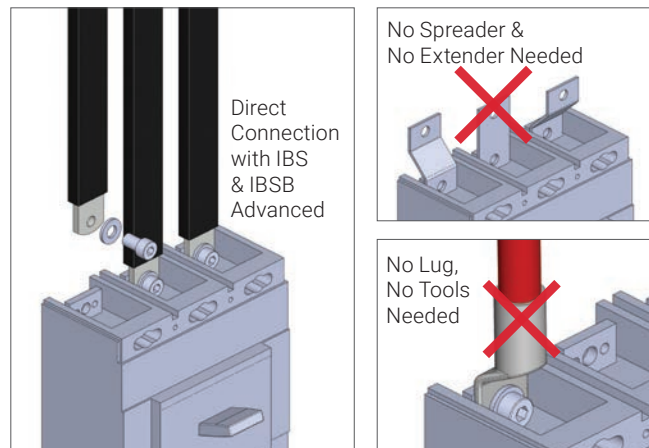

CIRCUIT BREAKER COMPATIBILITY

Circuit Breaker Current Rating	125/160 A		250 A		300 A	350 A	400 A	500 A	630 A
Insulated Braided conductor type	IBSB ADV 25x	IBS ADV 25x	IBSB ADV 50x	IBS ADV 50x	IBSB ADV 70x	IBSB ADV 100x	IBSB ADV 120x	IBSB ADV 185x	IBSB ADV 240x
Schneider Electric Compact (IEC)	NSA NG 125	NSX 100 NSX 160	NSX 250	NSX 250	NSX 400	NSX 400	NSX 400	NSX 630	NSX 630
Square D PowerPact (UL)	H-Frame	J-Frame	J-Frame	J-Frame	L-Frame	L-Frame	L-Frame	-	-
ABB Tmax (IEC)	T1 T2 XT1 XT2	-	T3 XT3 XT4	T3 XT3 XT4	T4	T4	T5	T5	T5
ABB Tmax (UL)	T1 T2 XT1 XT2	T3	T4 XT3 XT4	T4 XT3 XT4	T5	T5	T5	-	-
GE Record Plus (IEC/UL)	FD 160	FE 160	FE 250	FE 250	FG 400	FG 400	FG 400	FG 630	FG 630
Siemens Sentron (IEC/UL)	VL160X 3VL1 VL160 3VL2	-	VL250 3VL3	VL250 3VL3	VL400 3VL4	VL400 3VL4	VL400 3VL4	-	-
Moeller xEnergy (IEC)	NZM1		NZM2	NZM2	NZM3	NZM3	NZM3	NZM3	NZM3
Cutler Hammer Series G (UL)	EG Frame	JG Frame	JG Frame	JG Frame	LG Frame	LG Frame	LG Frame	LG Frame	LG Frame
Legrand (IEC)	DPX 160 DPX3 160	-	DPX 250 DPX3 250	DPX 250 DPX3 250	DPX 630	DPX 630	DPX 630	DPX 630	DPX 630
Hager (IEC)	h3 160	-	h3 250	h3 250	h3 630	h3 630	-	-	-
Rockwell/Allen Bradley (UL)	G-Frame H-Frame	-	I-Frame J-Frame	I-Frame J-Frame	I-Frame J-Frame	-	K-Frame	K-Frame	-
Mitsubishi Electric (IEC)	-	NF125 NF160 DSN125 DSN160	NF250 DSN250	NF250 DSN250	-	NF400 DSN400	-	-	-
OEZ (IEC)	BC160N	-	BD250N BD250S	BD250N BD250S	BH630B BH630S	BH630B BH630S	BH630B BH630S	BH630B BH630S	BH630B BH630S

This table does not take into account the specific installation environment, like ambient temperature, protection level of enclosure, altitude, frequency.

Some MCCB may need more important cross section in function of the MCCB Power dissipation. In some cases, increasing the IBS & IBSB Advanced cross section may be necessary to support MCCB heating dissipation. It is therefore necessary to respect the instructions provided by the electrical device manufacturer.

Round Insulated Braided Conductor IBS Advanced

IBS 120
IBS 185
IBS 240



INSULATION

- Dielectric Strength: 20 kV/mm
- Insulation Elongation: 500 %
- Insulation Thickness: 1,8 mm
- Max Working Voltage, IEC/UL 758: 1,000 VAC; 1,500 VDC
- Max Working Voltage, UL 67: 600 VAC/DC
- Working Temperature: -50 to 115 °C
- Certification Details: UL® 67; UL® 758
- Complies With: IEC® 60695-2-11 (Glow Wire Test 960 °C); IEC® 61439.1; IEC® 61439.1 Class II
- UV rating according to UL 2556 and UL 854

BRAID

- Tinned electrolytic copper for better corrosion protection
- Wire diameter: 0,15 mm for maximum flexibility

CERTIFICATION & APPROVAL

- Flammability Rating: UL® 94V-0
- Halogen Free Rating: UL® 2885; IEC® 60754-1; IEC® 62821-1
- Low Smoke Rating: IEC® 61034-2; ISO 5659-2; UL® 2885
- IEC 61439.1
- cRUus per UL67 & CAN/CSA C22.2 No. 29
- CE conformity
- RoHS compliant
- RU per UL758
- American Bureau of Shipping (ABS) Bureau Veritas : Marine & Offshore application.
- CSA C22.2 No 210 for appliance wiring material products
- Conforms to NF EN 45545 obtaining an HL2 classification for chapters R22 and R23

DIELECTRIC TEST

- 3500 VAC, 1 minute according to the IEC 61439 standard (rated insulation voltage U_i 1000 VAC)
- 6000 VAC, 1 minute with 6 mA creepage current set up

FEATURES

- Resistant to vibration, improving reliability and performance
- Insulated by high-resistance, halogen free, flame retardant and low smoke material
- Tinned copper provides superior corrosion resistance
- Improves assembly flexibility and aesthetics
- Quick and easy installation
- No additional cutting, stripping, crimping and punching needed

TECHNICAL DATA

- Intensity = 100A up to 1000A
- Excellent electrical contact
- Good tensile strength



Round Insulated Braided Conductor IBS Advanced

IBS 120
IBS 185
IBS 240

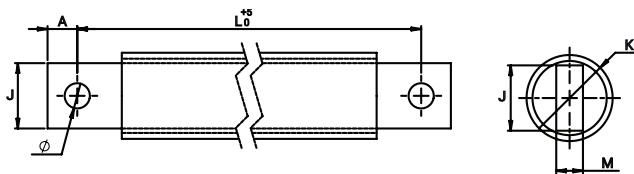

	Part No.	IBS 120	S mm ²	L mm	Ø mm	A mm	J mm	M mm	K mm		Kg
400 A	534514	IBS 120-330-10	120	330	10,5	12	24	10	27	2	0,51
	534515	IBS 120-430-10	120	430	10,5	12	24	10	27	2	0,67
	534516	IBS 120-530-10	120	530	10,5	12	24	10	27	2	0,82
	534517	IBS 120-630-10	120	630	10,5	12	24	10	27	2	0,98
	534518	IBS 120-830-10	120	830	10,5	12	24	10	27	2	1,29
	534519	IBS 120-1030-10	120	1030	10,5	12	24	10	27	2	1,6

	Part No.	IBS 185	S mm ²	L mm	Ø mm	A mm	J mm	M mm	K mm		Kg
500 A	534520	IBS 185-330-10	185	330	10,5	12	24	15	31	2	0,82
	534521	IBS 185-430-10	185	430	10,5	12	24	15	31	2	1,07
	534522	IBS 185-530-10	185	530	10,5	12	24	15	31	2	1,26
	534523	IBS 185-630-10	185	630	10,5	12	24	15	31	2	1,48
	534524	IBS 185-830-10	185	830	10,5	12	24	15	31	2	1,9
	534525	IBS 185-1030-10	185	1030	10,5	12	24	15	31	2	2,3

	Part No.	IBS 240	S mm ²	L mm	Ø mm	A mm	J mm	M mm	K mm		Kg
630 A	534526	IBS 240-330-12	240	330	12,5	13	32	15	36	2	1,03
	534527	IBS 240-430-12	240	430	12,5	13	32	15	36	2	1,34
	534528	IBS 240-530-12	240	530	12,5	13	32	15	36	2	1,65
	534529	IBS 240-630-12	240	630	12,5	13	32	15	36	2	1,96
	534530	IBS 240-830-12	240	830	12,5	13	32	15	36	2	2,58
	534531	IBS 240-1030-12	240	1030	12,5	13	32	15	36	2	3,2

Insulated Braided conductor type	Section mm ²	ΔT (K)							Current Coefficient
		30	40	45	50	55	60	70	
IBS 120	120	325	376	398	420	441	460	497	1,6
IBS 185	185	407	470	499	526	552	576	622	1,6
IBS 240	240	488	563	598	630	661	690	745	1,6

ADMISSIBLE CURRENTS: This table indicates the temperature rise produced by chosen current in the given section. This calculation does not take into account the heat dissipation from the switch gear.

Advanced Insulated Braided IBSHY Conductor for Compact Circuit Breakers

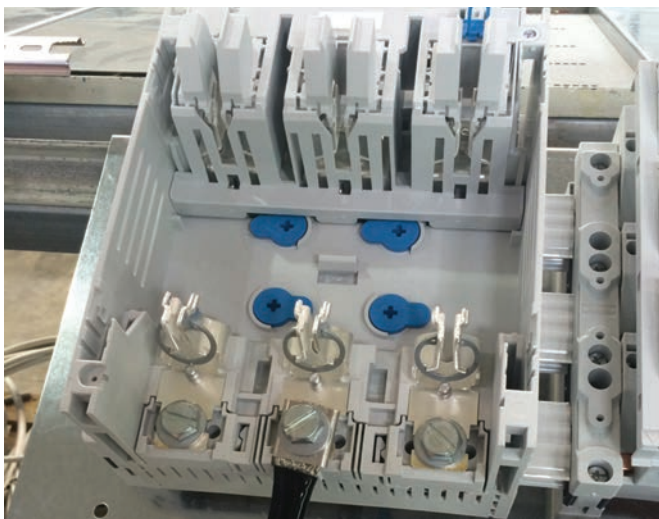

FEATURES

- Suitable for all main 125/160 A electrical devices and specifically molded case circuit breakers
- Resistant to vibration, improving reliability and performance
- Improves assembly flexibility and aesthetics
- Quick and easy installation
- No additional cutting, stripping, crimping and punching needed
- Small wire diameter provides maximum flexibility
- Halogen-free solution for applications requiring a low smoke solution
- DNV-GL certified busbar systems for electrical installation for ship and marine application
- Conforms to NF EN 45545 obtaining an HL2 classification for chapters R22 and R23
- High working temperature
- RoHS compliant

IBSHY INSULATED BAIDED CONDUCTOR SPECIFICATIONS

- Typical Application Current Rating: 160 A
- Finish: Tinned
- Material: Copper; Glass Fibre Reinforced Silicon
- Flammability Rating: UL 1441 VW-1
- Max Working Voltage, IEC (U_i): 1 000 VAC; 1 500 VDC
- Operating Temperature: from -60 °C to 250 °C
- Wire Diameter: 0,15 mm
- IEC 61439-1 compliant

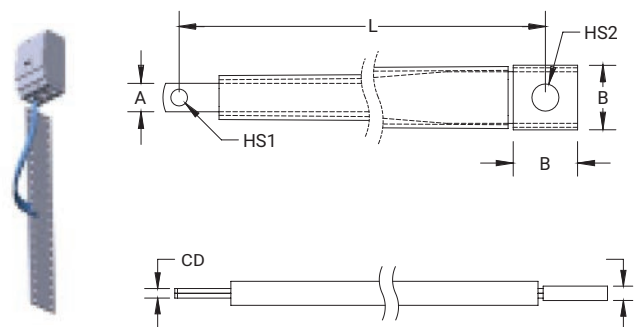

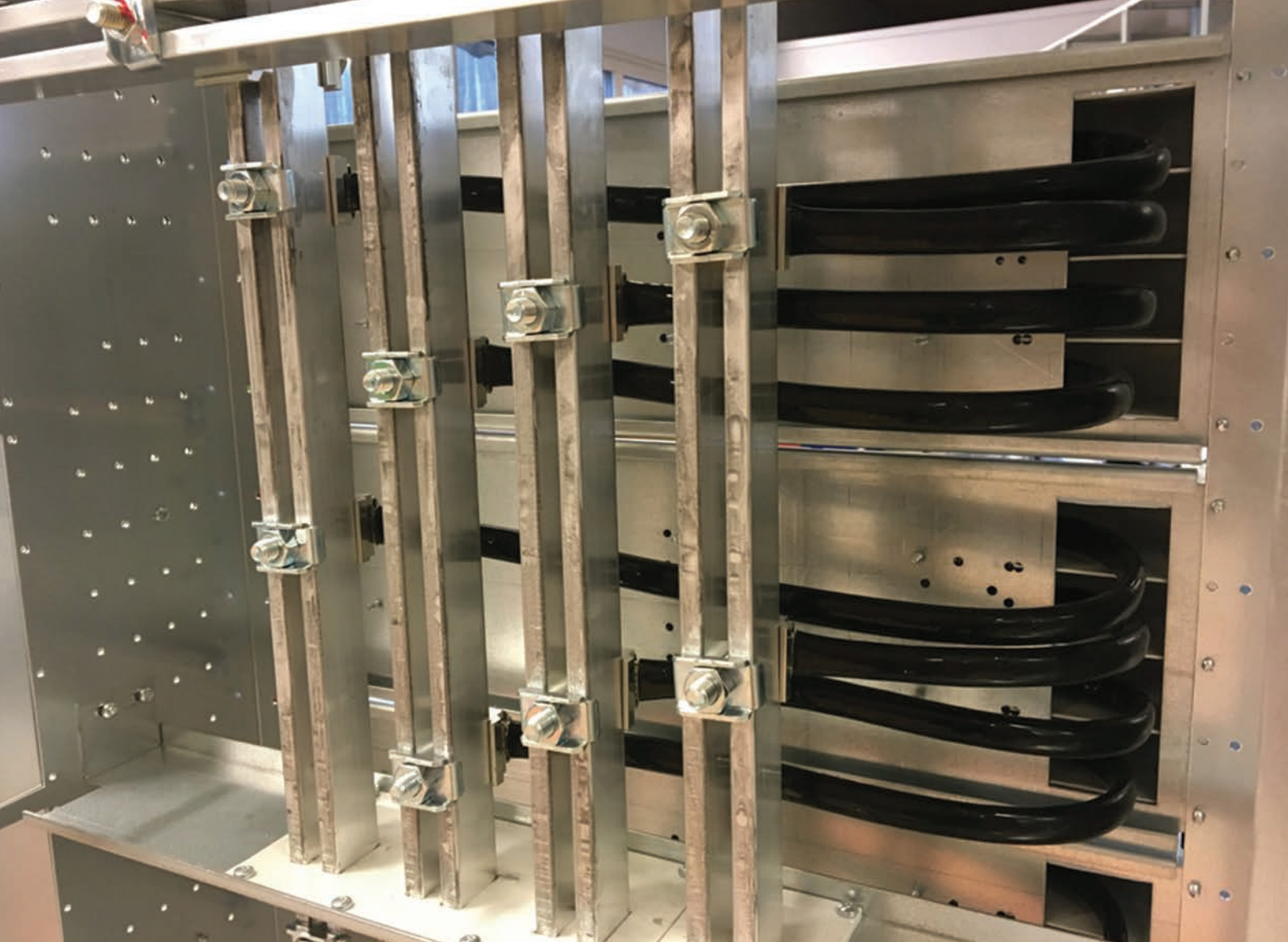

IBSHY ADVANCED INSULATED BAIDED CONDUCTOR TECHNICAL CHARACTERISTICS

Part No.	Article No.	Cross Section	Length L	A	B	C	D	Hole Size 1 HS1	Hole Size 2 HS2
IBSHY32-230	558584	32 mm ²	230 mm	11 mm	25 mm	3 mm	5 mm	6,5 mm	10,5 mm
IBSHY32-330	558586	32 mm ²	330 mm	11 mm	25 mm	3 mm	5 mm	6,5 mm	10,5 mm
IBSHY32-365	558587	32 mm ²	365 mm	11 mm	25 mm	3 mm	5 mm	6,5 mm	10,5 mm
IBSHY32-430	558588	32 mm ²	430 mm	11 mm	25 mm	3 mm	5 mm	6,5 mm	10,5 mm
IBSHY32-500	558589	32 mm ²	500 mm	11 mm	25 mm	3 mm	5 mm	6,5 mm	10,5 mm
IBSHY32-565	558591	32 mm ²	565 mm	11 mm	25 mm	3 mm	5 mm	6,5 mm	10,5 mm
IBSHY32-630	558592	32 mm ²	630 mm	11 mm	25 mm	3 mm	5 mm	6,5 mm	10,5 mm
IBSHY32-700	558593	32 mm ²	700 mm	11 mm	25 mm	3 mm	5 mm	6,5 mm	10,5 mm
IBSHY32-765	558594	32 mm ²	765 mm	11 mm	25 mm	3 mm	5 mm	6,5 mm	10,5 mm
IBSHY32-830	558595	32 mm ²	830 mm	11 mm	25 mm	3 mm	5 mm	6,5 mm	10,5 mm

Maximum Ampacity Ratings															
Cross Section (mm ² /kcmil)	ΔT 30° C (A)	ΔT 35° C (A)	ΔT 40° C (A)	ΔT 45° C (A)	ΔT 50° C (A)	ΔT 55° C (A)	ΔT 60° C (A)	ΔT 65° C (A)	ΔT 70° C (A)	ΔT 75° C (A)	ΔT 80° C (A)	ΔT 100° C (A)	ΔT 120° C (A)	2 Bar Current Coefficient	3 Bar Current Coefficient
32/63,15	142	153	164	174	184	193	201	209	217	225	235	263	290	1,6	2

ΔT = Temperature of conductors – Internal temperature of panel.

This table indicates the temperature rise produced by chosen current in the given section. This calculation does not take into account the heat dissipation from the switch gear.



ASSEMBLY INSTRUCTIONS

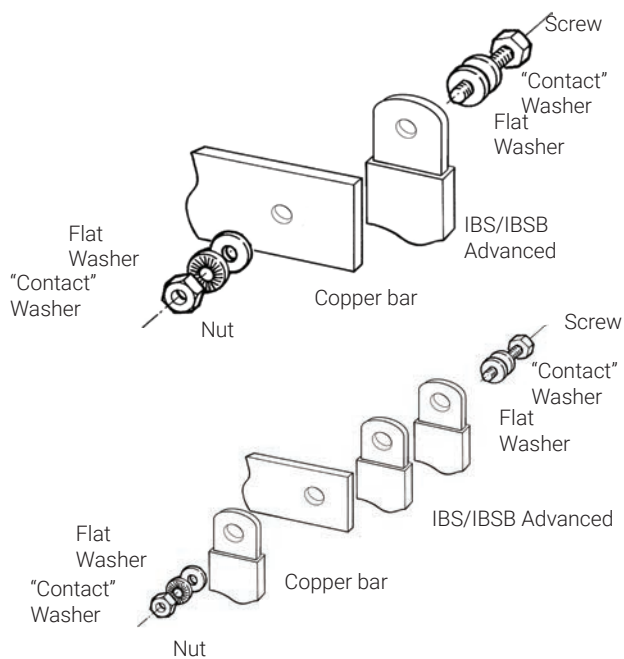

Space between 2 or 3 insulated braided conductors in parallel, for cooling.

A minimum air gap is required. Use FS type spacer clamp.

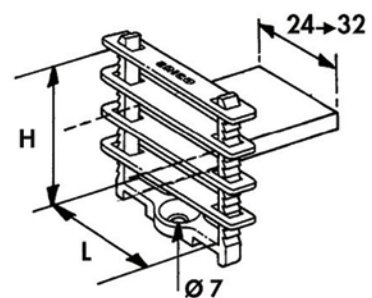

Designation	Part No.	For insulated braided conductor type
FS 24	553550	IBS Advanced 25 / 50 IBSB Advanced 25 / 50 / 70 / 100
FS 32	553560	IBSB Advanced 120 / 185 / 240

Grounding and Bonding tinned Copper Braids (MBJ & BJ)



INNOVATIVE, STATE-OF-THE-ART MANUFACTURING PROCESS.

nVent ERIFLEX manufacturing directly massivates the palms of the MBJ tinned-plated braids. This manufacturing process provides an effective electrical contact, due to the integral palms, without the addition of tin or crimped lugs.

This process welds the flexible braid and brings back a solid tinned or red copper block as a palm. Unlike the traditional press-welded palms process, nVent ERIFLEX's process is suitable for red copper, but also for tin plated copper. The electrical contact between each wire is optimized.



This nVent ERIFLEX process also helps eliminate moisture issues in the palms. By using crimped lugs in a severe environment, moisture can enter in the lug (often by capillarity) and create corrosion between each wire. After several years, the electrical contact between each wire can deteriorate and alter the electrical conductivity of the equipment. The corrosion in the palm is impossible to remove without changing the element.

This process produces RoHS products; no additional substances are added to the tinned-plated wires during the manufacturing process.

BJ

Round braids with crimped lugs



Part No.	Description	Section mm	L mm	Ø D mm	Intensity A		 Kg
556900	BJ 6-150 S	6	150	6,5	45	10	0,010
556910	BJ 6-200 S	6	200	6,5	45	10	0,015
556920	BJ 10-300 S	10	300	6,5	75	10	0,033

TINNED COPPER EARTH/GROUND BRAIDS TECHNICAL FEATURES

With integral palm

- A complete range of earth/ground flexible connections from 6 to 100 mm² section and from 100 to 500 mm length
- Strong resistance to vibration and fatigue
- Reliable: No extra contact due to the lugs crimped at the ends of the cable
- Weight savings: A flat braid weighs less than a cable (with insulation) and lugs and offers better copper usage (skin effect)
- Integral palm, without tin or crimped lugs for superior electrical contact and tensile strength resistance
- Quick and easy to install: Ready to use. No cutting, stripping, crimping or punching. Less labor time for installation
- Material savings: no lugs or terminals
- Recommended by the EMC/EMI directives and less impedance than cables



GROUNDING AND BONDING TINNED COPPER BRAIDS (MBJ & BJ) TECHNICAL CHARACTERISTICS

Part Number	Description	Intensity A	Thickness mm	Section mm ²	L mm	Ø mm	J mm	T mm		Kg
556600	MBJ 6-150-6	40	1,1	6	150	6,5	11	18	10	0,01
563410	MBJ 6-200-6	40	1,1	6	200	6,5	11	18	10	0,0167
556930	MBJ 10-200-6	75	1,1	10	200	6,5	11	18	10	0,022
556610	MBJ 10-300-6	75	1,1	10	300	6,5	11	18	10	0,033
563540	MBJ 16-100-6	120	1,5	16	100	6,5	15	20	10	0,018
556620	MBJ 16-100-8	120	1,5	16	100	8,5	15	20	10	0,018
563550	MBJ 16-150-6	120	1,5	16	150	6,5	15	20	10	0,035
556630	MBJ 16-150-8	120	1,5	16	150	8,5	15	20	10	0,035
563300	MBJ 16-200-6	120	1,5	16	200	6,5	15	20	10	0,033
556640	MBJ 16-200-8	120	1,5	16	200	8,5	15	20	10	0,033
556650	MBJ 16-250-8	120	1,5	16	250	8,5	15	20	10	0,04
563320	MBJ 16-300-6	120	1,5	16	300	6,5	15	20	10	0,05
556660	MBJ 16-300-8	120	1,5	16	300	8,5	15	20	10	0,05
556940	MBJ 16-500-8	120	1,5	16	500	8,5	15	20	10	0,082
556670	MBJ 25-100-10	150	1,9	25	100	10,5	19,5	28	10	0,027
556680	MBJ 25-150-10	150	1,9	25	150	10,5	19,5	28	10	0,039
563340	MBJ 25-200-6	150	1,9	25	200	6,5	19,5	28	10	0,052
555200	MBJ 25-200-8	150	1,9	25	200	8,5	19,5	28	10	0,052
556690	MBJ 25-200-10	150	1,9	25	200	10,5	19,5	28	10	0,052
563430	MBJ 25-200-12	150	1,9	25	200	12,5	19,5	28	10	0,052
556700	MBJ 25-250-10	150	1,9	25	250	10,5	19,5	28	10	0,064
555201	MBJ 25-300-8	150	1,9	25	300	8,5	19,5	28	10	0,077
556710	MBJ 25-300-10	150	1,9	25	300	10,5	19,5	28	10	0,077
556950	MBJ 25-500-10	150	1,9	25	500	10,5	19,5	28	10	0,13
556720	MBJ 30-100-10	180	2	30	100	10,5	22	28	10	0,032
556730	MBJ 30-150-10	180	2	30	150	10,5	22	28	10	0,047
556740	MBJ 30-200-10	180	2	30	200	10,5	22	28	10	0,062
556750	MBJ 30-250-10	180	2	30	250	10,5	22	28	10	0,075
556760	MBJ 30-300-10	180	2	30	300	10,5	22	28	10	0,092
556960	MBJ 30-500-10	180	2	30	500	10,5	22	28	10	0,155
556770	MBJ 35-100-10	197	2,1	35	100	10,5	22	28	10	0,037
556780	MBJ 35-150-10	197	2,1	35	150	10,5	22	28	10	0,054
556790	MBJ 35-200-10	197	2,1	35	200	10,5	22	28	10	0,072
556800	MBJ 35-250-10	197	2,1	35	250	10,5	22	28	10	0,089
565000	MBJ 35-250-25	197	3	35	250	25,5	40	45	10	0,089
556810	MBJ 35-300-10	197	2,1	35	300	10,5	22	28	10	0,11
556970	MBJ 35-500-10	197	2,1	35	500	10,5	22	28	10	0,18
556820	MBJ 50-100-10	250	2,5	50	100	10,5	28	33	10	0,052
556830	MBJ 50-150-10	250	2,5	50	150	10,5	28	33	10	0,077
563350	MBJ 50-200-6	250	2,5	50	200	6,5	28	33	10	0,12
556840	MBJ 50-200-10	250	2,5	50	200	10,5	28	33	10	0,12
563440	MBJ 50-200-12	250	2,5	50	200	12,5	28	33	10	0,12
563360	MBJ 50-200-16	250	2,5	50	200	16,5	28	33	10	0,11
563370	MBJ 50-200-18	250	2,5	50	200	18,5	28	33	10	0,11
556850	MBJ 50-250-10	250	2,5	50	250	10,5	28	33	10	0,127
563380	MBJ 50-300-6	250	2,5	50	300	6,5	28	33	10	0,15
556860	MBJ 50-300-10	250	2,5	50	300	10,5	28	33	10	0,153
563390	MBJ 50-300-16	250	2,5	50	300	16,5	28	33	10	0,15
563400	MBJ 50-300-18	250	2,5	50	300	18,5	28	33	10	0,14
556980	MBJ 50-500-10	250	2,5	50	500	10,5	28	33	10	0,255
563560	MBJ 50-500-12	250	2,5	50	500	12,5	28	33	10	0,255
563450	MBJ 70-300-6	290	3,4	70	300	6,5	28	33	10	0,21
563460	MBJ 70-300-10	290	3,4	70	300	10,5	28	33	10	0,21
563420	MBJ 70-300-12	290	3,4	70	300	12,5	28	33	10	0,21
563470	MBJ 70-300-16	290	3,4	70	300	16,5	28	33	10	0,2
563480	MBJ 70-300-22	290	3	70	300	22,5	40	45	10	0,2
563490	MBJ 70-500-10	290	3,4	70	500	10,5	28	33	10	0,34
563500	MBJ 100-250-16	349	4	100	250	16,5	40	55	10	0,254
563510	MBJ 100-250-30	349	4	100	250	30,5	40	55	10	0,254
563520	MBJ 100-500-16	349	4	100	500	16,5	40	55	10	0,508
563530	MBJ 100-500-30	349	4	100	500	30,5	40	55	10	0,508

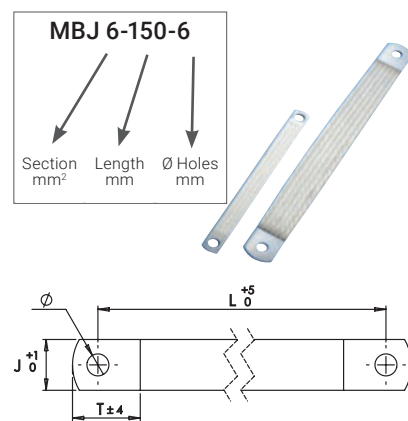

TECHNICAL DATA

- Recommended by EMC/EMI directives
- Flat tinned copper braids
- Electrolytic copper Cu-ETP according to standard EN13602
- Copper purity of minimum 99,9%
- Maximum resistivity of 0,017241 mm²/m at 20°C
- Standard wire diameter; 0,15 mm
- Bends very close to the contact area

CERTIFICATION & APPROVALS

- UL Listed (UL467) except BJ
- EAC certificate
- RoHS 2002/95/EC Compliant
- IEC 61439-1

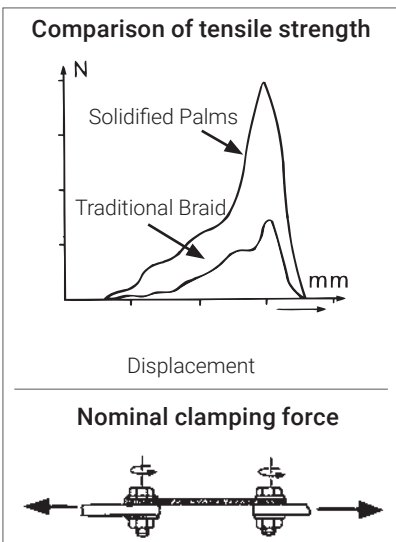

Grounding and Bonding Braid, Tinned Copper with Halogen Free & Flame retardant Yellow Green insulation

MBJ YG

MBJYG Grounding and Bonding Braids are a reliable and convenient ground solution for applications that require flexibility and durability. Designed with halogen-free and flame retardant Yellow Green insulation, MBJYG braids are made with tinned copper ground braids and solid palms that are ready to install without any additional cutting, stripping, crimping or punching. MBJYG braids also do not require the addition of tin or crimped lugs and the proprietary manufacturing process helps optimize the electrical contact between each wire and helps eliminate moisture issues in the palms, helping prevent corrosion and extend the useful life of the braid.

TECHNICAL DATA

- Provides weight and material savings with lower impedance when compared to similar lugged cables with insulation (Recommended by the EMC/EMI directives)



TECHNICAL FEATURE

- Tinned copper Integral palm, without crimped lugs for superior electrical contact and tensile strength resistance
- Complete range of earth/ground flexible connections from 6 - 25 mm² (11.84 - 49.33 kcmil) cross section and from 100 - 300 mm (3.937" - 11.811") length
- Working Temperature: -55 to 125 °C
- Ready to use out of the box, eliminating the need for cutting, stripping, crimping and punching
- Resistant to vibration and fatigue, reducing maintenance



CERTIFICATION & APPROVALS

- Halogen free and Flame retardant yellow green insulation
- UL 467 listed and IEC 61439-1 certified

Part Number	Article Number	Current A	Thickness T mm	Cross Section mm ²	Length L mm	Hole Size HS mm	A mm	B mm	Kg	
MBJYG6-100-6	563601	40	1,1	6	100	6,5	11	18	0,012	10 pc
MBJYG6-150-6	563602				150				0,017	
MBJYG6-200-6	563603				200				0,013	
MBJYG6-250-6	563604				250				0,028	
MBJYG6-300-6	563605				300				0,02	
MBJYG10-100-6	563606	75	1,1	10	100	6,5	11	18	0,012	10 pc
MBJYG10-150-6	563607				150				0,017	
MBJYG10-200-6	563608				200				0,013	
MBJYG10-250-6	563609				250				0,028	
MBJYG10-300-6	563611				300				0,02	
MBJYG16-100-8	563612	120	1,5	16	100	8,5	15	20	0,02	10 pc
MBJYG16-150-8	563613				150				0,028	
MBJYG16-200-8	563614				200				0,036	
MBJYG16-250-8	563615				250				0,044	
MBJYG16-300-8	563616				300				0,052	
MBJYG25-100-8	563617	150	1,9	25	100	8,5	19,5	28	0,03	10 pc
MBJYG25-150-8	563618				150				0,044	
MBJYG25-200-8	563619				200				0,056	
MBJYG25-250-8	563621				250				0,069	
MBJYG25-300-8	563622				300				0,082	

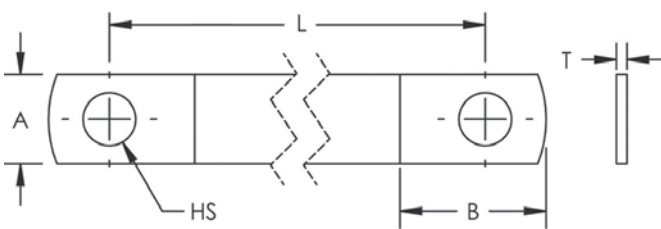

TECHNICAL DATA

- Material: Copper; Polyolefin
- Finish: Tinned
- Dielectric Strength: 15 kV/mm
- Flammability Rating: UL® 224 VW-1
- Halogen-Free Rating: EN 14582
- Nominal Voltage, UL/CSA/IEC: 600 V
- Working Temperature: -55 to 125 °C
- Complies With: IEC® 61439.1
- Certifications: CE; cULus; RoHS



Grounding & bonding braid

Stainless steel braids (CPI)



READY-TO-USE STAINLESS STEEL BRAIDS FOR MULTIPLE APPLICATIONS

nVent ERIFLEX develops and manufactures a range of grounding & bonding stainless steel braids. These high-quality 316L stainless steel braids can be installed in extremely corrosive environments, like offshore applications or coastal applications. The CPI braid is ideal for applications using stainless steel pipe or tanks, like the food and beverage industry, building industry, transportation, oil and chemical industry.

nVent ERIFLEX offers 316L stainless steel, one of the highest resistant stainless steel options on the market. nVent ERIFLEX has mastered the process of manufacturing stainless steel for braiding, crimping, cutting or punching and offers a full range of ready-to-use stainless steel braids.

CPI FEATURES

- 316L stainless steel braid ready to use
- Full application range: 16 to 70 mm² section with 150 to 1100 mm length
- High-quality 316L stainless steel: superior abrasion, corrosion, chemical, and UV resistance for outdoor applications
- Good resistance to vibration and fatigue
- Time savings: quick and easy to install. Ready to use. No additional cutting, stripping, crimping and punching needed. Less labor time for installation
- Material savings: No additional lugs or terminals needed
- Durable in outdoor, salt and corrosive environments
- Non-magnetic material
- Long maintenance cycle
- Superior abrasion, corrosion, chemical and UV resistance make it ideal for outdoor applications
- Great for expansion joints where constant movement requires a flexible and indestructible covering
- Won't rust or discolor, so the appearance will never fade or change
- No additional cutting, stripping, or crimping needed
- More flexible connection
- Pre-punched: ready to use
- Quick and easy to install
- Excellent electrical contact
- Strong resistance to vibration and fatigue
- Recommended by the EMC directives
- Reduced maintenance

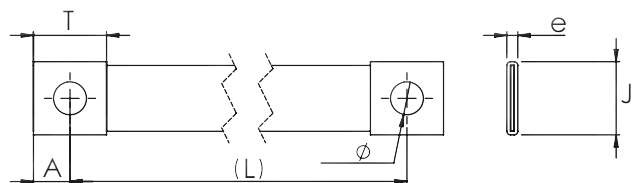
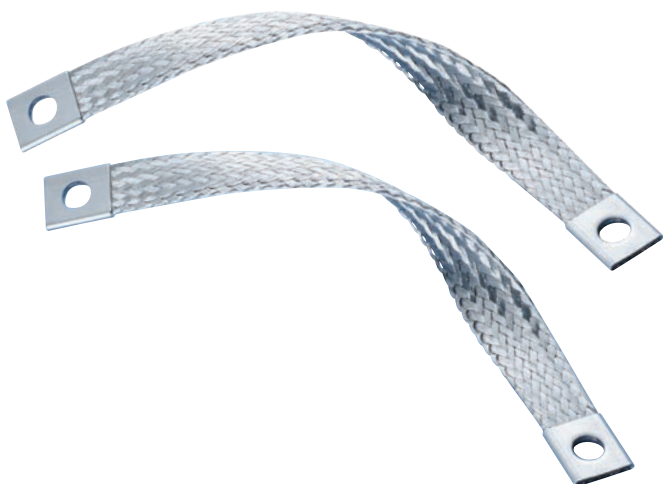

GROUNDING AND BONDING STAINLESS STEEL BRAIDS CPI TECHNICAL CHARACTERISTICS

WHERE STAINLESS BRAIDS CAN BE USED:

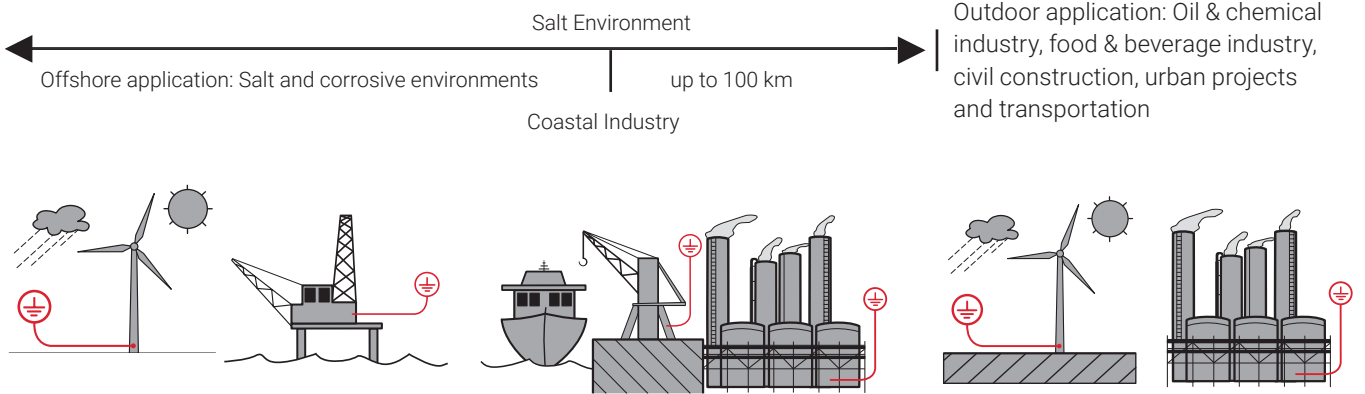

TECHNICAL DATA

- Excellent electrical contact
- Good tensile strength

BRAID

- 316L Stainless steel
- Wire diameter: 0,25 mm for maximum flexibility
- Strong resistance to vibration

CERTIFICATIONS & APPROVALS

- UL Listed UL467 - grounding and bonding equipment for US and Canada
- RoHS Compliant
- IEC 61439-1
- ABS American Bureau of Shipping Certificate No. 13-HS1018106-1-PDA-DUP

Part Number	Description	Section mm ²	L mm	Ø mm	J mm	A mm	T mm	e mm		Kg
554277	CPI 16-150-8	16	150	8,5	17,5	10	20	3	10	0,031
554278	CPI 16-200-8	16	200	8,5	17,5	10	20	3	10	0,037
554279	CPI 16-250-8	16	250	8,5	17,5	10	20	3	10	0,043
554280	CPI 16-300-8	16	300	8,5	17,5	10	20	3	10	0,050
554282	CPI 16-400-8	16	400	8,5	17,5	10	20	3	10	0,062
554286	CPI 16-600-8	16	600	8,5	17,5	10	20	3	10	0,087
554299	CPI 25-150-10	25	150	10,5	26,5	15	30	3,5	10	0,058
554300	CPI 25-200-10	25	200	10,5	26,5	15	30	3,5	10	0,068
554301	CPI 25-250-10	25	250	10,5	26,5	15	30	3,5	10	0,078
554302	CPI 25-300-10	25	300	10,5	26,5	15	30	3,5	10	0,088
554304	CPI 25-400-10	25	400	10,5	26,5	15	30	3,5	10	0,108
554308	CPI 25-600-10	25	600	10,5	26,5	15	30	3,5	10	0,147
554321	CPI 35-150-12	35	150	13	26,5	15	30	4	10	0,071
554322	CPI 35-200-12	35	200	13	26,5	15	30	4	10	0,085
554323	CPI 35-250-12	35	250	13	26,5	15	30	4	10	0,099
554324	CPI 35-300-12	35	300	13	26,5	15	30	4	10	0,112
554326	CPI 35-400-12	35	400	13	26,5	15	30	4	10	0,140
554330	CPI 35-600-12	35	600	13	26,5	15	30	4	10	0,195
554343	CPI 50-150-12	50	150	13	30	15	30	5	10	0,111
554344	CPI 50-200-12	50	200	13	30	15	30	5	10	0,130
554345	CPI 50-250-12	50	250	13	30	15	30	5	10	0,150
554346	CPI 50-300-12	50	300	13	30	15	30	5	10	0,170
554348	CPI 50-400-12	50	400	13	30	15	30	5	10	0,209
554352	CPI 50-600-12	50	600	13	30	15	30	5	10	0,288
554365	CPI 70-150-12	70	150	13	30	15	30	5,8	10	0,139
554366	CPI 70-200-12	70	200	13	30	15	30	5,8	10	0,167
554367	CPI 70-250-12	70	250	13	30	15	30	5,8	10	0,194
554368	CPI 70-300-12	70	300	13	30	15	30	5,8	10	0,222
554370	CPI 70-400-12	70	400	13	30	15	30	5,8	10	0,277
554374	CPI 70-600-12	70	600	13	30	15	30	5,8	10	0,388
554378	CPI 70-800-12	70	800	13	30	15	30	5,8	10	0,498
554384	CPI 70-1100-12	70	1100	13	30	15	30	5,8	10	0,664

Grounding and Bonding Braid, CPIW Stainless Steel for Large Bolts



High-quality CPIW stainless steel grounding and bonding braids can be installed in corrosive environments like offshore applications or coastal applications. The full range of CPIW braids are ideal for applications using stainless steel pipe or tanks, like the food and beverage industry, building industry, transportation or oil and chemical industry.

nVent ERIFLEX offers 316L stainless steel braids, one of the highest resistant stainless steel options on the market. Our proprietary manufacturing process has been optimized to provide the best braiding, welding and connection palm.



CPIW FEATURES

- Superior abrasion, corrosion, chemical and UV resistance make CPIW braids ideal for outdoor applications
- Covering from M20 (3/4"-10) up to M42 (1 1/2"-6) bolt fixation point
- Great for expansion joints where constant movement requires a flexible and durable solution
- Ready to use out of the box, eliminates the need for cutting, stripping, crimping and punching
- Quick and easy to install
- Resistant to vibration and fatigue, reducing maintenance
- Will not rust or discolor, so the appearance will never fade or change
- Excellent electrical contact
- No additional lugs or terminals needed
- Non-magnetic material
- Recommended by the EMC/EMI directives
- Performs to the class C5 (very high) category as per ISO 12944-2
- EAC compliant
- RoHS compliant

CPIW GROUNDING AND BONDING BRAID SPECIFICATIONS

- Material: Stainless Steel 316L (EN 1.4404)
- Certification details: UL 467
- Complies with: IEC 61439-1

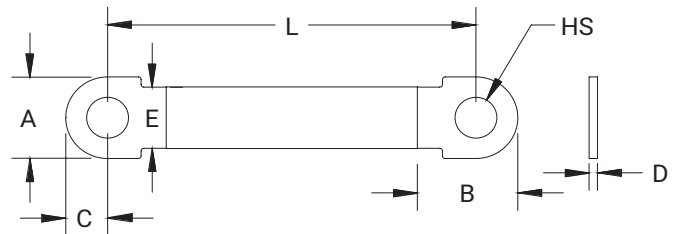

CPIW GROUNDING AND BONDING BRAID, TECHNICAL CHARACTERISTICS



Part No.	Article No.	Cross Section mm ²	L mm	HS mm	A mm	B mm	C mm	D mm	E mm	Unit Weight kg	Minimum Order Quantity
CPIW50-200-20B	554386B	50	200	21	42	51	21	3	30	0,128	50
CPIW50-200-24B	554401B	50	200	25	52	62	26	3	30	0,154	50
CPIW50-250-20B	554398B	50	250	21	42	51	21	3	30	0,148	50
CPIW50-250-24B	554403B	50	250	25	52	62	26	3	30	0,176	50
CPIW50-250-27B	554405B	50	250	28	58	69	29	3	30	0,195	50
CPIW50-250-30B	554407B	50	250	31	62	74	31	3	30	0,207	50
CPIW50-300-20B	554427B	50	300	21	42	51	21	3	30	0,200	50
CPIW50-300-24B	554428B	50	300	25	52	62	26	3	30	0,210	50
CPIW50-300-27B	554429B	50	300	28	58	69	29	3	30	0,220	50
CPIW50-300-30B	554409B	50	300	31	62	74	31	3	30	0,229	50
CPIW50-300-33B	554412B	50	300	34	68	78	34	3	30	0,246	50
CPIW50-300-39B	554416B	50	300	40	78	89	39	3	30	0,284	50
CPIW50-300-42B	554421B	50	300	43	82	94	41	3	30	0,301	50
CPIW50-400-33B	554414B	50	400	34	68	78	34	3	30	0,288	50
CPIW50-400-39B	554418B	50	400	40	78	89	39	3	30	0,327	50
CPIW50-400-42B	554423B	50	400	43	82	94	41	3	30	0,344	50
CPIW70-200-20B	554397B	70	200	21	42	51	21	3	30	0,149	50
CPIW70-200-24B	554402B	70	200	25	52	62	26	3	30	0,175	50
CPIW70-250-20B	554399B	70	250	21	42	51	21	3	30	0,178	50
CPIW70-250-24B	554404B	70	250	25	52	62	26	3	30	0,203	50
CPIW70-250-27B	554406B	70	250	28	58	69	29	3	30	0,221	50
CPIW70-250-30B	554408B	70	250	31	62	74	31	3	30	0,233	50
CPIW70-300-30B	554411B	70	300	31	62	74	31	3	30	0,262	50
CPIW70-300-33B	554413B	70	300	34	68	78	34	3	30	0,278	50
CPIW70-300-39B	554417B	70	300	40	78	89	39	3	30	0,315	50
CPIW70-300-42B	554422B	70	300	43	82	94	41	3	30	0,331	50
CPIW70-400-20B	554388B	70	400	21	42	51	21	3	30	0,264	50
CPIW70-400-33B	554415B	70	400	34	68	78	34	3	30	0,336	50
CPIW70-400-39B	554419B	70	400	40	78	89	39	3	30	0,373	50
CPIW70-400-42B	554424B	70	400	43	82	94	41	3	30	0,389	50

Power Shunt (PBC)



- High flexibility
- Reduce vibrations
- Ideal for transformer-busduct link
- Intensity: Up to 4600 A

PBC FEATURES

- Undrilled palms to customer's specific designs, fitted by power press
- Extra-flexible power connections (expansion rings, busbar...)
- Tinned electrolytic copper strand \varnothing 0,15 mm
- When used in parallel, the 2 shunts must be spaced with a minimum distance equal to the thickness of the shunt to allow air cooling

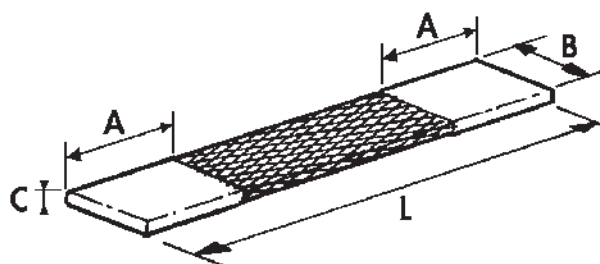

Part No.	Description	Section mm ²	Intensity (ΔT 30K)		Intensity (ΔT 50K)		A mm	B mm	C mm	L mm	Box	Kg
			↙	↘	↙	↘						
564000	PBC 100 x 250	100	349	600	462	795	35	40	7,0	250	2	0,38
564050	PBC 100 x 500	100	349	600	462	795	35	40	7,0	500	2	0,63
564010	PBC 120 x 250	120	385	670	511	877	35	40	7,5	250	2	0,42
564100	PBC 150 x 250	150	440	757	583	1003	55	50	8,0	250	2	0,63
564150	PBC 150 x 500	150	440	757	583	1003	55	50	8,0	500	2	0,90
564200	PBC 200 x 250	200	550	946	729	1253	55	50	9,0	250	2	0,76
564250	PBC 200 x 500	200	550	946	729	1253	55	50	9,0	500	2	1,20
564300	PBC 250 x 300	250	651	1120	863	1484	85	50	10,5	300	2	1,03
564400	PBC 300 x 400	300	716	1180	948	1565	85	60	11,0	400	1	1,53
564500	PBC 400 x 400	400	853	1360	1131	1808	85	80	11,0	400	1	2,20
564600	PBC 500 x 400	500	917	1561	1216	1944	105	100	11,0	400	1	2,64
564700	PBC 600 x 450	600	1101	1762	1459	2334	105	100	13,0	450	1	3,40
564800	PBC 800 x 450	800	1376	2202	1823	2917	105	100	14,0	450	1	4,26
564900	PBC 1000 x 450	1000	1651	2642	2188	3500	105	100	16,0	450	1	5,47
564030	PBC 1200 x 500	1200	1982	3170	2626	4208	125	120	17,5	500	1	7,16
564910	PBC 1500 X 800	1500	2300	3036	3048	4023	125	150	17,5	800	1	12,6

Presswelded Power Shunts (PPS)

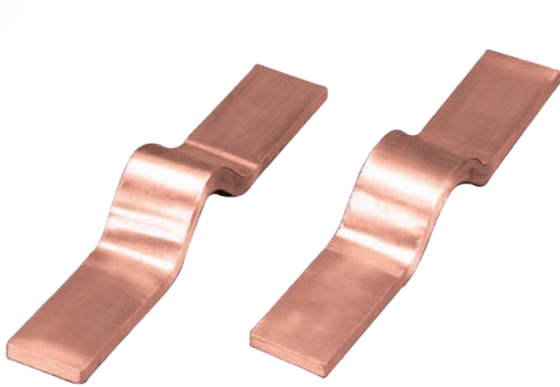

PPS FEATURES

Press welding is welding of laminations to each other through direct current applied to pieces under pressure.

This technique results in:

- The formation of a solid palm with properties of plain bar
- Smaller cross section for same capacity
- Runs cooler than equal section
- Plain copper, thickness of laminations 0,2 mm
- When used in parallel, the 2 shunts must be spaced with a minimum distance equal to the thickness of the shunt

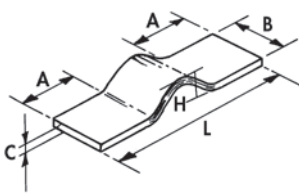

Part No.	Description	Section mm ²	Intensity (ΔT 30K)		Intensity (ΔT 50K)		A mm	B mm	C mm	L mm	H mm	Kg
			↙	↘	↙	↘						
566030	PPS 50/10/80-280	500	1022	1758	1354	2329	80	50	10	280	58	1,440
566040	PPS 80/10/100-320	800	1511	2493	2002	3303	100	80	10	320	52	2,625
566050	PPS 100/10/100-300	1000	1825	2920	2418	3869	100	100	10	300	54	3,065
566060	PPS 100/10/110-360	1000	1825	2920	2418	3869	110	100	10	360	53	3,610
566070	PPS 100/15/110-360	1500	2178	3485	2886	4617	110	100	15	360	57	5,385

CUSTOM SOLUTIONS

nVent ERIFLEX can provide made-to-order, custom configurations to your drawing specifications.

nVent ERIFLEX copper braids can be made to custom lengths, widths, thicknesses and hole patterns; with PVC installation; in flat or tubular shapes; using copper wire; in continuous coils; or with soldered studs or crimped lugs. Let nVent ERIFLEX solve your design and production scheduling challenges.



Flat Copper & Stainless Steel Braids (FTCB, FRCB, FSSB & FTCBI)

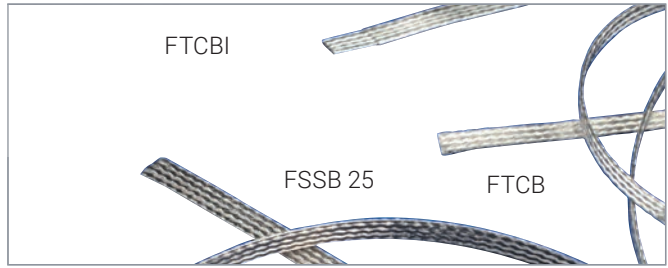
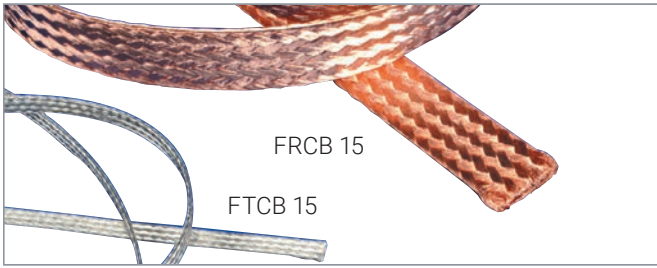

FTCB 15 FLAT TINNED COPPER BRAIDS



- Standard wire diameter: 0,15 mm
- 25 m coils

Part No.	Description	Section mm ²	mm	Number of Wire	Nominal Current A			Kg
557200	FTCB 15-3	3	5x1	168	30	25 m	0,03	
557210	FTCB 15-5	5	8x1	288	45	25 m	0,05	
557220	FTCB 15-8	8	8x1,5	456	65	25 m	0,08	
557230	FTCB 15-10	10	10x1,5	576	75	25 m	0,10	
557240	FTCB 15-16	16	15x1,5	896	120	25 m	0,16	
557250	FTCB 15-20	20	20x1,5	1120	140	25 m	0,20	
557260	FTCB 15-25	25	19,5x1,9	1404	150	25 m	0,25	
557270	FTCB 15-30	30	23x2,0	1692	180	25 m	0,30	
557280	FTCB 15-35	35	23x2,5	1980	200	25 m	0,35	
557290	FTCB 15-40	40	25x2,5	2272	220	25 m	0,40	
557300	FTCB 15-50	50	28x3	2848	250	25 m	0,50	
557310	FTCB 15-60	60	30x3	3392	280	25 m	0,60	
557320	FTCB 15-70	70	30x3,5	3968	290	25 m	0,70	
557330	FTCB 15-75	75	30x4	4256	300	25 m	0,75	
557350	FTCB 15-100	100	40x4	5664	360	25 m	1,00	

FRCB 15 FLAT PLAIN COPPER BRAIDS

- Standard wire diameter: 0,15 mm
- 25 m coils

Part No.	Description	Section mm ²	mm	Number of Wire	Nominal Current A			Kg
557010	FRCB 15-5	5	8x1	288	45	25 m	0,05	
557030	FRCB 15-10	10	10x1,5	576	75	25 m	0,10	
557040	FRCB 15-16	16	15x1,5	896	120	25 m	0,16	
557060	FRCB 15-25	25	23x1,5	1404	150	25 m	0,25	
557080	FRCB 15-35	35	23x2,5	1980	200	25 m	0,35	
557090	FRCB 15-40	40	25x2,5	2272	220	25 m	0,40	
557100	FRCB 15-50	50	28x3	2848	250	25 m	0,50	
557130	FRCB 15-75	75	30x4	4256	300	25 m	0,75	
557150	FRCB 15-100	100	40x4	5664	360	25 m	1,00	

FTCBI INSULATED FLAT TINNED COPPER BRAIDS

- Insulation in clear PVC, thickness 1 mm, self-extinguishing UL 94-VO
- Standard wire diameter: 0,15 mm
- 25 m coils
- Insulation voltage: 450 V
- Working temperature: up to 70°C

Part No.	Description	Section mm ²	mm	Number of Wire	Nominal Current A			Kg
510300	FTCBI 16	16	17x3,5	896	120	25 m	0,18	
510310	FTCBI 25	25	24,5x5,9	1404	150	25 m	0,29	
510340	FTCBI 50	50	30x5	2848	250	25 m	0,60	

FTCB 20 FLAT TINNED COPPER BRAIDS



- Standard wire diameter: 0,20 mm
- Extra long reels

Part No.	Description	Section mm ²	mm	Number of Wire	Nominal Current A			Kg
503510	FTCB 20-5	5	8x1	168	45	500 m	0,05	
503520	FTCB 20-10	10	10x1,5	312	75	150 m	0,10	
503530	FTCB 20-16	16	15x2	512	120	150 m	0,16	
503540	FTCB 20-25	25	19,5x1,9	792	150	100 m	0,25	

FSSB 25 STAINLESS STEEL FLAT BRAIDS



- Standard wire diameter: 0,25 mm
- Stainless steel 316L

Part No.	Description	Section mm ²	mm			Kg
557160	FSSB 25-16 ²	16	15x1,5	25 m	0,14	
557170	FSSB 25-25 ²	25	23x1,5	25 m	0,22	
557390	FSSB 25-50 ²	50	30x3	25 m	0,44	

Round & Tubular Copper Braids (RTCB, RRCB, RRCT, TTCE)

- A large range of braids
- Bare or insulated

- Tubulars for shielding
- Stainless steel for corrosive environment

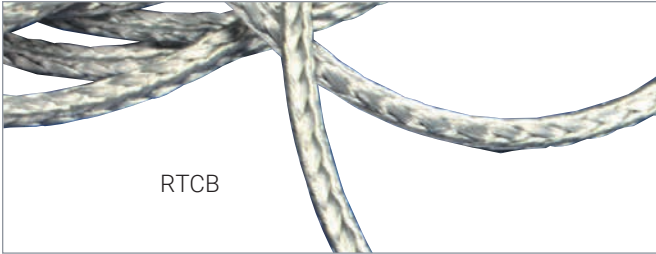

RTCB

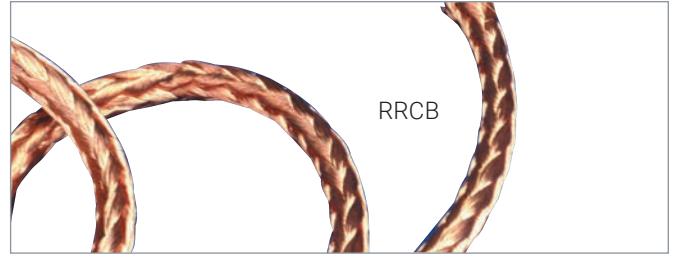

RRCB

RTCB / RTCB HL TINNED COPPER ROUND BRAIDS



Part No.	Description	Section mm ²	External dia in mm	Number of Wire	Nominal Current A		
557600	RTCB 15-6	6	4	352	45	25 m	0,06
557610	RTCB 15-8	8	4,5	464	65	25 m	0,08
557620	RTCB 15-10	10	5	560	75	25 m	0,10
557630	RTCB 15-16	16	6	900	120	25 m	0,16
557640	RTCB 15-25	25	8	1416	150	25 m	0,25
557650	RTCB 15-30	30	9	1680	180	25 m	0,30
557660	RTCB 15-50	50	11	2820	250	25 m	0,50
557670	RTCB 15-75	75	13,5	4236	300	25 m	0,75
557680	RTCB 15-100	100	17	5652	360	25 m	1,00
Standard wire diameter 0,15 mm - Extra long reels							
503700	RTCB 15-10/HL	10	5	560	75	100 m	0,100
503710	RTCB 15-16/HL	16	6	900	120	100 m	0,160
503720	RTCB 15-25/HL	25	7,5	1416	150	100 m	0,250

RRCB PLAIN COPPER ROUND BRAIDS

- Standard wire diameter: 0,15 mm
- 25 m coils

Part No.	Description	Section mm ²	External dia in mm	Number of Wire	Nominal Current A		
557400	RRCB 15-6	6	4	352	45	25 m	0,06
557420	RRCB 15-10	10	5	560	75	25 m	0,10
557430	RRCB 15-16	16	6	900	120	25 m	0,16
557440	RRCB 15-25	25	8	1416	150	25 m	0,25
557450	RRCB 15-30	30	9	1680	180	25 m	0,30
557460	RRCB 15-50	50	11	2820	250	25 m	0,50
557470	RRCB 15-75	75	14	4236	300	25 m	0,75
557480	RRCB 15-100	100	18	5652	360	25 m	1,00

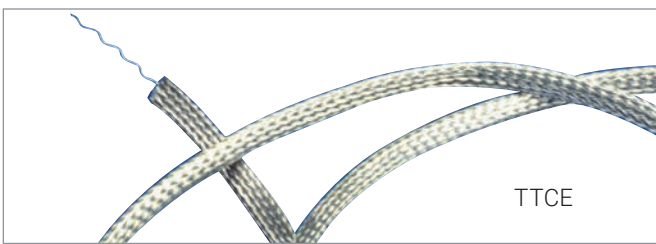

TTCE

TTCE TINNED COPPER TUBULAR BRAIDS

- For screening connecting cables between equipment used in an electromagnetically disturbed environment.
- Supplied with draw wire

Part No.	Description	Section mm ²	Diameter mm				Number of Wire	Ø wires mm	Nominal Current A		
			Int.	Covering %	Exp.	Covering %					
510100	TTCE 3	1,7	3	100%	6	90%	96	0,15	13	50 m	0,020
510110	TTCE 5	2,5	5	99%	10	92%	144	0,15	19	50 m	0,026
510120	TTCE 8	4,45	8	99%	16	95%	252	0,15	37	50 m	0,050
510130	TTCE 10	5,7	10	100%	20	92%	320	0,15	43	50 m	0,054
510140	TTCE 15	12	15	100%	25	94%	334	0,15	90	50 m	0,120
510150	TTCE 20	20,4	20	99%	40	87%	288	0,30	122	50 m	0,190
510160	TTCE 25	27,1	25	99%	50	92%	384	0,30	163	25 m	0,270
510170	TTCE 30	33,9	30	100%	60	90%	480	0,30	185	25 m	0,320
510180	TTCE 35	40,7	35	100%	70	94%	576	0,30	244	25 m	0,380

The primary use of tubular braid is to provide sensitive cables with an EMC/EMI screen to shield them against electromagnetic, electrostatic and radio frequency interference. Optimum screening performance is obtained using copper wire braid that can also be used for earth continuity purposes.

Round Copper Braids (RRCBI & RTCBI)

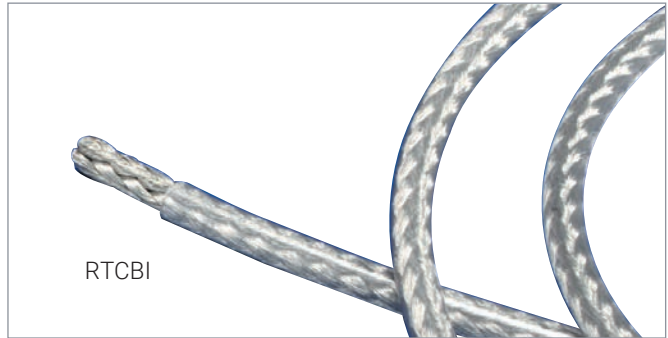
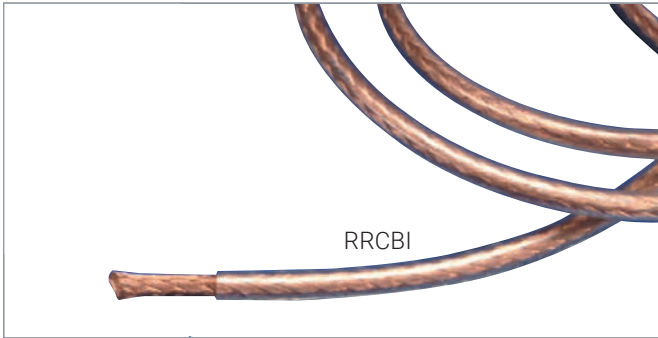





RRCBI INSULATED PLAIN COPPER ROUND BRAIDS

- Insulation in clear PVC, thickness 1 mm, self-extinguishing UL 94 - VO
- Standard wire diameter: 0,15 mm
- Insulation voltage: 450 V
- Working temperature: up to 70°C

RTCBI / RTCBI HL INSULATED ROUND TINNED COPPER BRAIDS

- Insulation in clear PVC, thickness 1 mm, self-extinguishing UL 94 - VO
- Standard wire diameter: 0,15 mm
- 25 m coils
- Insulation voltage: 450 V
- Working temperature: up to 70°C

Part No.	Description	Section mm ²	External dia in mm	Number of Wire	Nominal Current A	 25 m	 Kg
510500	RRCBI 15-10	10	7	560	75	25 m	0,10
510510	RRCBI 15-16	16	8	900	120	25 m	0,16

Part No.	Description	Section mm ²	mm	Number of Wire	Nominal Current A	 25 m	 Kg
503400	RTCBI 15-10	10	7	560	75	25 m	0,12
503410	RTCBI 15-16	16	8	900	120	25 m	0,18
503420	RTCBI 15-25	25	9,5	1416	150	25 m	0,25
503430	RTCBI 15-30	30	10	1680	180	25 m	0,35
503440	RTCBI 15-50	50	12,5	2820	250	25 m	0,58

ON REQUEST SPECIAL MANUFACTURING:

- Tubular braids up to 60 mm diameter maximum
- Flat or round copper braids up to 400 mm² maximum
- Insulation 105°C





Make Your Own Braided Connections



BD CRIMP AND DRILL TOOL

- This tool has been developed by nVent ERIFLEX specifically for crimping and drilling of braid terminals. Guide and specially adapted drill bit included.

Part No.	Description	For Flat	Ø Drill Bit	Bolt	 Kg	
558610	BD 16	FTCB or FRCB 15-16	6,5	M6	1	0,653
558640	BD 16-8,5	FTCB or FRCB 15-16	8,5	M8	1	0,653
558620	BD 25	FTCB or FRCB 15-25	11	M10	1	0,678
558630	BD 50	FTCB or FRCB 15-50	12,5	M126	1	0,712

HCT 3-4 CRIMPING TOOL FOR HYDRAULIC WORK CENTER



- This package allows to crimp lugs PB16, PB25 and PB50 on braids with the hydraulic nVent ERIFLEX Puncher.

Part No.	Description		 Kg
545980	HCT 3-4	1	1,850

PB LUGS FOR FLAT BRAIDS (FTCB OR FRCB)

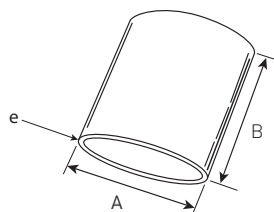
- In tinned annealed copper



Part No.	Description	For Flat	A	B	e		 Kg
557180	PB 16	FTCB or FRCB 15-16	16	15	1	100	0,004
557190	PB 25	FTCB or FRCB 15-25	22	25	1	100	0,010
557380	PB 50	FTCB or FRCB 15-50	30	30	1	100	0,017

ABOUT ELECTROMAGNETIC COMPATIBILITY

In an environment where electromagnetic disturbances are more and more numerous, the ElectroMagnetic Compatibility (EMC) is increasingly important in the design and building of electrical panels.

In order to avoid stray currents, it is necessary that all the metallic framework, inside the panel or outside, is at the same electrical potential. Thus, it is essential to link all these metal parts with connections presenting a low impedance at High Frequency (H.F.).

Connections with cables are not efficient. Only short and flat conductors are. Their H.F. impedances are 10 times lower than the wire impedances.

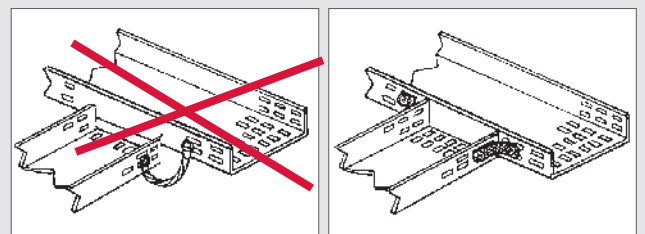
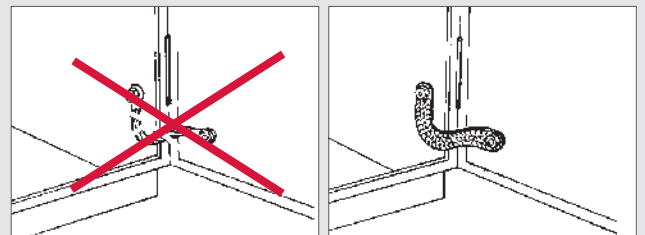

Made to Order Solutions (MTO)

FLEXIBAR CUSTOM SOLUTIONS (MADE TO ORDER)

nVent ERIFLEX can provide preformed Flexibar configurations to your drawing specifications. Flexibar can be cut, punched, twisted or bent to address your most challenging panelboard designs and production scheduling requirements. Give nVent ERIFLEX your low voltage connection challenges!

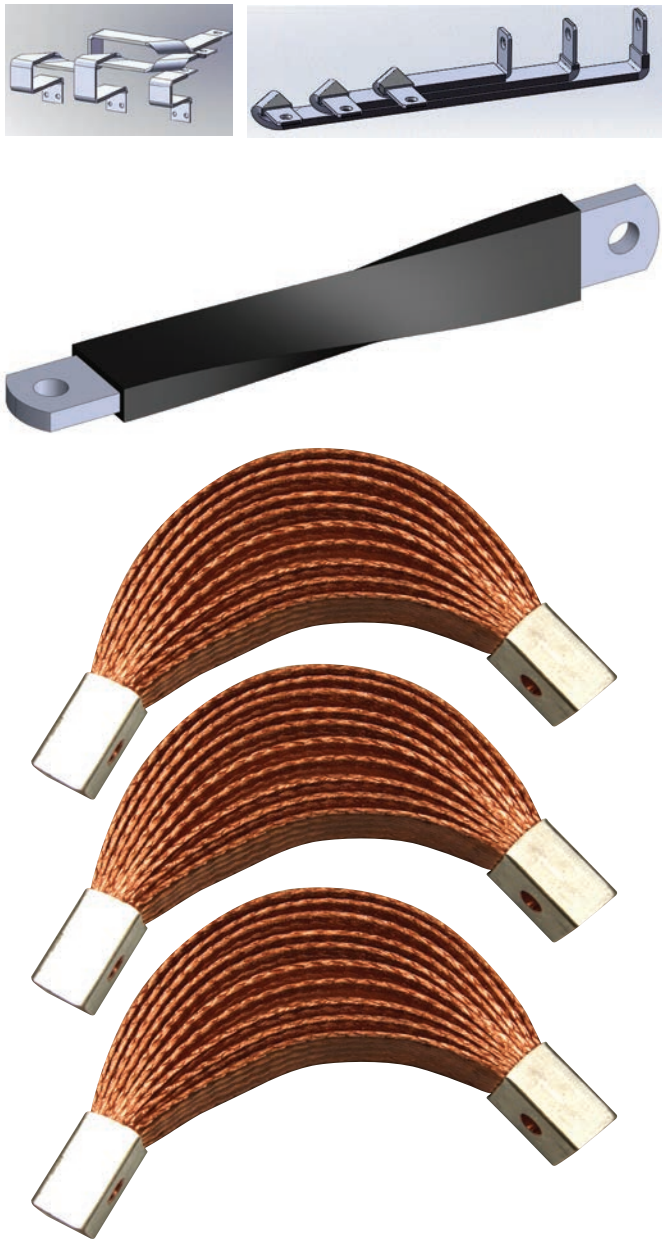

BRAIDED CONDUCTORS CUSTOM SOLUTIONS (MADE TO ORDER)

nVent ERIFLEX brand of copper braids can be made to custom lengths, widths, thicknesses and hole patterns; with PVC or TPE (Advanced) insulation; in flat or tubular shapes; using copper or stainless steel wire; in continuous coils; or with soldered studs or crimped lugs. Let nVent ERIFLEX solve your design and production scheduling challenges.



Made to Order Solutions

CUSTOM SOLUTIONS (MADE TO ORDER) - CHECK LIST

Summary of the information we need for custom design work. Please photocopy this page and complete it by providing the information you know and sending to your local nVent ERIFLEX customer service representative. (Sections can be left blank)

Electrical Function:

Earthing/grounding conductor.....
 Power conductor.....
 Nominal current..... ___A
 Alternating or direct current..... ___
 Nominal voltage..... ___V
 Insulation specification (if require).....

Material:

Red/plain copper.....
 Tinned copper.....
 Stainless steel.....
 Aluminum.....
 Other.....

Environment:

Ambient temperature..... °C
 Operating temperature..... °C
 Conductor maximum temperature..... °C
 Humidity (dry/average/moist)..... %HR

EXTREMITY/TERMINAL DIMENSIONS:

Indicate your dimensions on the proposed terminal drawing or make a sketch showing your needs.

The image shows five technical drawings of terminal cross-sections with dimension lines. The first three drawings show terminals with one, two, and three circular conductors. The fourth drawing shows a terminal with a single oval conductor. The fifth drawing shows a terminal with a rectangular conductor. To the right of these drawings is a large grid for sketching dimensions.

Conductor Dimensions:
 Availability: Drawing Specification Samples
 Cross Section _____ mm²
 Flat or Round Section _____
 Width of the Conductor _____ mm
 Thickness of the Conductor _____ mm
 Length of the Conductor _____ mm
 Quantity _____

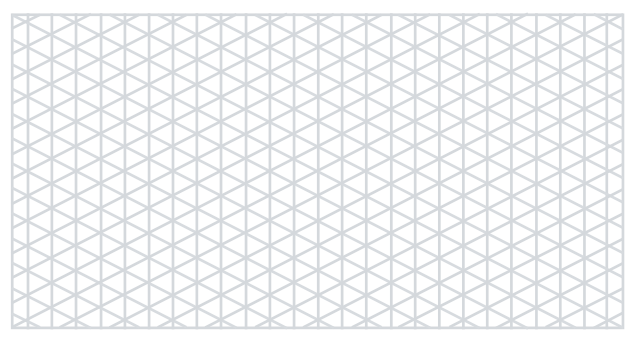

Contact/Requested by:

Company _____ E-mail address _____
 Contact Name _____ Address (City & Country) _____
 Phone Number _____

Cross Reference List

Part Number	Page
503400	46
503410	46
503420	46
503430	46
503440	46
503510	44
503520	44
503530	44
503540	44
503700	45
503710	45
503720	45
510100	45
510110	45
510120	45
510130	45
510140	45
510150	45
510160	45
510170	45
510180	45
510300	44
510310	44
510340	44
510500	46
510510	46
534000	13
534000	15
534001	13
534001	15
534002	13
534002	15
534003	13
534003	15
534004	13
534004	15
534005	13
534005	15
534006	13
534006	15
534007	13
534007	15
534008	13
534008	15
534009	13
534009	15
534010	13
534010	15
534011	13
534011	15

Part Number	Page
534012	13
534012	15
534013	13
534013*	15
534014	13
534014*	15
534015	13
534015*	15
534016	13
534016	15
534017	13
534017	15
534018	13
534018	15
534019	13
534019*	15
534020	13
534020*	15
534021	13
534021*	15
534022	13
534022*	15
534023	13
534023	15
534024	13
534024	15
534025	13
534025	15
534026	13
534026*	15
534027	13
534027*	15
534028	13
534028*	15
534029	13
534029*	15
534030	13
534030	15
534031	13
534031	15
534032	13
534032	15
534033	13
534033*	15
534034	13
534034*	15
534035	13
534035*	15
534036	13
534036*	15

Part Number	Page
534037	13
534037	15
534038	13
534038*	15
534039	13
534039*	15
534040	13
534040*	15
534041	13
534041*	15
534042	13
534042*	15
534044	13
534044*	15
534045	13
534045*	15
534046	13
534046*	15
534047	13
534047*	15
534048	13
534048*	15
534049	13
534049*	15
534050	13
534050*	15
534051	13
534051*	15
534052	13
534052*	15
534053	13
534053*	15
534055	13
534055*	15
534056	13
534056*	15
534057	13
534057*	15
534058	13
534058*	15
534059	13
534059*	15
534060	13
534060*	15
534400	26
534401	26
534402	26
534403	26
534404	26
534405	26

Cross Reference List

Part Number	Page
534406	26
534407	26
534408	26
534409	26
534410	26
534411	26
534412	26
534413	26
534414	26
534415	26
534416	26
534417	26
534418	26
534419	26
534420	26
534421	26
534422	26
534423	26
534424	26
534425	26
534426	26
534427	26
534428	26
534429	26
534430	26
534431	26
534432	26
534433	26
534434	26
534435	26
534436	26
534437	26
534438	26
534439	26
534440	26
534441	26
534442	26
534443	26
534444	26
534445	26
534446	26
534500	26
534501	26
534502	26
534503	26
534504	26
534505	26
534506	26
534507	26
534508	26

Part Number	Page
534509	26
534510	26
534511	26
534512	26
534513	26
534514	30
534515	30
534516	30
534517	30
534518	30
534519	30
534520	30
534521	30
534522	30
534523	30
534524	30
534525	30
534526	30
534527	30
534528	30
534529	30
534530	30
534531	30
534800	17
534805	17
534810	17
534815	17
541774	17
541775	17
541776	17
541800	17
541805	17
541810	17
541815	17
545980	47
553020	19
553030	19
553040	19
553050	19
553060	19
553070	19
553100	19
553110	19
553120	19
553200	19
553210	19
553220	19
553230	19
553250	19
553260	19

Part Number	Page
553370	18
553380	18
553400	20
553405	20
553410	20
553430	20
553440	20
553505	20
553510	20
553520	20
553530	20
553540	20
553550	18
553550	33
553560	18
553560	33
553570	18
553580	18
553590	18
554277	39
554278	39
554279	39
554280	39
554282	39
554286	39
554299	39
554300	39
554301	39
554302	39
554304	39
554308	39
554321	39
554322	39
554323	39
554324	39
554326	39
554330	39
554343	39
554344	39
554345	39
554346	39
554348	39
554352	39
554365	39
554366	39
554367	39
554368	39
554370	39
554374	39
554378	39

Cross Reference List

Part Number	Page
554384	39
554386B	41
554388B	41
554397B	41
554398B	41
554399B	41
554401B	41
554402B	41
554403B	41
554404B	41
554405B	41
554406B	41
554407B	41
554408B	41
554409B	41
554411B	41
554412B	41
554413B	41
554414B	41
554415B	41
554416B	41
554417B	41
554418B	41
554419B	41
554421B	41
554422B	41
554423B	41
554424B	41
554427B	41
554428B	41
554429B	41
555200	35
555201	35
556600	35
556610	35
556620	35
556630	35
556640	35
556650	35
556660	35
556670	35
556680	35
556690	35
556700	35
556710	35
556720	35
556730	35
556740	35
556750	35
556760	35

Part Number	Page
556770	35
556780	35
556790	35
556800	35
556810	35
556820	35
556830	35
556840	35
556850	35
556860	35
556900	34
556910	34
556920	34
556930	35
556940	35
556950	35
556960	35
556970	35
556980	35
557010	44
557030	44
557040	44
557060	44
557080	44
557090	44
557100	44
557130	44
557150	44
557160	44
557170	44
557180	47
557190	47
557200	44
557210	44
557220	44
557230	44
557240	44
557250	44
557260	44
557270	44
557280	44
557290	44
557300	44
557310	44
557320	44
557330	44
557350	44
557380	47
557390	44
557400	45

Part Number	Page
557420	45
557430	45
557440	45
557450	45
557460	45
557470	45
557480	45
557600	45
557610	45
557620	45
557630	45
557640	45
557650	45
557660	45
557670	45
557680	45
558310	20
558340	20
558370	20
558410	20
558440	20
558460	20
558480	20
558490	20
558584	32
558586	32
558587	32
558588	32
558589	32
558591	32
558592	32
558593	32
558594	32
558595	32
558610	47
558620	47
558630	47
558640	47
561210	20
561220	20
563300	35
563320	35
563340	35
563350	35
563360	35
563370	35
563380	35
563390	35
563400	35
563410	35

Cross Reference List

Part Number	Page
563420	35
563430	35
563440	35
563450	35
563460	35
563470	35
563480	35
563490	35
563500	35
563510	35
563520	35
563530	35
563540	35
563550	35
563560	35
563601	37
563602	37
563603	37
563604	37
563605	37
563606	37
563607	37
563608	37
563609	37
563611	37
563612	37
563613	37
563614	37
563615	37
563616	37
563617	37
563618	37
563619	37
563621	37
563622	37
564000	42
564010	42
564030	42
564050	42
564100	42
564150	42
564200	42
564250	42
564300	42
564400	42
564500	42
564600	42
564700	42
564800	42
564900	42

Part Number	Page
564910	42
565000	35
566030	43
566040	43
566050	43
566060	43
566070	43
567880	20
568700	19
568730	19
534110	16
534111	16
534116	16
534112	16
534113	16
534114	16
534117	16
534118	16
534123	16
534124	16
534119	16
534120	16
534125	16
534131	16
534137	16
534126	16
534127	16
534138	16
534128	16
534134	16
534139	16

OTHER LITERATURE

DISTRIBUTION BLOCKS, POWER BLOCKS AND DISTRIBUTION TERMINAL

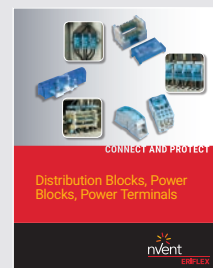

HYDRAULIC & MANUAL TOOLS



SOLUTIONS FOR ELECTRICAL POWER & EARTH CONNECTIONS



READY-TO-USE POWER CONDUCTOR: IBS & IBSB ADVANCED TECHNICAL GUIDE



NVENT ERIFLEX FLEXIBAR TECHNICAL HANDBOOK

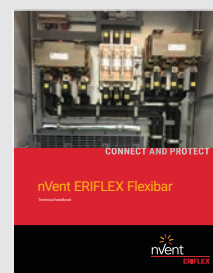

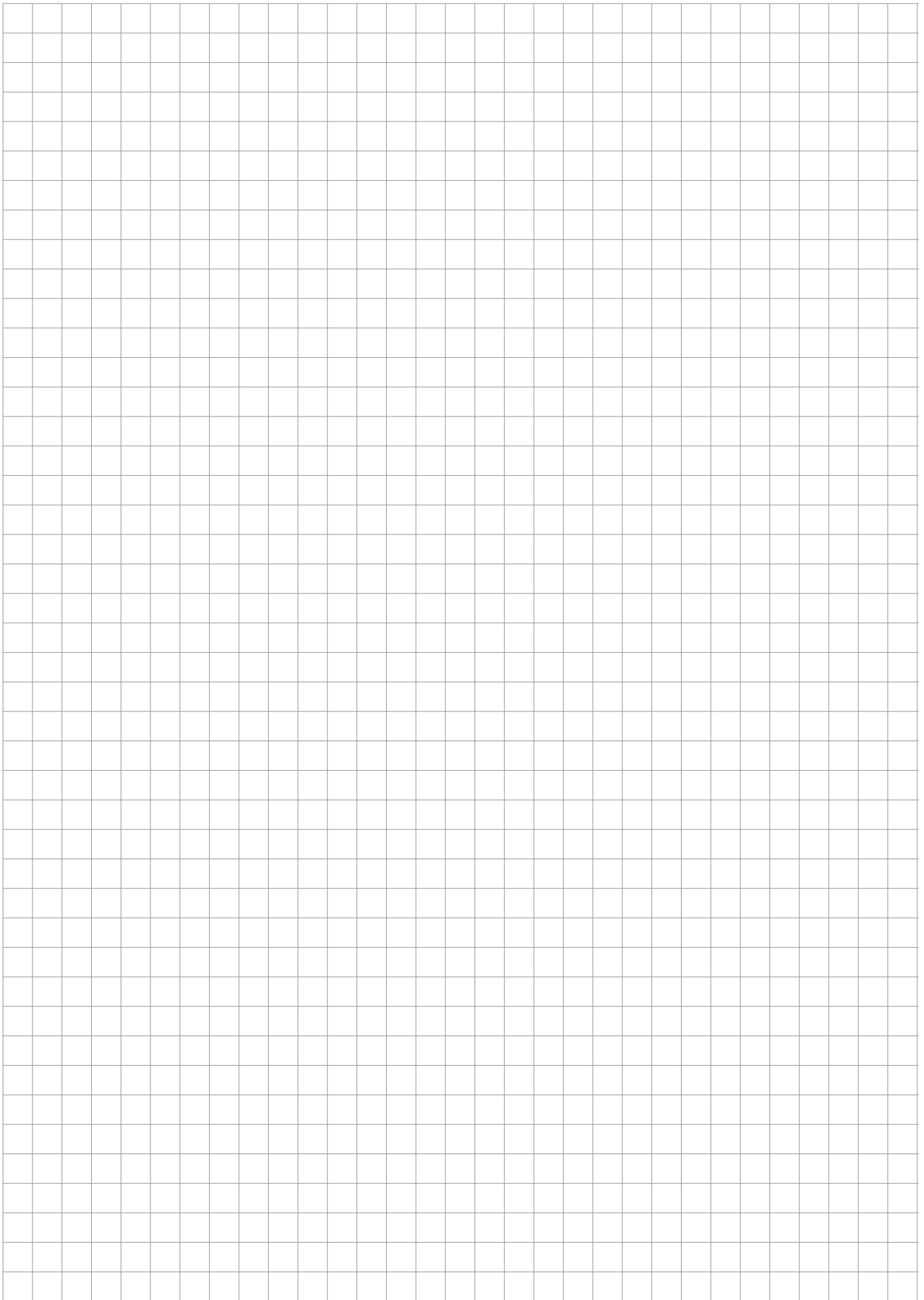

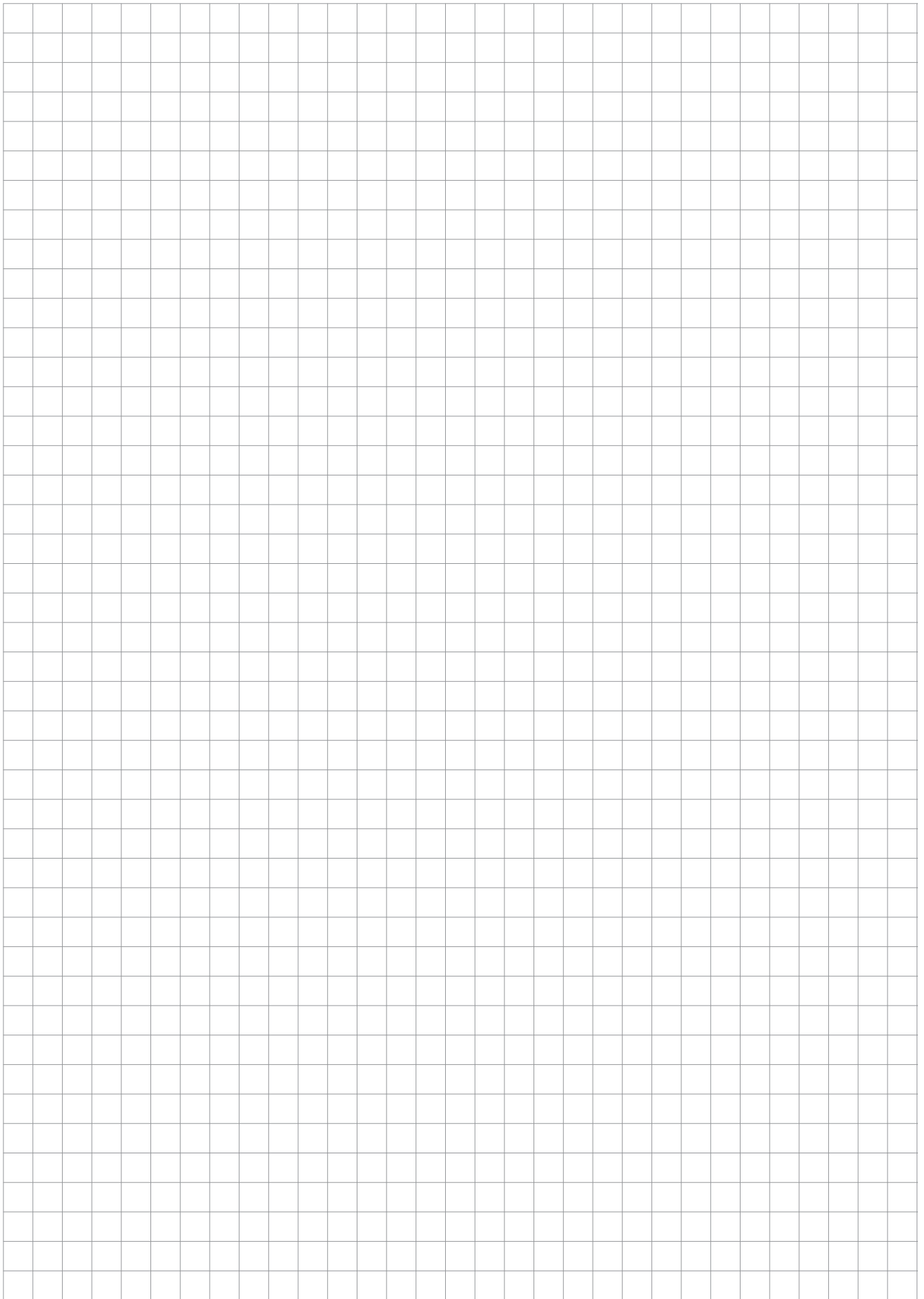

Our powerful portfolio of brands:

CADDY ERICO HOFFMAN RAYCHEM SCHROFF TRACER



[nVent.com/ERIFLEX](https://www.nvent.com/ERIFLEX)